



micro neuro surgery instruments



Sehr geehrter Geschäftspartner,

RZ-Medical Supply ist stolz, Ihnen ein umfangreiches Sortiment an Micro-Neuro Chirurgischen Instrumenten vorzustellen.

Wir wissen, daß wir nicht die Ersten in diesem Bereich sind, aber wir haben uns Zeit gelassen um die Nachfrage auf den Weltmärkten gründlich zu analysieren.

Wir hoffen, daß die Zeit des Wartens sich gelohnt hat und Sie auch Ihre Micro-Neuro Instrumente in unserem Katalog finden.

Sollten Sie Ihre bevorzugten Instrumente dennoch nicht finden, dann setzen Sie sich bitte mit uns in Verbindung, damit wir Ihnen behilflich sein können.

Hiermit setzen wir unsere Firmenphilosophie fort, hochqualitative Produkte zu fairen Preisen zu liefern.

Dear Business Partner,

RZ-Medical Supply is proud to introduce an extensive line of Micro-Neuro Surgical Instruments.

We know we were not the first on the market, but we have taken our time to analyse the needs of the surgeons in the world markets thoroughly.

We hope you feel results are worth the wait and you find your Micro-Neuro Surgical Instruments in our catalogue.

Should there be one of your favoured instrument you cannot find, please feel free to contact us in order to serve your needs.

We have continued our company's philosophy of high quality products of fair prices.

Mikro-Federscheren, bajonettförmig
Micro Scissors (Spring Type), bayonet-shaped



Artikel-Nr. Cat. No.	Gesamtlänge Total length			
250-064-038	225 mm / 9"			
250-064-060	225 mm / 9"	Schneiden gezahnt toothed blades	YASARGIL	
250-064-037	225 mm / 9"		VANNAS	
250-064-039	225 mm / 9"		YASARGIL	
250-064-061	245 mm / 9 3/4"			
250-064-040	225 mm / 9"		VANNAS	
250-064-047	225 mm / 9"		YASARGIL	
250-064-044	225 mm / 9"	Präparierschere Dissecting Scissors	YASARGIL	
250-064-043	225 mm / 9"	Präparierschere Dissecting Scissors	YASARGIL	

1/1

YASARGIL
 250-064-039
 225 mm
 9"



Mikro-Federscheren, bajonettförmig
Micro Scissors (Spring Type), bayonet-shaped

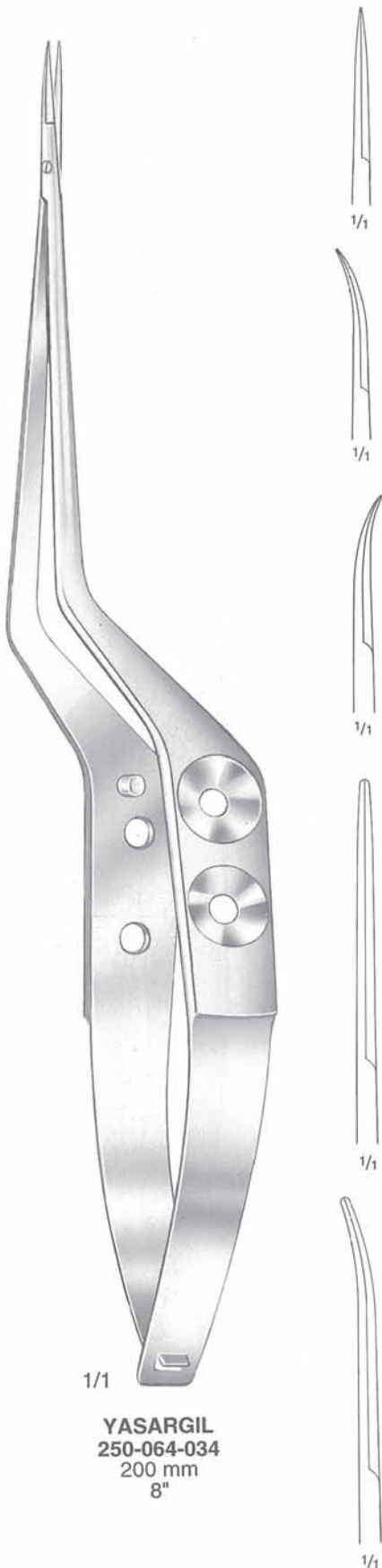

1/1

YASARGIL
250-064-034
 200 mm
 8"

	Artikel-Nr. Cat. No.	Gesamtlänge Total length
YASARGIL	250-064-030	165 mm / 6½"
	250-064-034	200 mm / 8"
YASARGIL	250-064-031	165 mm / 6½"
	250-064-035	200 mm / 8"
YASARGIL	250-064-036	200 mm / 8"
YASARGIL	250-064-032	200 mm / 8" Präparierschere Dissecting Scissors
YASARGIL	250-064-033	200 mm / 8" Präparierschere Dissecting Scissors



Artikel-Nr.
 Cat. No.

Gesamtlänge
 Total length

250-064-092

200 mm / 8"

YASARGIL



250-064-096

225 mm / 9"

250-064-089

165 mm / 6½"

250-064-093

200 mm / 8"

YASARGIL



250-064-097

225 mm / 9"

250-064-099

245 mm / 9¾"



YASARGIL
 250-064-092
 200 mm
 8"



Mikro-Federscheren, bajonettförmig
Micro Scissors (Spring Type), bayonet-shaped



1/1

250-064-057
200 mm
8"



NAGEL

Artikel-Nr.
Cat. No.

250-064-056

Gesamtlänge
Total length

200 mm / 8"



250-064-057

200 mm / 8"

mit Knopf
with probe-pointed blade



250-064-059

190 mm / 7½"

Mikro-Federscheren, bajonettförmig
Micro Scissors (Spring Type), bayonet-shaped



Artikel-Nr. Cat. No.	Gesamtlänge Total length
250-064-105	190 mm / 7½"
250-064-106	190 mm / 7½"
250-064-107	190 mm / 7½"
250-064-108	190 mm / 7½"

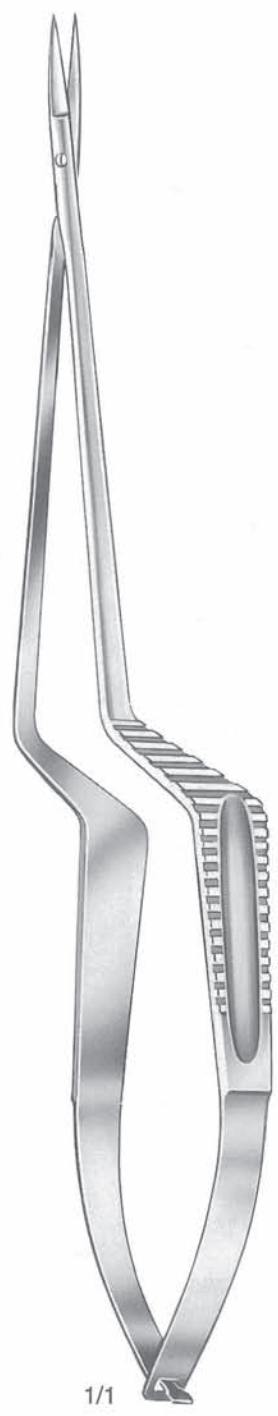
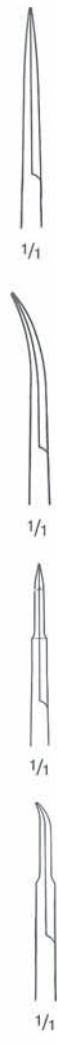

250-064-105
190 mm
7 ½"



**Mikro-Nadelhalter
Micro Needle Holders**



1/1

250-069-079
160 mm
6 1/4"



1/1



1/1



1/1



1/1

Artikel-Nr.
Cat. No.

Gesamtlänge
Total length

250-069-076

160 mm / 6 1/4"

250-069-080

185 mm / 7 1/4"

ohne Sperre
without catch

250-269-076

160 mm / 6 1/4"

250-269-080

185 mm / 7 1/4"

RZ-Diamant Dust beschichtet
RZ-Diamond dust coated

250-069-079

160 mm / 6 1/4"

250-069-081

185 mm / 7 1/4"

ohne Sperre
without catch

250-269-079

160 mm / 6 1/4"

250-269-081

185 mm / 7 1/4"

RZ-Diamant Dust beschichtet
RZ-Diamond dust coated

RZ Diamond Dust coated

gerade
straight



1/1

gebogen
curved









1/1

Die RZ-Diamant Dust beschichtete Oberfläche erhöht die Schnittfestigkeit bei den Micro-Scheren und verändert die Oberflächenstruktur bei den Micro-Nadelhaltern, somit kann die Nähnadel besser während des Nahtvorgangs geführt werden.

The RZ-Diamond Dust coated surface improves the cutting of the Micro-Scissors and increases the durability. The coated surface improves suture holding characteristics on all Micro Needle Holders.

**Mikro-Federscheren
Micro Scissors (Spring Type)**



Artikel-Nr. Cat. No.	Gesamtlänge Total length			
250-069-012	120 mm / 4¾"			
250-069-016	160 mm / 6¼"		MILLES	
250-069-020	160 mm / 6¼"	Schneiden gezahnt toothed blades	YASARGIL	
250-069-022	185 mm / 7¼"			
250-069-013	120 mm / 4¾"			
250-069-017	160 mm / 6¼"		MILLES	
250-069-021	160 mm / 6¼"	Schneiden gezahnt toothed blades	JACOBSON	
250-069-023	185 mm / 7¼"			
250-069-014	120 mm / 4¾"			
250-069-018	160 mm / 6¼"		VANNAS	
250-069-015	120 mm / 4¾"			
250-069-019	160 mm / 6¼"		VANNAS	
250-069-028	130 mm / 5⅛"	Venenschere Vein Scissors		
250-069-011	120 mm / 4¾"			
250-069-024	185 mm / 7¼"			

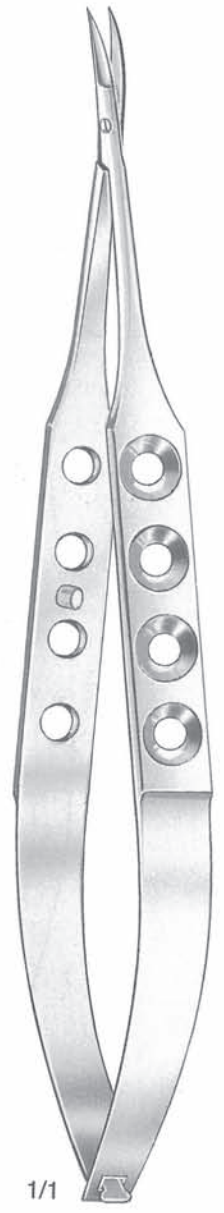

250-069-017
160 mm
6 ¼"



Mikro-Nadelhalter
Micro Needle Holders

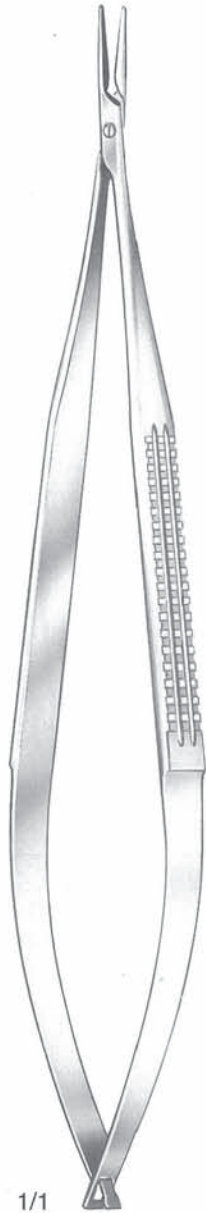

250-064-076
160 mm
6 1/4"



Artikel-Nr.
Cat. No.

Gesamtlänge
Total length

250-064-076

160 mm / 6 1/4"

250-064-080

185 mm / 7 1/4"
ohne Sperre
without catch

250-064-079

160 mm / 6 1/4"

250-064-081

185 mm / 7 1/4"
ohne Sperre
without catch

**Mikro-Federscheren
Micro Scissors (Spring Type)**



Artikel-Nr. Cat. No.	Gesamtlänge Total length			
250-064-012	120 mm / 4¾"			
250-064-016	160 mm / 6¼"			
250-064-020	160 mm / 6¼"	Schneiden gezahnt toothed blades	MILLES	
250-064-022	185 mm / 7¼"		YASARGIL	
250-064-013	120 mm / 4¾"			
250-064-017	160 mm / 6¼"			
250-064-021	160 mm / 6¼"	Schneiden gezahnt toothed blades	MILLES	
250-064-023	185 mm / 7¼"		JACOBSON	
250-064-014	120 mm / 4¾"		VANNAS	
250-064-018	160 mm / 6¼"			
250-064-015	120 mm / 4¾"		VANNAS	
250-064-019	160 mm / 6¼"			
250-064-028	130 mm / 5⅛"	Venenschere Vein Scissors	BIEMER	
250-064-011	120 mm / 4¾"		VANNAS	
250-064-024	185 mm / 7¼"		POTTS-YASARGIL	



Mikro-Nadelhalter
Micro Needle Holders



1/1

BARRAQUER
ohne Sperre
without catch
250-064-230
120 mm
4 3/4"



1/1

BARRAQUER
REILL

Artikel-Nr.
Cat. No.

Gesamtlänge
Total length

250-064-230

120 mm / 4 3/4"

250-064-240

150 mm / 6"

250-064-244

185 mm / 7 1/4"

250-064-260

210 mm / 8 1/4"

250-164-244

185 mm / 7 1/4"

250-164-260

210 mm / 8 1/4"

Titan, Titanium

ohne Sperre
without catch



1/1

BARRAQUER

250-064-231

120 mm / 4 3/4"

ohne Sperre
without catch



1/1

REILL

250-064-241

150 mm / 6"

250-064-245



185 mm / 7 1/4"

250-164-245

185 mm / 7 1/4"

Titan, Titanium

ohne Sperre
without catch

Artikel-Nr. Cat. No.	Gesamtlänge Total length		
250-064-232	120 mm / 4 ³ / ₄ "	BARRAQUER	 1/1
250-064-242	150 mm / 6"		
250-064-246	185 mm / 7 ¹ / ₄ "		
250-064-261	210 mm / 8 ¹ / ₄ "		
250-164-246	185 mm / 7 ¹ / ₄ "		
250-164-261	210 mm / 8 ¹ / ₄ " Titan, Titanium mit Sperre with catch		
250-064-233	120 mm / 4 ³ / ₄ " mit Sperre with catch	BARRAQUER	 1/1
250-164-247	185 mm / 7 ¹ / ₄ " Titan, Titanium mit Sperre with catch		
250-064-243	150 mm / 6"		
250-064-247	185 mm / 7 ¹ / ₄ "		
250-064-249	230 mm / 9"		



1/1

BARRAQUER
mit Sperre
with catch
250-064-232
120 mm
4³/₄"



Atrauma-Mikro Pinzetten
Atrauma-Micro Forceps



1/1

DE BAKEY
250-164-701
180 mm
7"

Atrauma-Mikro Pinzetten nach **DeBakey**, 8 mm Rundgriff
Atraumatic-Micro Forceps **DeBakey**, 8 mm round handle

Artikel-Nr. Cat. No.	Maulbreite jaw width	Länge length
250-064-701	1,2 mm	180 mm / 7"
250-064-702	2,0 mm	180 mm / 7"

250-164-701	1,2 mm	180 mm / 7"
250-164-702	1,8 mm	180 mm / 7"

Titan, Titanium

Atrauma-Mikro Pinzetten nach **DeBakey**, 8 mm Rundgriff,
mit Hartmetall Einlage, gerieft
Atraumatic-Micro Forceps **DeBakey**, 8 mm round handle,
with TC-inserts, serrated

Artikel-Nr. Cat. No.	Maulbreite jaw width	Länge length
250-064-703	1,2 mm	180 mm / 7"
250-064-704	1,8 mm	180 mm / 7"

Mikro-Ring Pinzette, 8 mm Rundgriff, gerieft
Micro-Ring Forceps, 8 mm round handle, serrated

Artikel-Nr. Cat. No.	Ringgröße ring size	Länge length
250-064-705 250-264-705	1 x 0,5 mm 1 x 0,5 mm RZ Diamond dust beschichtet RZ diamond dust coated	150 mm / 6"
250-064-706 250-264-706	2 x 1,0 mm 2 x 1,0 mm RZ Diamond dust beschichtet RZ diamond dust coated	180 mm / 7"
250-164-706 Titan, Titanium	2 x 1,0 mm	180 mm / 7"
250-364-706 Titan, Titanium	2 x 1,0 mm RZ Diamond dust beschichtet RZ diamond dust coated	180 mm / 7"
250-064-707 250-264-707	2 x 1,0 mm 2 x 1,0 mm RZ Diamond dust beschichtet RZ diamond dust coated	220 mm / 8 ³ / ₄ "
250-064-708 250-264-708	2 x 0,5 mm 2 x 0,5 mm RZ Diamond dust beschichtet RZ diamond dust coated	220 mm / 8 ³ / ₄ "



1/1

250-064-706
180 mm
7"



**Mikro-Federscheren
Micro Scissors (Spring Type)**



250-064-100
145 mm
5 3/4"



1/1



1/1



1/1



1/1

Artikel-Nr.
Cat. No.

Gesamtlänge
Total length

250-064-100

145 mm / 5 3/4"

250-064-600

180 mm / 7"

250-164-600

180 mm / 7"

Titan, Titanium

250-064-117

230 mm / 9"

250-064-101

145 mm / 5 3/4"

250-064-601

180 mm / 7"

250-164-601

180 mm / 7"

Titan, Titanium

250-064-103

145 mm / 5 3/4"

250-064-603

180 mm / 7"

Präparierschere
Dissecting Scissors

Mikro-Knüpfpinzetten
Micro Suture Tying Forceps



Artikel-Nr. Cat.No.	Gesamtlänge Total length		
250-064-280 250-264-280	120 mm / 4 3/4" 120 mm / 4 3/4" RZ Diamant dust beschichtet RZ diamond dust coated		
250-064-284 250-264-284	150 mm / 6" 150 mm / 6" RZ Diamant dust beschichtet RZ diamond dust coated		
250-164-284	150 mm / 6" Titan, Titanium		
250-364-284	150 mm / 6" Titan, Titanium RZ Diamant dust beschichtet RZ diamond dust coated		
250-064-286 250-264-286	180 mm / 7" 180 mm / 7" RZ Diamant dust beschichtet RZ diamond dust coated		
250-064-288 250-264-288	230 mm / 9" 230 mm / 9" RZ Diamant dust beschichtet RZ diamond dust coated		
250-164-286	180 mm / 7" Titan, Titanium		
250-364-286	180 mm / 7" Titan, Titanium RZ Diamant dust beschichtet RZ diamond dust coated		
250-064-281 250-264-281	120 mm / 4 3/4" 120 mm / 4 3/4" RZ Diamant dust beschichtet RZ diamond dust coated		
250-064-285 250-264-285	150 mm / 6" 150 mm / 6" RZ Diamant dust beschichtet RZ diamond dust coated		
250-164-285	150 mm / 6" Titan, Titanium		
250-364-285	150 mm / 6" Titan, Titanium RZ Diamant dust beschichtet RZ diamond dust coated		
250-064-287 250-264-287	180 mm / 7" 180 mm / 7" RZ Diamant dust beschichtet RZ diamond dust coated		
250-064-289 250-264-289	230 mm / 9" 230 mm / 9 " RZ Diamant dust beschichtet RZ diamond dust coated		
250-164-287	180 mm / 7" Titan, Titanium		
250-364-287	180 mm / 7" Titan, Titanium RZ Diamant dust beschichtet RZ diamond dust coated		

1/1
0,3 mm

1/1
0,6 mm

1/1
0,3 mm

1/1
0,6 mm

1/1
250-064-284
150 mm
6"



**Mikro-Nadelhalter
Micro Needle Holders**

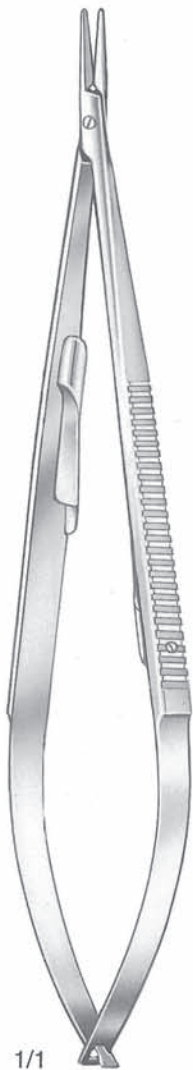

1/1

CASTROVIEJO
250-020-001
145 mm
5 3/4"



1/1

CASTROVIEJO

Artikel-Nr.
Cat. No.

250-020-001

Gesamtlänge
Total length

145 mm / 5 3/4"

Hartmetall
carbide inserts



1/1

CASTROVIEJO

250-020-002

250-020-004

250-020-005

145 mm / 5 3/4"

180 mm / 7"

215 mm / 8 1/2"

Hartmetall
carbide inserts



1/1

**CASTROVIEJO-
JACOBSON**

250-020-563

250-220-563

145 mm / 5 3/4"

145 mm / 5 3/4"

RZ Diamond dust beschichtet
RZ diamond dust coated



1/1

**CASTROVIEJO-
JACOBSON**

250-020-564

250-220-564

145 mm / 5 3/4"

145 mm / 5 3/4"

RZ Diamond dust beschichtet
RZ diamond dust coated



Artikel-Nr. Cat.No.		Gesamtlänge Total length
Jacobson Mikro Nadelhalter 1 mm Maul		180 mm / 7"
Jacobson Micro Needleholder 1 mm jaw		180 mm / 7"
mit Sperre with catch	ohne Sperre without catch	
250-064-049	250-064-048	180 mm / 7" gerade/straight
250-264-049	250-264-048	180 mm / 7" RZ Diamond dust beschichtet RZ diamond dust coated
250-064-051	250-064-050	180 mm / 7" gebogen/curved
250-264-051	250-264-050	180 mm / 7" RZ Diamond dust beschichtet RZ diamond dust coated
Jacobson Mikro Nadelhalter glattes Maul		180 mm / 7"
Jacobson Micro Needleholder smooth jaw		180 mm / 7"
mit Sperre with catch	ohne Sperre without catch	
250-064-046	250-064-045	180 mm / 7" gerade/straight
Jacobson Mikro Nadelhalter glattes Maul, Hartmetall-Einlagen		180 mm / 7"
Jacobson Micro Needleholder smooth jaw, with TC-inserts		180 mm / 7"
mit Sperre with catch	ohne Sperre without catch	
250-364-046	250-364-045	180 mm / 7"



1/1

JACOBSON
250-064-046
180 mm
7"



**Mikro-Federscheren
Micro Scissors (Spring Type)**



CASTROVIEJO
400-133-100
100 mm
4"

CASTROVIEJO

Artikel-Nr.
Cat. No.

Gesamtlänge
Total length

400-133-100

100 mm / 4"

spitz
sharp

CASTROVIEJO





400-135-100

100 mm / 4"

stumpf
blunt

**Mikro-Federscheren
Micro Scissors (Spring Type)**



Artikel-Nr. Cat. No.	Gesamtlänge Total length			
400-842-085	85 mm / 3 1/3"	VANNAS		
400-843-085	85 mm / 3 1/3"	VANNAS		
400-844-085	85 mm / 3 1/3"	VANNAS		

1/1

1/1

1/1

1/1

VANNAS
400-842-085
85 mm
3 1/3"



Mikro-Pinzetten, bajonettförmig
Micro Forceps, bayonet-shaped



1/1
YASARGIL
 250-024-840
 200 mm
 8"



YASARGIL

Artikel-Nr. Cat. No.	Gesamtlänge Total length
250-024-830	160 mm / 6¼"
250-024-835	180 mm / 7"
250-024-840	200 mm / 8"
250-024-845	220 mm / 8¾"
250-024-850	240 mm / 9½"
	Spitzen 0,6 mm Tips 0,6 mm



YASARGIL

250-024-831	160 mm / 6¼"
250-024-836	180 mm / 7"
250-024-841	200 mm / 8"
250-024-846	220 mm / 8¾"
250-024-851	240 mm / 9½"
	Spitzen 0,9 mm Tips 0,9 mm



YASARGIL

250-024-837	180 mm / 7"
	1 x 2 Zähne 1 x 2 teeth

alle Mikro-Pinzetten sind auch mit RZ-Diamond dust beschichteten Spitzen erhältlich
 all Micro Forceps holder are also available with RZ diamond dust coated tips

Pinzetten zum Fassen von Gewebe, Tumoren
 Forceps for grasping tissue, tumors



Artikel-Nr. Cat. No.	Gesamtlänge Total length			
250-064-210	220 mm / 8¾"	YASARGIL	Ø 3 mm	
250-064-200	240 mm / 9½"	YASARGIL-SAMII		
	Maul löffelförmig jaws spoon-shaped			
250-064-212	220 mm / 8¾"	YASARGIL	Ø 5 mm	
250-064-202	240 mm / 9½"	YASARGIL-SAMII		
	Maul löffelförmig jaws spoon-shaped			
250-064-204	240 mm / 9½"	YASARGIL-SAMII	Ø 7 mm	
	Maul löffelförmig jaws spoon-shaped			
250-064-214	220 mm / 8¾"	YASARGIL	Ø 3 mm	
	Maul flach, gezahnt flat jaws, serrated			
250-064-216	220 mm / 8¾"	YASARGIL	Ø 5 mm	
	Maul flach, gezahnt flat jaws, serrated			
250-064-215	220 mm / 8¾"	HEIFETZ	Ø 3 mm	
	Maul kürettenförmig Curette jaws, toothed			
250-064-217	220 mm / 8¾"	HEIFETZ	Ø 5 mm	
	Maul kürettenförmig Curette jaws, toothed			

alle Mikro-Pinzetten sind auch mit RZ-Diamond dust beschichteten Spitzen erhältlich
 all Micro Forceps holder are also available with RZ diamond dust coated tips

YASARGIL
 250-064-216
 220 mm
 8 ¾"



Pinzetten zum Fassen von Gewebe, Tumoren
Forceps for grasping tissue, tumors

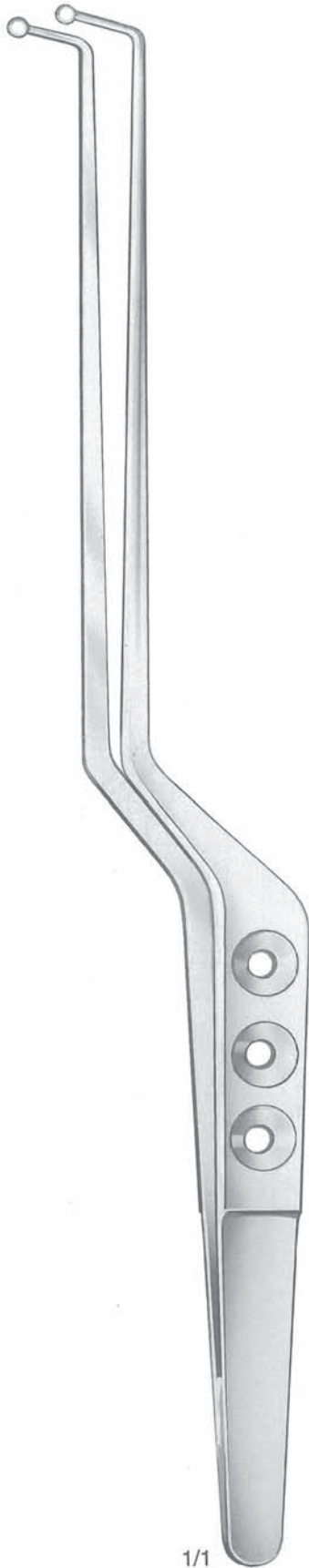

1/1

SAMII
250-064-190
 230 mm
 9"



SAMII

Artikel-Nr
 Cat. No.

250-064-190

Gesamtlänge
 Total length

230 mm / 9"

Maul löffelförmig
 jaws spoon-shaped



SAMII

250-064-191

230 mm / 9"

Maul löffelförmig
 jaws spoon-shaped



SAMII

250-064-192

230 mm / 9"

Maul löffelförmig
 jaws spoon-shaped



SAMII

250-064-195

230 mm / 9"

Maul löffelförmig
 jaws spoon-shaped



SAMII

250-064-196

230 mm / 9"

Maul löffelförmig
 jaws spoon-shaped



SAMII

250-064-197





230 mm / 9"

Maul löffelförmig
 jaws spoon-shaped

alle Mikro-Pinzetten sind auch mit RZ-Diamond dust beschichteten Spitzen erhältlich
 all Micro Forceps holder are also available with RZ diamond dust coated tips

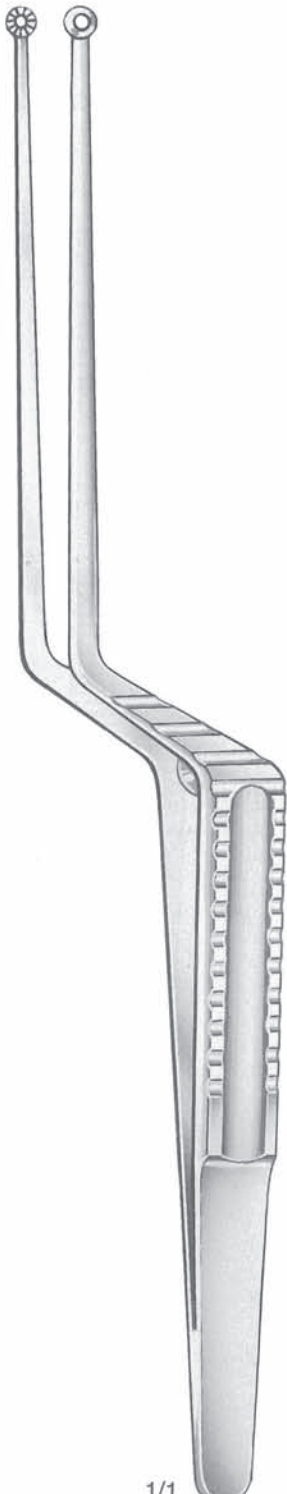
**Pinzetten zum Fassen von Gewebe, Tumoren
Forceps for grasping tissue, tumors**



Artikel-Nr. Cat. No.	Gesamtlänge Total length			
250-024-768	200 mm / 8"	YASARGIL	 Ø 3 mm	
250-024-766	200 mm / 8"	HUNT	 Ø 5 mm	
250-064-110	185 mm / 7 1/4"		 1/1 feine Spitzen fine tips	
250-064-111	185 mm / 7 1/4"		 1/1 breite Spitzen broad tips	
250-064-112	185 / 7 1/4"		 1/1 breite Spitzen broad tips	
			1/1	HUNT 250-024-766 200 mm 8"

alle Mikro-Pinzetten sind auch mit RZ-Diamond dust beschichteten Spitzen erhältlich
 all Micro Forceps holder are also available with RZ diamond dust coated tips



Pinzetten zum Fassen von Gewebe, Tumoren
Forceps for grasping tissue, tumors



1/1

HUNT
250-024-765
200 mm
8"



Ø 5 mm

Artikel-Nr.
Cat. No.

250-024-765

Gesamtlänge
Total length

200 mm / 8"

Maul flach, gezahnt
flat jaws, serrated



Artikel-Nr.
Cat. No.

Gesamtlänge
Total length

250-024-260

155 mm / 6"

LAZAR

Spitzen 0,5 mm
Tips 0,5 mm



250-024-261

155 mm / 6"

LAZAR

Spitzen 0,8 mm
Tips 0,8 mm



250-024-264

185 mm / 7 1/4"

Spitzen 0,5 mm
Tips 0,5 mm



1/1

LAZAR
250-024-261
155 mm
6"



Mikro-Knüpfpinzetten
Micro Suture Tying Forceps



1/1
VISE
 250-024-336
 135 mm
 5 1/4"



1/1

Artikel-Nr.
 Cat. No.

Gesamtlänge
 Total length

250-024-338

120 mm / 4 3/4"

Spitzen 0,3 mm
 Tips 0,3 mm

VISE

250-024-336

135 mm / 5 1/4"

Spitzen 0,3 mm
 Tips 0,3 mm



1/1



1/1

VISE

250-024-337

135 mm / 5 1/4"

Spitzen 0,3 mm
 Tips 0,3 mm



1/1
AUSTIN
 250-024-505
 95 mm
 3 3/4"



1/1

250-024-505

95 mm / 3 3/4"

Spitzen 0,2 mm, 1 x 2 Zähne
 Tips 0,2 mm, 1 x 2 teeth

AUSTIN

250-024-340

140 mm / 5 1/2"

Spitzen 0,8 mm
 Tips 0,8 mm

250-024-342

180 mm / 7"

Spitzen 0,8 mm
 Tips 0,8 mm



1/1

Atraumatische Pinzetten DE BAKEY
Atraumatic Tissue Forceps DE BAKEY



Artikel-Nr.
Cat. No.

Gesamtlänge
Total length

290-550-160 160 mm / 6¼"
 290-550-200 200 mm / 8"
 290-550-240 240 mm / 9½"
 290-550-300 300 mm / 12"
 Spitzen 1,5 mm
 Tips 1,5 mm

DE BAKEY



1/1

290-551-160 160 mm / 6¼"
 290-551-200 200 mm / 8"
 290-551-240 240 mm / 9½"
 290-551-300 300 mm / 12"
 Spitzen 1,5 mm
 Tips 1,5 mm

DE BAKEY

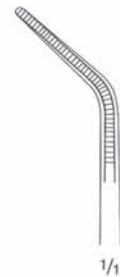

1/1

290-552-160 160 mm / 6¼"
 290-552-200 200 mm / 8"
 290-552-240 240 mm / 9½"
 290-552-300 300 mm / 12"
 Spitzen 2,0 mm
 Tips 2,0 mm

DE BAKEY



1/1

290-553-160 160 mm / 6¼"
 290-553-200 200 mm / 8"
 290-553-240 240 mm / 9½"
 290-553-300 300 mm / 12"
 Spitzen 2,0 mm
 Tips 2,0 mm

DE BAKEY

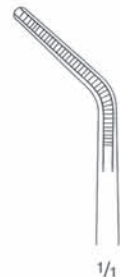

1/1

290-557-160 160 mm / 6¼"
 290-557-200 200 mm / 8"
 290-557-240 240 mm / 9½"
 290-557-300 300 mm / 12"
 Spitzen 2,4 mm
 Tips 2,4 mm

DE BAKEY



1/1



1/1

DE BAKEY
290-552-160
 160 mm
 6 ¼"

Weitere atraumatische Pinzetten auf Anfrage
 Other Atraumatic Tissue Forceps on request



Atraumatische Pinzetten DE BAKEY
Atraumatic Tissue Forceps DE BAKEY



290-548-200
 200 mm
 8"



1/1

DE BAKEY

Artikel-Nr. Cat. No.	Gesamtlänge Total length
290-548-160	160 mm / 6¼"
290-548-200	200 mm / 8"
290-548-240	240 mm / 9½"
290-548-300	300 mm / 12"
	Spitzen 2,8 mm Tips 2,8 mm



1/1

DE BAKEY

290-558-160	160 mm / 6¼"
290-558-200	200 mm / 8"
290-558-240	240 mm / 9½"
290-558-300	300 mm / 12"
	Spitzen 2,8 mm Tips 2,8 mm



1/1

DE BAKEY

290-554-160	160 mm / 6¼"
290-554-200	200 mm / 8"
290-554-240	240 mm / 9½"
290-554-300	300 mm / 12"
	Spitzen 3,5 mm Tips 3,5 mm



1/1

DE BAKEY

290-555-160	160 mm / 6¼"
290-555-200	200 mm / 8"
290-555-240	240 mm / 9½"
290-555-300	300 mm / 12"
	Spitzen 3,5 mm Tips 3,5 mm

Weitere atraumatische Pinzetten auf Anfrage
 Other Atraumatic Tissue Forceps on request



Artikel-Nr. Cat. No.	Gesamtlänge Total length
250-022-046	135 mm / 5½"



1/1

250-022-048	155 mm / 6"
-------------	-------------



1/1

250-022-052	180 mm / 7"
-------------	-------------

CASPAR



1/1

250-022-054	200 mm / 8"
-------------	-------------



1/1



1/1

Weitere Skalpellgriffe und-Klingen auf Anfrage
Other Scalpel Handles and Blades on request

250-022-054
200 mm
8"



Skalpellgriffe Scalpel Handles

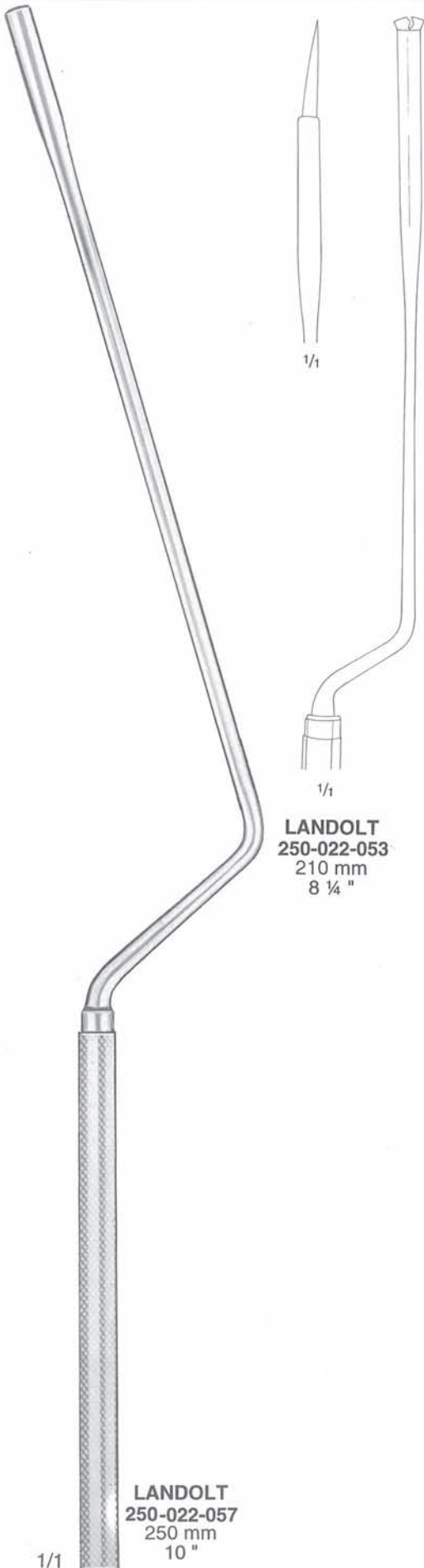

LANDOLT
250-022-053
210 mm
8 1/4 "

LANDOLT
250-022-057
250 mm
10 "

LANDOLT

Artikel-Nr.
Cat. No.

Gesamtlänge
Total length

250-022-053

210 mm / 8 1/4"

250-022-057

250 mm / 10"

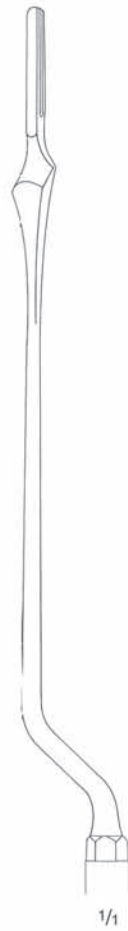

250-022-071
210 mm
8 1/4 "

Weitere Skalpellgriffe und-Klingen auf Anfrage
Other Scalpel Handles and Blades on request

Explorations- und Koagulationshäkchen
 Exploration- and Coagulation Hooks



Artikel-Nr.
 Cat. No.

Gesamtlänge
 Total length

250-020-088

245 mm / 9 3/4"

CASPAR

isoliert
 insulated

250-010-088

245 mm / 9 3/4"

nicht isoliert
 not insulated



250-020-089

245 mm / 9 3/4"

CASPAR

isoliert
 insulated

250-010-089

245 mm / 9 3/4"

nicht isoliert
 not insulated



250-020-090

245 mm / 9 3/4"

CASPAR

isoliert
 insulated

250-010-090

245 mm / 9 3/4"

nicht isoliert
 not insulated



250-020-091

245 mm / 9 3/4"

CASPAR

isoliert
 insulated

250-010-091

245 mm / 9 3/4"

nicht isoliert
 not insulated



CASPAR
 250-010-088
 245 mm
 9 3/4"

1/1



Nervwurzelhaken
Nerve Root Retractor



1/1

LOVE
250-694-190
190 mm
7 1/2"

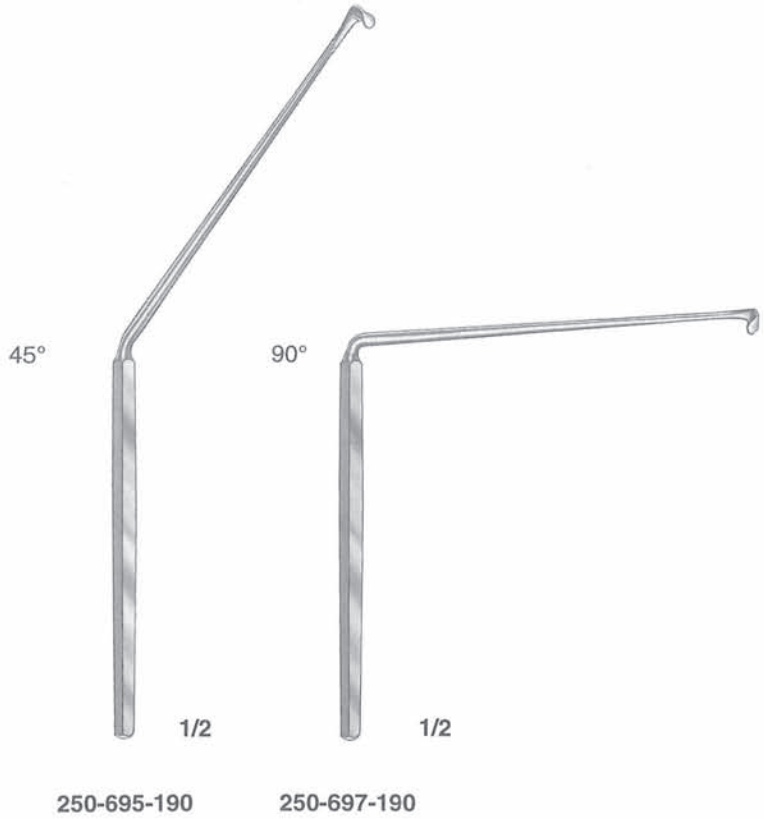

Artikel-Nr.
Cat.No.

Gesamtlänge
Total length

250-694-190

190 mm / 7 1/2"
gerade/straight

250-695-190

190 mm / 7 1/2"
45°

250-697-190

190 mm / 7 1/2"
90°



Artikel-Nr. Cat. No.	Gesamtlänge Total length
250-064-270	185 mm / 7 1/4"
250-064-271	185 mm / 7 1/4"
250-064-272	185 mm / 7 1/4"
250-064-273	185 mm / 7 1/4"

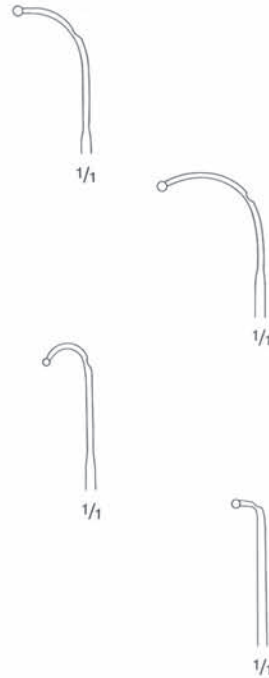

YASARGIL

Fadenführer geknöpft
Ligature Guides, probe pointed

250-064-396	185 mm / 7 1/4"
250-064-397	185 mm / 7 1/4"
250-064-398	185 mm / 7 1/4"
250-064-399	185 mm / 7 1/4"

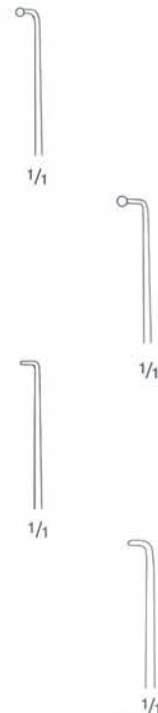







1/1
KRAYENBÜHL
250-064-396
185 mm
7 1/4"

KRAYENBÜHL

Nerv- und Gefäßhäkchen
Nerve- and Vessel Hooks

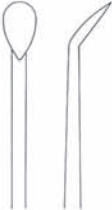

Mikro-Raspatorien
Micro Raspatories

	Artikel-Nr. Cat. No.	Gesamtlänge Total length
 1/1 YASARGIL 250-064-301 185 mm 7 1/4"	 1/1 YASARGIL	250-064-301 185 mm / 7 1/4"
	 1/1 YASARGIL	250-064-303 185 mm / 7 1/4"
	 1/1 YASARGIL	250-064-304 185 mm / 7 1/4"
	 1/1 YASARGIL	250-064-305 185 mm / 7 1/4"
	 1/1	250-064-337 230 mm / 9" plattenförmig round blade
	 1/1	250-064-338 230 mm / 9" plattenförmig round blade



Artikel-Nr.
Cat. No.

Gesamtlänge
Total length

250-064-346

230 mm / 9"



250-064-320

185 mm / 7 1/4"

YASARGIL



250-064-321

185 mm / 7 1/4"

YASARGIL



250-064-322

185 mm / 7 1/4"

YASARGIL

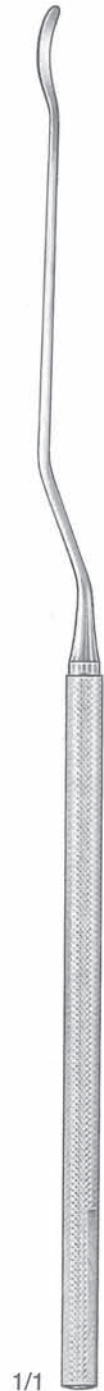
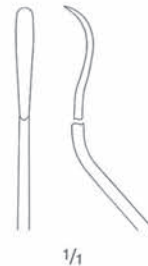

1/1
YASARGIL
250-064-321
185 mm
7 1/4"



Mikro-Löffel
Micro Scoops



1/1

250-064-336
230 mm
9"



1/1

Artikel-Nr.
Cat. No.

Gesamtlänge
Total length

250-064-335

230 mm / 9"

scharf
sharp



1/1

250-064-336

230 mm / 9"

scharf
sharp

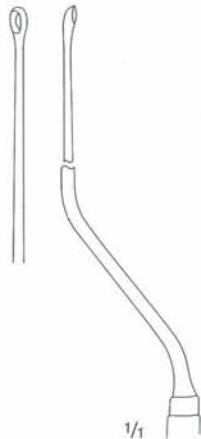

1/1

YASARGIL

250-064-325

185 mm / 7 1/4"

scharf
sharp



Artikel-Nr.
 Cat.No.

Gesamtlänge
 Total length

250-064-362

95 mm / 3 3/4"

JACOBSON

auswechselbares
 Gefäßmesser für
 Griff 250-064-361

interchangeable
 Vessel Knife for
 handle 250-064-361



250-064-363

85 mm / 3 3/8"

auswechselbares
 Haken für
 Griff 250-064-361

interchangeable
 Hook for handle
 250-064-361



1/1

250-064-361
 105 mm
 4 1/8"

Griff mit Spannutter
 Handle with chuck



Mikro-Häkchen, Mikro-Gefäßmesser
Micro Hooks, Micro Vessel Knives



1/1
250-064-331
230 mm
9"



Artikel-Nr.
Cat. No.

250-064-330

Gesamtlänge
Total length

230 mm / 9"

scharf
sharp



250-064-331

230 mm / 9"

stumpf
blunt



250-064-375

185 mm / 7 1/4"

scharf, gebogen
sharp, curved



FISCH

250-064-376

185 mm / 7 1/4"

scharf, abgewinkelt
sharp, angled

JACOBSON









250-064-350

185 mm / 7 1/4"

Mikro-Gefäßmesser
Micro Vessel Knife





Artikel-Nr. Cat. No.	Gesamtlänge Total length			
250-064-351	185 mm / 7 1/4"	KOOS		
250-064-352	185 mm / 7 1/4"	KOOS		
250-064-353	185 mm / 7 1/4"	KOOS		
250-064-354	185 mm / 7 1/4"	KOOS		
250-064-356	185 mm / 7 1/4"	KOOS		
250-064-357	185 mm / 7 1/4"	KOOS		
250-064-365	185 mm / 7 1/4"	YASARGIL		
250-064-366	185 mm / 7 1/4"	YASARGIL		

1/1

KOOS
250-064-352
185 mm
7 1/4"



**Tumormesser
Knives for tumor tissue**

		Artikel-Nr. Cat. No.	Gesamtlänge Total length
<p>1/1</p> <p>SAMII 250-064-405 200 mm 8"</p>	<p>1,0 mm</p>	<p>SAMII</p> <p>250-064-400</p> <p>250-064-410</p>	<p>200 mm / 8"</p> <p>230 mm / 9"</p>
	<p>1,5 mm</p>	<p>SAMII</p> <p>250-064-401</p> <p>250-064-411</p>	<p>200 mm / 8"</p> <p>230 mm / 9"</p>
	<p>2,0 mm</p>	<p>SAMII</p> <p>250-064-402</p> <p>250-064-412</p>	<p>200 mm / 8"</p> <p>230 mm / 9"</p>
	<p>2,5 mm</p>	<p>SAMII</p> <p>250-064-403</p> <p>250-064-413</p>	<p>200 mm / 8"</p> <p>230 mm / 9"</p>
	<p>3,0 mm</p>	<p>SAMII</p> <p>250-064-404</p> <p>250-064-414</p>	<p>200 mm / 8"</p> <p>230 mm / 9"</p>
	<p>3,5 mm</p>	<p>SAMII</p> <p>250-064-405</p> <p>250-064-415</p>	<p>200 mm / 8"</p> <p>230 mm / 9"</p>
	<p>4,0 mm</p>	<p>SAMII</p> <p>250-064-406</p> <p>250-064-416</p>	<p>200 mm / 8"</p> <p>230 mm / 9"</p>
	<p>5,0 mm</p>	<p>SAMII</p> <p>250-064-408</p> <p>250-064-418</p>	<p>200 mm / 8"</p> <p>230 mm / 9"</p>

Tumormesser
Knives for tumor tissue



Artikel-Nr. Cat. No.	Gesamtlänge Total length		
250-064-851	200 mm / 8"	SAMII	<p>ø 1,5 mm</p>
250-064-861	230 mm / 9"		
250-064-854	200 mm / 8"	SAMII	<p>ø 3,0 mm</p>
250-064-864	230 mm / 9"		
250-064-856	200 mm / 8"	SAMII	<p>ø 4,5 mm</p>
250-064-866	230 mm / 9"		
250-064-858	200 mm / 8"	SAMII	<p>ø 6,0 mm</p>
250-064-868	230 mm / 9"		
250-064-298	230 mm / 9"	SAMII	<p>1,8 mm</p>
250-064-299	230 mm / 9" Lanzettenmesser Lancet knives	SAMII	<p>2,5 mm</p>
			<p>1/1 SAMII 250-064-864 230 mm 9"</p>



Mikro-Dissektoren
Micro Dissectors



1/1

CASPAR
250-066-303
230 mm
9"

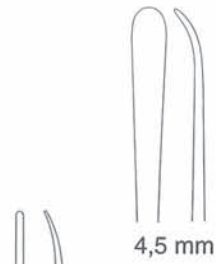

4,5 mm



1 mm



1/1



1/1



1/1



3 mm



3 mm



1/1

CASPAR

Artikel-Nr.
Cat. No.

250-066-303

Gesamtlänge
Total length

230 mm / 9"

CASPAR

250-066-310

200 mm / 8"

250-064-332

230 mm / 9"

250-064-333

230 mm / 9"

250-064-334

230 mm / 9"

250-062-150

185 mm / 7 1/4"

250-062-151







215 mm / 8 1/2"

YASARGIL

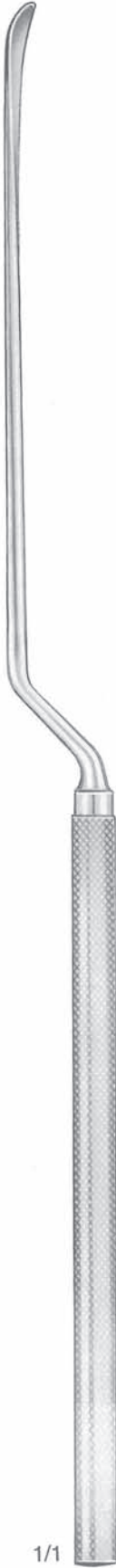
250-064-302

185 mm / 7 1/4"



Artikel-Nr. Cat. No.	Gesamtlänge Total length			
250-066-305	230 mm / 9"	CASPAR		 <p>1/1</p> <p>CASPAR 250-066-305 230 mm 9"</p>
250-066-307	230 mm / 9"	CASPAR		
250-066-311	210 mm / 8 1/4"	CASPAR		
250-066-312	210 mm / 8 1/4"	CASPAR		
250-064-343	230 mm / 9"			
250-064-344	230 mm / 9"			



Dissektoren
Dissectors

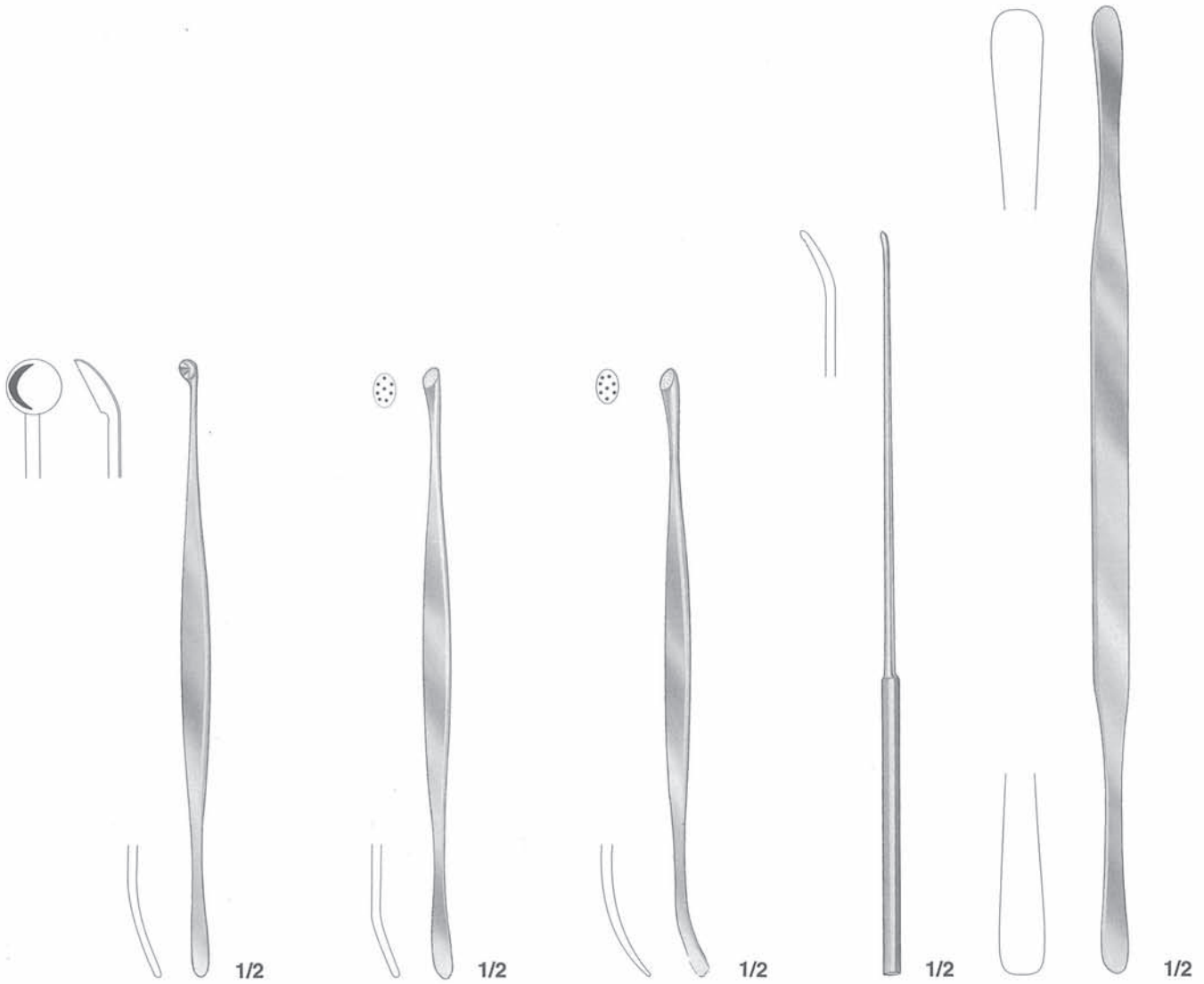

Penfield Fig. 1
doppelendig
double ended

250-691-175
175 mm
7 "

Penfield Fig. 2
doppelendig
double ended

250-692-195
195 mm
7³/₄ "

Penfield Fig. 3
doppelendig
double ended

250-693-195
195 mm
7³/₄ "

Penfield Fig. 4
einendig
single ended

250-694-215
215 mm
8¹/₂ "

Penfield Fig. 5
doppelendig
double ended

250-695-290
290 mm
11¹/₂ "



Artikel-Nr.
Cat. No.

Gesamtlänge
Total length

250-064-315

185 mm / 7¼"

JACOBSON



250-066-309

230 mm / 9"

CASPAR



1/1

CASPAR
250-066-309
230 mm
9"

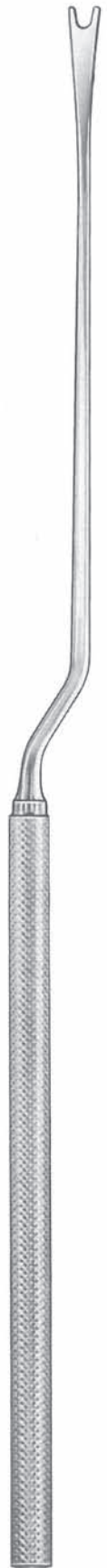



Tumorgabeln
Tumor Forks



1/1

OKONEK-YASARGIL
250-064-380
230 mm
9"



3 mm

Artikel-Nr.
Cat. No.

Gesamtlänge
Total length

250-064-380

230 mm / 9"



4 mm

250-064-381

230 mm / 9"

**OKONEK-
YASARGIL**



5 mm

250-064-382

230 mm / 9"



8 mm

250-064-384

230 mm / 9"



Artikel-Nr.
Cat. No.

250-064-392

Gesamtlänge
Total length

185 mm / 7 1/4"

mit Schutzkappe
with guard

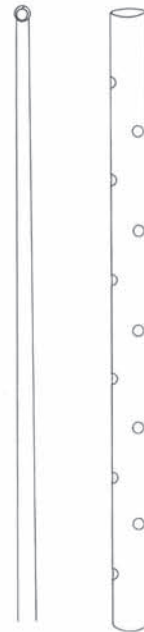

1/1

ø 1,8 mm









1/1

250-064-392
185 mm
7 1/4"



Gefäßspreizer, Gefäßdilatoren, Knopfsonden
 Vessel Spreader, Vessel Dilators, Vessel Probes

				Artikel-Nr. Cat. No.	Gesamtlänge Total length
		BIEMER		250-064-310	160 mm / 6 1/4" Gefäßspreizer Vessel Spreader
				250-064-306	125 mm / 5" Gefäßdilator Vessel Dilator
				250-064-307	125 mm / 5" Gefäßdilator Vessel Dilator
				250-064-308	125 mm / 5" Gefäßdilator Vessel Dilator
		JACOBSON		250-064-311	185 mm / 7 1/4" Knopfsonde Probe with ball tip
		JACOBSON		250-064-312	185 mm / 7 1/4" Doppelsonde Vessel Probe

BIEMER
 250-064-310
 160 mm
 6 1/4"

YASARGIL-Aneurysmen-Gefäß-Clips
YASARGIL-Aneurysm-Vessel-Clips



YASARGIL-Standard
 aus hochwertigem Implantat-Stahl, antimagnetisch

für permanenten Verschluss

YASARGIL-Standard
 in high quality Implant-steel, antimagnetic

for permanent closure

Cat. No.	250-065-740	250-065-750	250-065-760	250-065-780	250-065-792	250-065-790
Form						
max. opening	6,2 mm	7,0 mm	7,8 mm	9,2 mm	10,6 mm	11,4 mm
Force	150 gms	180 gms	180 gms	200 gms	200 gms	200 gms

250-065-840	250-065-742	250-065-752	250-065-762	250-065-782	250-065-744	250-065-754
13,3 mm	6,0 mm	6,8 mm	7,5 mm	8,7 mm	5,5 mm	6,1 mm
200 gms	150 gms	180 gms	180 gms	200 gms	150 gms	180 gms

250-065-764	250-065-784	250-065-823	250-065-824	250-065-825	250-065-748	250-065-758
6,5 mm	7,4 mm	5,4 mm	5,8 mm	6,2 mm	7,9 mm	8,7 mm
180 gms	200 gms	180 gms	180 gms	180 gms	200 gms	200 gms



YASARGIL-Aneurysmen-Gefäß-Clips
YASARGIL-Aneurysm-Vessel-Clips

YASARGIL-Standard

aus hochwertigem Implantat-Stahl, antimagnetisch

für permanenten Verschluss

YASARGIL-Standard

in high quality Implant-steel, antimagnetic

for permanent closure

Cat. No.	250-065-759	250-065-797	250-065-798	250-065-603	250-065-613	250-065-623
Form						
max. opening	10,2 mm	11,9 mm	13,0 mm	6,2 mm	6,5 mm	7,8 mm
Force	200 gms	180 gms	180 gms	200 gms	200 gms	200 gms

250-065-763	250-065-819	250-065-820	250-065-822	250-065-850	250-065-851	250-065-830
8,4 mm	5,6 mm	5,6 mm	5,6 mm	5,4 mm	5,6 mm	7,2 mm
200 gms	200 gms	200 gms	200 gms	200 gms	200 gms	200 gms

250-065-832	250-065-833	250-065-746	250-065-761	250-065-747		
7,2 mm	8,2 mm	5,7 mm	8,0 mm	7,0 mm		
200 gms	200 gms	200 gms	200 gms	200 gms		

YASARGIL-Aneurysmen-Gefäß-Clips
YASARGIL-Aneurysm-Vessel-Clips



YASARGIL-Standard
 aus hochwertigem Implantat-Stahl, antimagnetisch

für permanenten Verschluss

gefenestert - 3,5 mm

YASARGIL-Standard
 in high quality Implant-steel, antimagnetic

for permanent closure

fenestrated - 3,5 mm

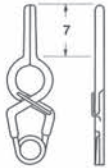
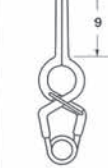
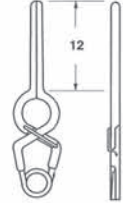
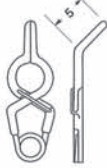
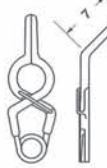
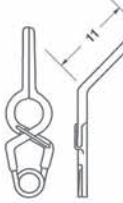
Cat. No.	250-065-600	250-065-610	250-065-620	250-065-602	250-065-612	250-065-622
Form						
max. opening	7,4 mm	8,4 mm	9,6 mm	5,8 mm	6,5 mm	7,2 mm
Force	150 gms	150 gms	180 gms	150 gms	150 gms	180 gms

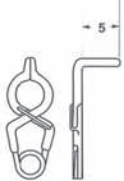
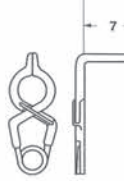
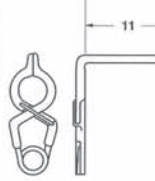
250-065-604	250-065-614	250-065-624				
						
4,9 mm	4,9 mm	4,9 mm				
150 gms	150 gms	180 gms				



YASARGIL-Aneurysmen-Gefäß-Clips
YASARGIL-Aneurysm-Vessel-Clips

YASARGIL-Standard
 aus hochwertigem Implantat-Stahl, antimagnetisch

für permanenten Verschuß

gefenestert - 5,0 mm

YASARGIL-Standard
 in high quality Implant-steel, antimagnetic

for permanent closure

fenestrated - 5,0 mm

Cat. No.	250-065-640	250-065-650	250-065-660	250-065-642	250-065-652	250-065-662
Form						
max. opening	7,9 mm	9,1 mm	10,3 mm	6,5 mm	7,2 mm	7,8 mm
Force	150 gms	150 gms	180 gms	150 gms	150 gms	180 gms

250-065-644	250-065-654	250-065-664	250-065-648	250-065-658	250-065-668	
5,5 mm	5,5 mm	5,5 mm	7,9 mm	8,8 mm	10,0 mm	
150 gms	150 gms	180 gms	150 gms	150 gms	180 gms	

YASARGIL-Aneurysmen-Gefäß-Clips
YASARGIL-Aneurysm-Vessel-Clips



YASARGIL-Standard
 aus hochwertigem Implantat-Stahl, antimagnetisch

für permanenten Verschuß

gefenestert - 5,0 mm

YASARGIL-Standard
 in high quality Implant-steel, antimagnetic

for permanent closure

fenestrated - 5,0 mm

Cat. No.	250-065-774	250-065-775	250-065-776	250-065-777	250-065-778	250-065-779
Form						
max. opening	5,8 mm	5,8 mm	5,8 mm	5,8 mm	5,8 mm	5,8 mm
Force	150 gms	150 gms	150 gms	150 gms	150 gms	150 gms

250-065-881	250-065-882	250-065-883	250-065-886	250-065-887	250-065-888	250-065-889
7,0 mm	7,8 mm	8,8 mm	5,8 mm	6,2 mm	5,8 mm	6,2 mm
150 gms	150 gms	150 gms	150 gms	150 gms	150 gms	150 gms

250-065-891	250-065-892	250-065-893	250-065-894			
5,6 mm	5,6 mm	5,6 mm	5,6 mm			
150 gms	150 gms	150 gms	150 gms			



YASARGIL-Aneurysmen-Gefäß-Clips
YASARGIL-Aneurysm-Vessel-Clips

YASARGIL-Standard temporär
 aus hochwertigem Implantat-Stahl, antimagnetisch

für temporären Verschuß

YASARGIL-Standard temporary
 in high quality Implant-steel, antimagnetic

for temporary closure

Cat. No.	250-065-751	250-065-753	250-065-755	250-065-781	250-065-783	250-065-785
Form						
max. opening	7,0 mm	6,8 mm	6,1 mm	9,2 mm	8,7 mm	7,4 mm
Force	70 gms	70 gms	70 gms	70 gms	70 gms	70 gms

250-065-756	250-065-791	250-065-793	250-065-795	250-065-801		
6,2 mm	11,4 mm	11,0 mm	9,9 mm	7,5 mm		
70 gms	90 gms	90 gms	90 gms	90 gms		

YASARGIL-Mini für temporären Verschuß
YASARGIL-Mini for temporary closure

Cat. No.	250-065-681	250-065-691	250-065-693	250-065-721	250-065-723	250-065-725
Form						
max. opening	3,3 mm	4,0 mm	3,8 mm	4,6 mm	4,4 mm	4,0 mm
Force	50 gms	50 gms	50 gms	70 gms	70 gms	70 gms

YASARGIL-Aneurysmen-Gefäß-Clips
YASARGIL-Aneurysm-Vessel-Clips



YASARGIL-Mini
 aus hochwertigem Implantat-Stahl, antimagnetisch

für permanenten Verschuß

YASARGIL-Mini
 in high quality Implant-steel, antimagnetic

for permanent closure

Cat. No.	250-065-680	250-065-690	250-065-700	250-065-710	250-065-720	250-065-682
Form						
max. opening	3,3 mm	4,0 mm	3,3 mm	4,0 mm	4,6 mm	3,2 mm
Force	110 gms	110 gms	110 gms	110 gms	110 gms	110 gms

250-065-692	250-065-711	250-065-712	250-065-713	250-065-726	250-065-722	250-065-694
3,8 mm	3,6 mm	3,8 mm	3,6 mm	4,0 mm	4,4 mm	3,6 mm
110 gms	110 gms	110 gms	110 gms	110 gms	110 gms	110 gms

250-065-714	250-065-724	250-065-716	250-065-717	250-065-727	250-065-728	250-065-806
3,5 mm	4,0 mm	3,5 mm	6,0 mm	7,0 mm	5,7 mm	4,5 mm
110 gms	110 gms	130 gms	130 gms	130 gms	130 gms	130 gms



YASARGIL-Aneurysmen-Gefäß-Clips
YASARGIL-Aneurysm-Vessel-Clips



1/2
YASARGIL
250-065-558
 180 mm
 7"



1/2
YASARGIL
250-065-552
 210 mm
 8 1/4"



1/2
250-065-607
 90 mm
 3 1/2"

Artikel-Nr.
 Cat.No.

Gesamtlänge
 Total length

für **Standard-Clips**
 for **Standard-Clips**

250-065-558	180 mm / 7"
--------------------	--------------------

für **Mini-Clips**
 for **Mini-Clips**

250-065-548	180 mm / 7"
--------------------	--------------------

für Anlegezange **Mini-Clips-FLEXIBEL-**
 for Applying forceps **Mini-Clips-FLEXIBLE-**

nicht drehbar
 not rotating

drehbar
 rotating

250-065-900	250-065-903	70 mm / 2 3/4"
250-065-901	250-065-904	90 mm / 3 1/2"
250-065-902	250-065-905	110 mm / 4 1/3"

für Anlegezange **Standard-Clips-FLEXIBEL-**
 for Applying forceps **Standard-Clips-FLEXIBLE-**

nicht drehbar
 not rotating

drehbar
 rotating

250-065-906	250-065-909	70 mm / 2 3/4"
250-065-907	250-065-910	90 mm / 3 1/2"
250-065-908	250-065-911	110 mm / 4 1/3"

für **Standard-Clips**
 for **Standard-Clips**

250-065-550	170 mm / 6 3/4"
250-065-552	210 mm / 8 1/4"
250-065-554	230 mm / 9"

für **Mini-Clips**
 for **Mini-Clips**

250-065-540	170 mm / 6 3/4"
250-065-542	210 mm / 8 1/4"
250-065-544	230 mm / 9"



Artikel-Nr. Cat.No.	Maulöffnung Opening	Maullänge Length of jaws	Schließkraft Closing force
250-064-560	4,0 mm	6 mm	30-40 g
250-064-561	5,0 mm	9 mm	30-40 g
250-064-562	5,0 mm	9 mm	20-25 g



2/1

BIEMER
250-064-560
Gefäßclip
Vessel Clip



1/1

Artikel-Nr. Cat.No.	Gesamtlänge Total-length
------------------------	-----------------------------

250-064-568	145 mm / 5 3/4" ohne Schloß without lock
-------------	--

250-064-569	145 mm / 5 3/4" mit Schloß with lock
-------------	--



1/1

BIEMER
250-064-569
145 mm
5 3/4"
Anlegepinzette
Applying Forceps



**Gefäßclips
Vessel Clips**



1/1

MÜLLER
250-065-010
38 mm
1½"
atraumatischer Gefäßclip
atraumatic Vessel Clip

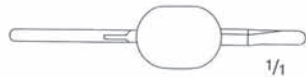

1/1

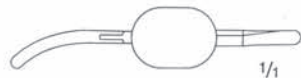

1/1

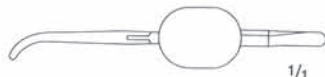

1/1

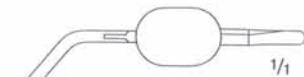

1/1

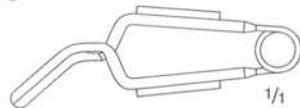

1/1



1/1

MÜLLER
250-065-005
38 mm
1½"

Artikel-Nr.
Cat.No.

Schließdruck
Closing Force

250-065-010

50 g

250-065-020

80 g

250-065-011

50 g

250-065-021

80 g

250-065-012

50 g

250-065-022

80 g

250-065-013

50 g

250-065-023

80 g

250-065-014

50 g

250-065-024

80 g

Fadenklemme
Maulteil fein
kariert

Ligature Forceps
jaw profile finely
cross-serrated



1/2

YASARGIL
250-064-519
180 mm
7"

Anlegepinzette für Gefäßclips
Applying Forceps for micro vessel clips



1/1

YASARGIL
250-064-517
32 mm
1½"

Mikro-Gefäß-Clip
Micro Vessel Clip

Artikel-Nr. Cat.No.		Gesamtlänge Total length		
140-216-035	Vena	35 mm / 1 1/2"		DE BAKEY 140-216-035 35 mm 1 1/8"
140-216-135	Arteria	35 mm / 1 1/2"		
140-216-040	Vena	40 mm / 1 3/4"		
140-216-140	Arteria	40 mm / 1 3/4"		
140-116-035	Vena	35 mm / 1 1/2" Titan, Titanium		DE BAKEY 140-216-035 35 mm 1 1/8"
140-116-135	Arteria	35 mm / 1 1/2" Titan, Titanium		
140-116-040	Vena	40 mm / 1 3/4" Titan, Titanium		
140-116-140	Arteria	40 mm / 1 3/4" Titan, Titanium		
140-217-035	Vena	35 mm / 1 1/2"		DE BAKEY 140-217-035 35 mm 1 1/2"
140-217-135	Arteria	35 mm / 1 1/2"		
140-217-040	Vena	40 mm / 1 3/4"		
140-217-140	Arteria	40 mm / 1 3/4"		
140-117-035	Vena	35 mm / 1 1/2" Titan, Titanium		DE BAKEY 140-217-035 35 mm 1 1/2"
140-117-135	Arteria	35 mm / 1 1/2" Titan, Titanium		
140-117-040	Vena	40 mm / 1 3/4" Titan, Titanium		
140-117-140	Arteria	40 mm / 1 3/4" Titan, Titanium		
140-218-035	Vena	35 mm / 1 1/2"		DE BAKEY 140-218-035 35 mm 1 1/2"
140-218-135	Arteria	35 mm / 1 1/2"		
140-218-040	Vena	40 mm / 1 3/4"		
140-218-140	Arteria	40 mm / 1 3/4"		
140-118-035	Vena	35 mm / 1 1/2" Titan, Titanium		DE BAKEY 140-218-035 35 mm 1 1/2"
140-118-135	Arteria	35 mm / 1 1/2" Titan, Titanium		
140-118-040	Vena	40 mm / 1 3/4" Titan, Titanium		
140-118-140	Arteria	40 mm / 1 3/4" Titan, Titanium		



Gefäßklemmen Vessel Clamps



DE BAKEY
140-011-050
50 mm
2"



DE BAKEY-Gefäßklemmen DE BAKEY Vessel Clamps

Artikel-Nr.
Cat.No.

Gesamtlänge
Total length

140-010-050

50 mm / 2"
atraumatisch, gerade
atraumatic, straight

140-011-050

50 mm / 2"
atraumatisch, gebogen
atraumatic, curved



GLOVER
140-132-060
50 mm
2"

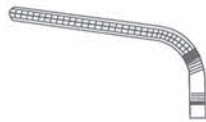

GLOVER-Gefäßklemme GLOVER Vessel Clamps

140-132-060

50 mm / 2"

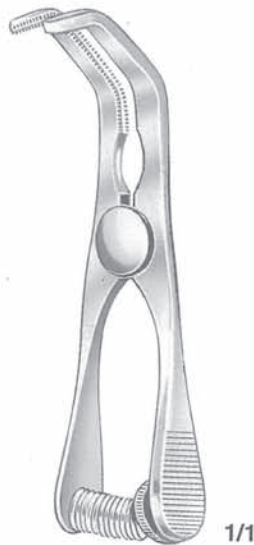

DE BAKEY-SATINSKY
140-133-060
70 mm
8 1/4"



DE BAKEY-SATINSKY- Gefäßklemme DE BAKEY-SATINSKY Vessel Clamps

140-133-060

70 mm / 8 1/4"

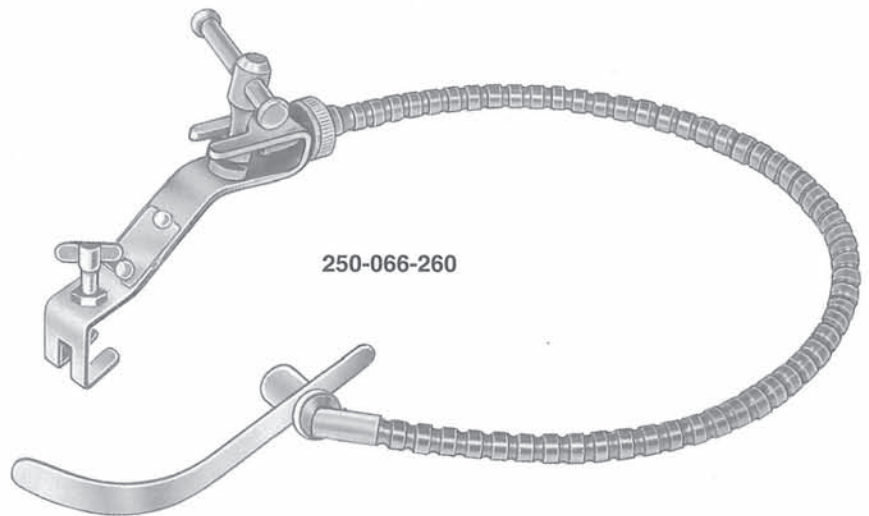

250-066-260 Hirnspatelhalter, selbsthaltend, flexibel, für flache Spatel, mit 1 Spannarm, komplett, bestehend aus:
250-066-267, 250-066-270, 250-066-271

Brain retractor, self retaining, flexible, for flat spatula, with 1 flexible arm, complete, consisting of:
250-066-267, 250-066-270, 250-066-271

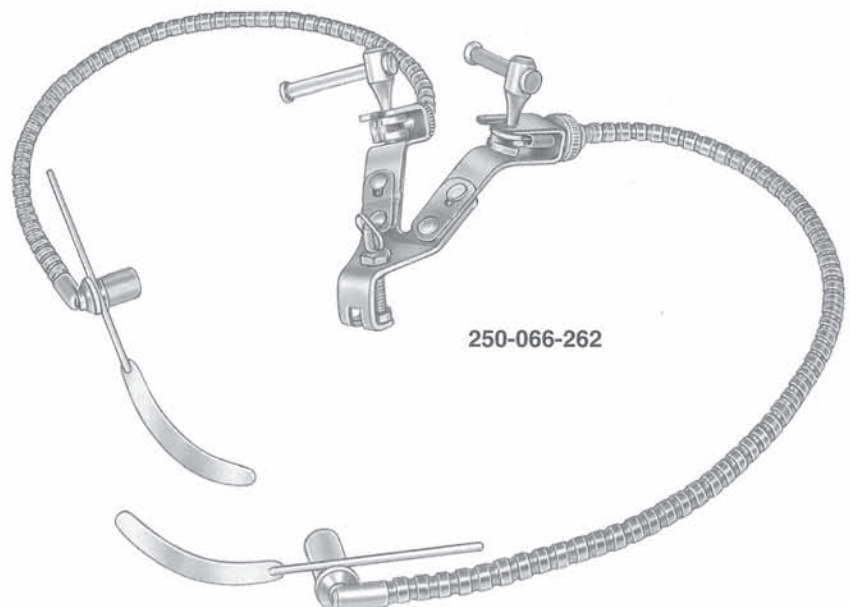

250-066-262 Hirnspatelhalter, selbsthaltend, flexibel, für runde und flache Spatel, mit 2 Spannarmen, komplett, bestehend aus:
250-066-270, 250-066-268, 250-066-271

Brain retractor, self retaining, flexible, for round and flat spatula, with 2 flexible arms, complete, consisting of:
250-066-270, 250-066-268, 250-066-271



YASARGIL Retraktor Set
YASARGIL Retractor Set

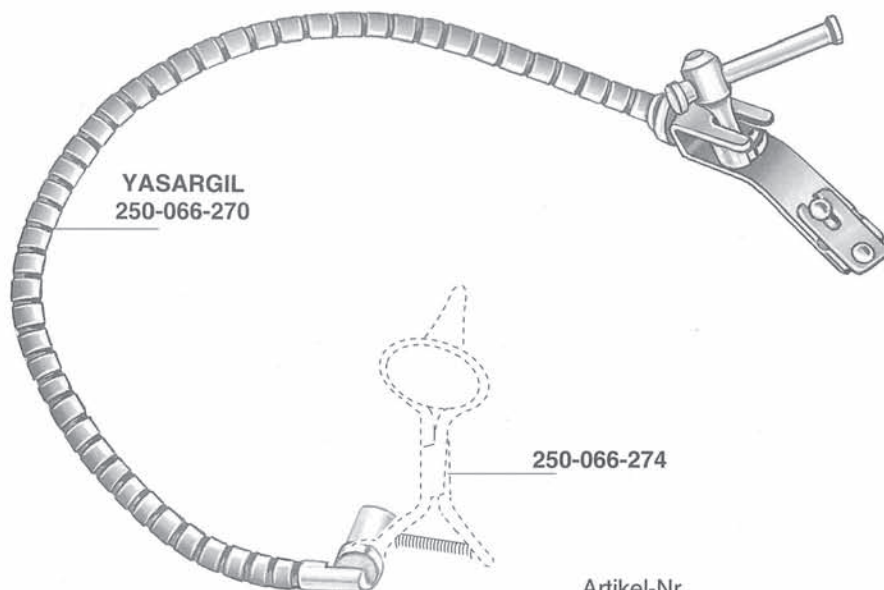

Artikel-Nr.
Cat.No.

250-066-270 Spannarm allein
Flexible arm only

250-066-274 Ohrtrichterhalter allein
Ear specula holder only

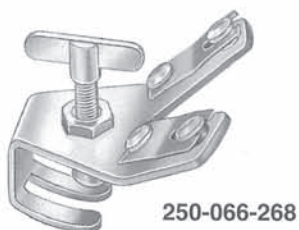

250-066-268 Fixiervorrichtung am Schädel für 2 Arme
Fixation for 2 arms at skull

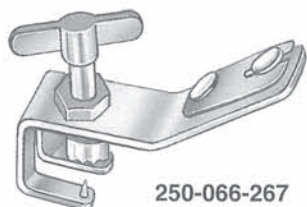

250-066-267 Fixiervorrichtung am Schädel für 1 Arm
Fixation for 1 arm at skull

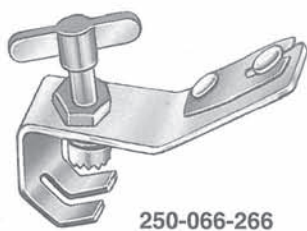

250-066-266 Fixiervorrichtung am Starrarm für 1 Arm
Fixation base for 1 arm at skull

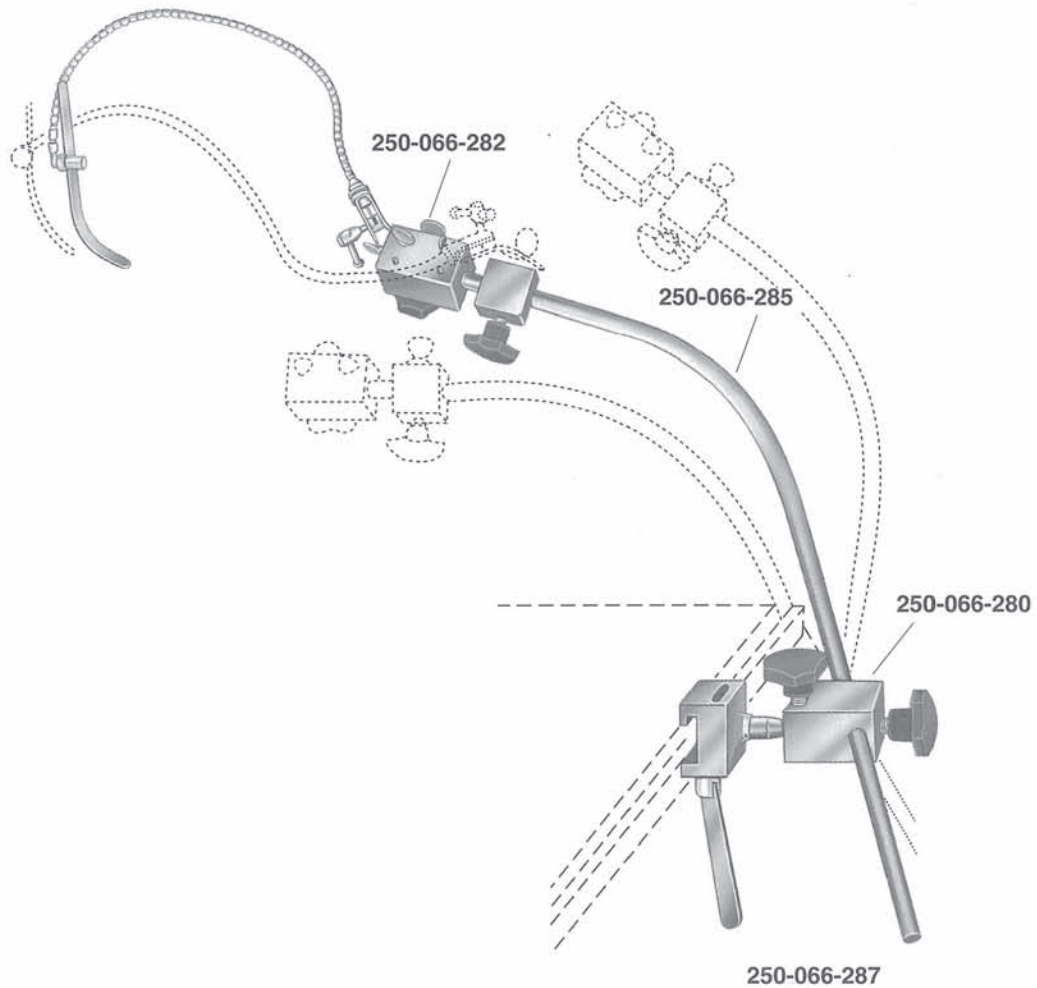

Artikel-Nr.
Cat.No.

250-066-280 Kugelgelenk Kloben
Ball and socket joint, articulated

250-066-285 Haltearm
Holding rod for fixation

250-066-282 Kupplungskopf für max. 5 Spannarme
Coupling head for 5 flexible arms max.

250-066-287 **YASARGIL Retractor Set 1 (1 Arm)**
zur Montage an Seitenschiene
best. aus: **250-066-280, 250-066-282,**
250-066-285, 250-066-270, 250-066-271

YASARGIL retractor set 1 (1 arm)
for fixation to OR table siderails,
consisting of: **250-066-280, 250-066-282,**
250-066-285, 250-066-270, 250-066-271



YASARGIL Retraktor Set
YASARGIL Retractor Set

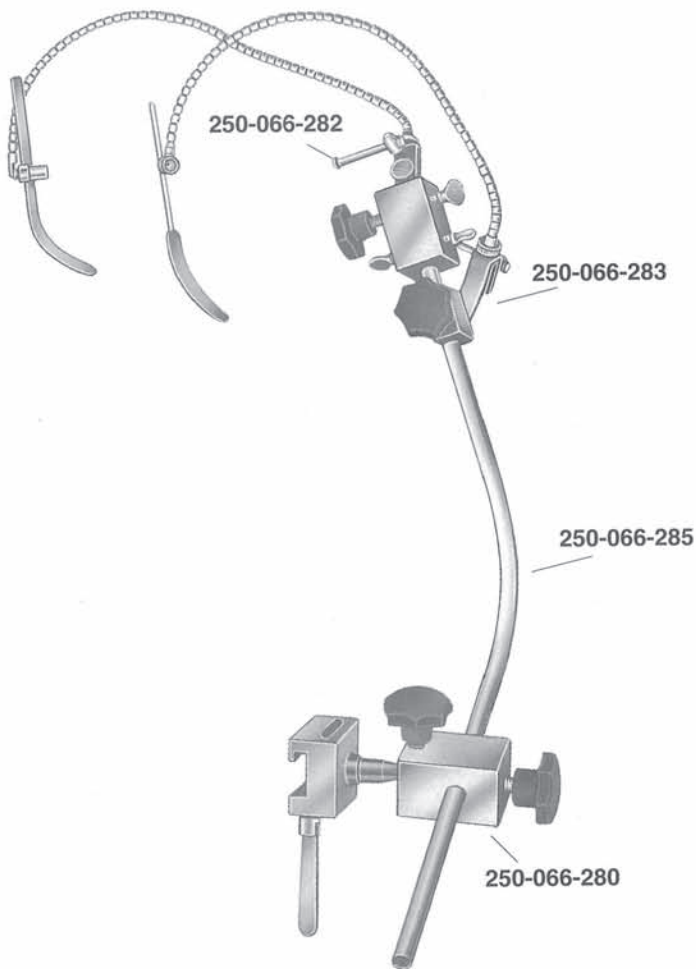

YASARGIL
250-066-288

- | | |
|-------------|--|
| 250-066-280 | Kugelenk Kloben
Ball and socket joint, articulated |
| 250-066-285 | Haltearm
Holding rod for fixation |
| 250-066-282 | Kupplungskopf für max. 5 Spannarme
Coupling head for 5 flexible arms max. |
| 250-066-283 | Kupplungskopf drehbar
Coupling head rotatable |
| 250-066-288 | YASARGIL Retractor Set 2 (2 Arme)
zur Montage an Seitenschienen
best. aus: 250-066-266, 250-066-270,
250-066-271 |
| | YASARGIL retractor set 2 (2 arms)
for fixation to OR table siderails,
consisting of: 250-066-266, 250-066-270,
250-066-271 |



Artikel-Nr.
Cat. No.

250-066-272 Halter für Hirnspatel mit rundem Schaft
Holder for brain spatula with round shaft



250-066-272

250-066-271 Halter für flache Hirnspatel
Holder for flat brain spatula

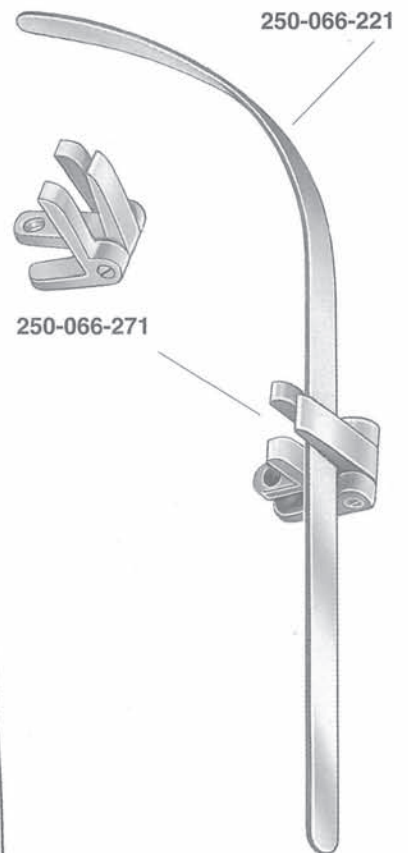

250-066-271

Hirnspatel, biegsam
Brain Spatulas, malleable

	Länge length	Breite width
250-066-220	200 mm	9 mm / 8"
250-066-221	200 mm	12 mm / 8"
250-066-222	250 mm	12 mm / 10"



250-066-221



Hirnspatel Brain Spatulas



1/1

250-066-233
200 mm
8"



1/1



1/2

250-066-258
155 mm
6"

HEIFETZ

Artikel-Nr. Cat.No.	Breite Width	Gesamtlänge Total length
250-066-231	14 mm	200 mm / 8"
250-066-232	17 mm	200 mm / 8"
250-066-233	20 mm	200 mm / 8"

biegsam
malleable

250-066-256	8 mm	155 mm / 6"
250-066-257	11 mm	155 mm / 6"
250-066-258	14 mm	155 mm / 6"
250-066-259	17 mm	155 mm / 6"

biegsam
malleable



CUSHING Hirnspatel
CUSHING Brain Spatulas

Artikel-Nr. Cat.No.	Gesamtlänge Total length	Breite Width
250-066-213	170 mm / 6 3/4"	8 x 10 mm
250-066-214	200 mm / 8"	13 x 15 mm
250-066-215	280 mm / 11"	16 x 18 mm



1/2

CUSHING
250-066-213
170 mm
6 3/4"



OLIVECRONA Hirnspatel, elastisch
OLIVECRONA Brain Spatulas, flexible

Artikel-Nr. Cat.No.	Gesamtlänge Total length	Breite Width
250-066-216	180 mm / 7"	7 + 9 mm
250-066-217	180 mm / 7"	11 + 13 mm
250-066-218	180 mm / 7"	15 + 18 mm
250-066-219	180 mm / 7"	18 + 22 mm



1/2

OLIVECRONA
250-066-216
180 mm
7"

YASARGIL Galeahaken
YASARGIL Galea Hooks

Artikel-Nr. Cat.No.	Feder Spring	Gesamtlänge Total length
250-066-020	ø 7 mm	310 mm / 12 1/4"
250-066-022	ø 9 mm	410 mm / 16"

1/2

YASARGIL
250-066-022
410 mm
16"



RANEY Anlege- und Abnehmezange für Kopfhautklammern
RANEY applying and removing forceps for scalp hemostasis clips

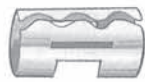

1/1

RANEY
250-066-001
16 cm
6 1/4"

250-066-001 **RANEY-Kopfhautklammer**
Packung à 10 Stck.
RANEY Scalp Haemostasis clip
package containing 10 clips





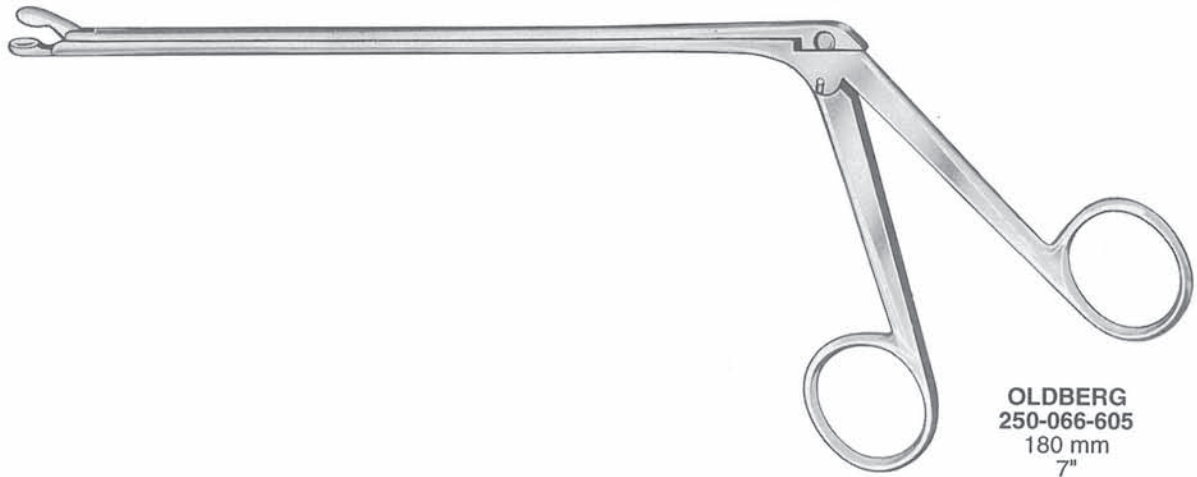

1/2

RANEY
250-066-003
16 cm
6 1/4"

250-066-003 **RANEY Clipanlege- und Abnehmezange**
für Kopfhautklammern, 16 cm
RANEY applying and removing forceps for
scalp hemostasis clips, 6 1/4"



OLDBERG
 250-066-605
 180 mm
 7"

Artikel-Nr. Cat.No.	Schaftlänge length of shaft		
250-066-605	180 mm / 7" Scharfe Hypophysenzange Sharp Pituitary Rongeur	OLDBERG	 ø 7 mm
250-066-599	190 mm / 7½" Scharfe Hypophysenzange Sharp Pituitary Rongeur	LANDOLT	 ø 2,2 mm
250-066-600	190 mm / 7½" Scharfe Hypophysenzange Sharp Pituitary Rongeur	YASARGIL	 ø 3,5 mm
250-066-345	200 mm / 8" Tumor-Faßzange, stumpf Tumor Grasping Forceps, blunt	LANDOLT	 ø 9 mm



Rongeurs
Rongeurs

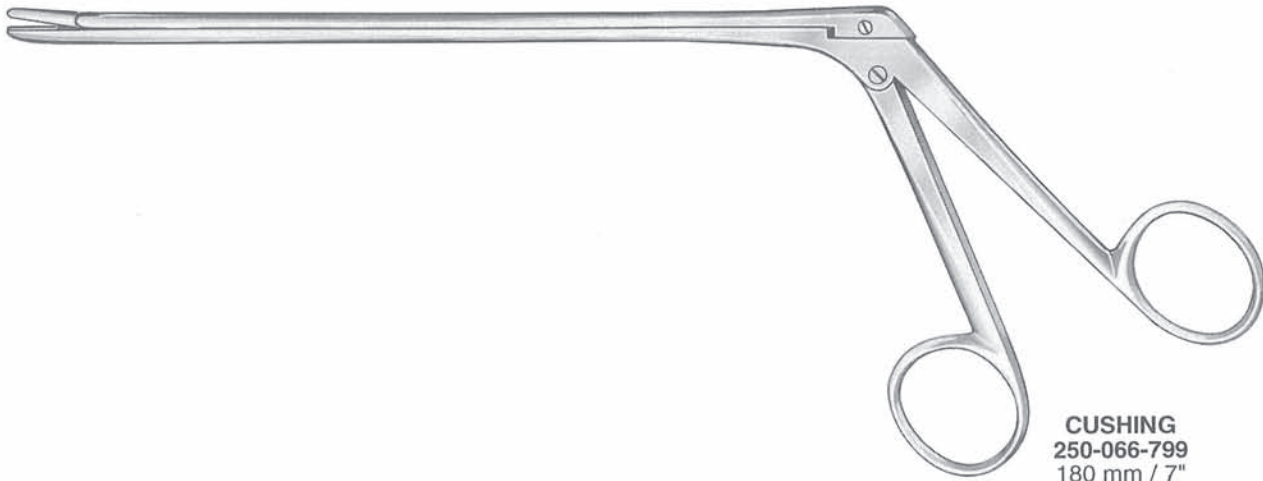

	Artikel-Nr. Cat.No.	Artikel-Nr. Cat.No.	Artikel-Nr. Cat.No.	Schaftlänge length of shaft
 CUSHING 2 x 10 mm	250-066-799	250-069-203	250-069-205	125 mm / 5"
	250-069-712	250-069-722	250-069-732	150 mm / 6"
	250-066-803	250-069-204	250-069-206	180 mm / 7"
 LOVE-GRUENWALD 3 x 10 mm	250-069-800	250-069-806	250-069-810	125 mm / 5"
	250-069-713	250-069-723	250-069-733	150 mm / 6"
	250-066-805	250-066-206	250-066-810	180 mm / 7"
 SPURLING 4 x 10 mm	250-069-801	250-069-814	250-069-811	125 mm / 5"
	250-069-714	250-069-724	250-069-734	150 mm / 6"
	250-066-807	250-066-814	250-066-811	180 mm / 7"

Weitere Rongeurs auf Anfrage
Other Rongeurs on request

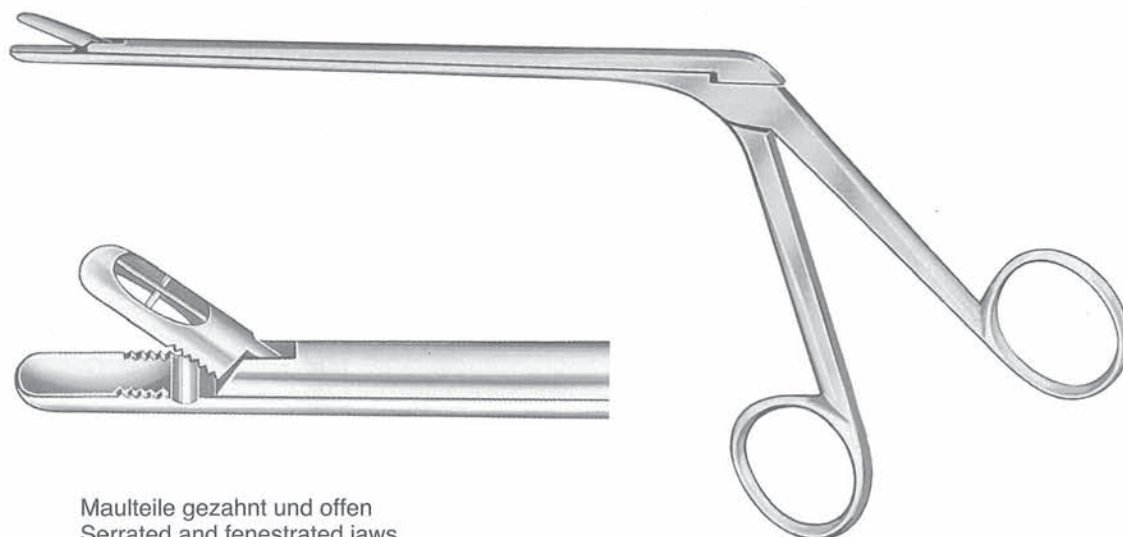

Maulteile gezahnt und offen
Serrated and fenestrated jaws

CASPAR
250-982-003
160 mm
6 1/4"

Maulbreite width of jaw	Schaftlänge length of shaft			
2 mm x 12 mm	140 mm / 5 1/2"	250-980-002	250-985-002	250-986-002
2 mm x 12 mm	160 mm / 6 1/4"	250-982-002	250-983-002	250-984-002
3 mm x 12 mm	140 mm / 5 1/2"	250-980-003	250-985-003	250-986-003
3 mm x 12 mm	160 mm / 6 1/4"	250-982-003	250-983-003	250-984-003
4 mm x 14 mm	140 mm / 5 1/2"	250-980-004	250-985-004	250-986-004
4 mm x 14 mm	160 mm / 6 1/4"	250-982-004	250-983-004	250-984-004
5 mm x 14 mm	140 mm / 5 1/2"	250-980-005	250-985-005	250-986-005
5 mm x 14 mm	160 mm / 6 1/4"	250-982-005	250-983-005	250-984-005
6 mm x 14 mm	140 mm / 5 1/2"	250-980-006	250-985-006	250-986-006
6 mm x 14 mm	160 mm / 6 1/4"	250-982-006	250-983-006	250-984-006



**Stanzen
Punches**

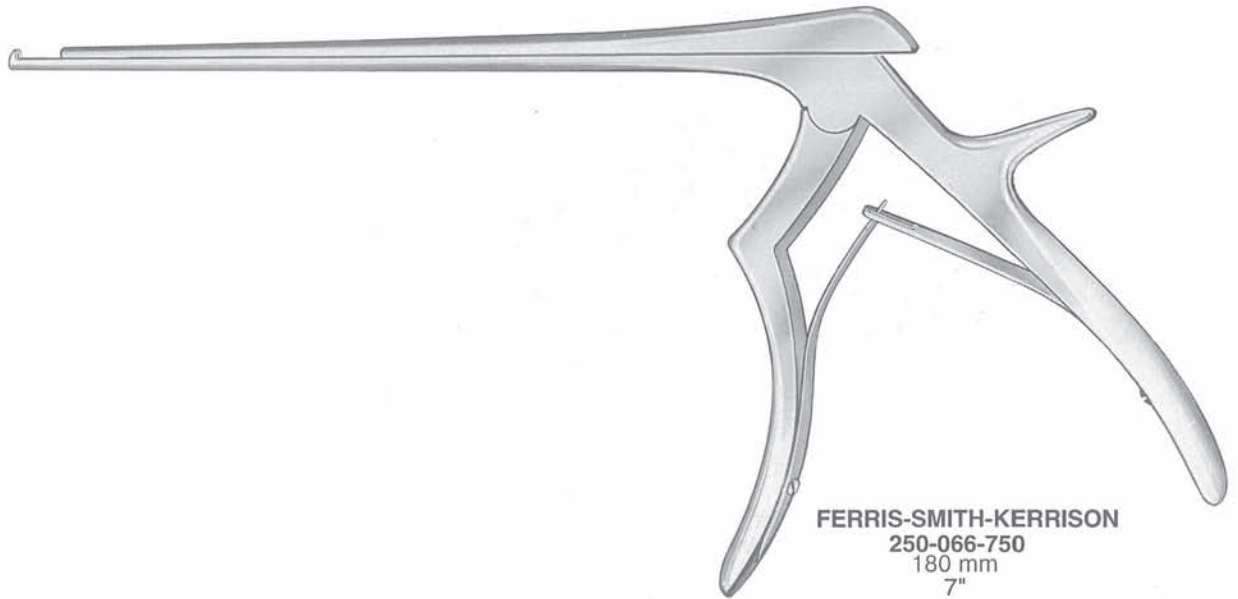

FERRIS-SMITH-KERRISON
250-066-750
180 mm
7"

	90°	90°	130°	130°	Schaftlänge length of shaft
1 mm					180 mm/ 7"
	Artikel-Nr. Cat.No.	Artikel-Nr. Cat.No.	Artikel-Nr. Cat.No.	Artikel-Nr. Cat.No.	
	250-066-716 KERRISON-JACOBY	250-069-201 FERRIS-SMITH-KERRISON	250-066-715 KERRISON-JACOBY	250-066-711 FERRIS-SMITH-KERRISON	
2 mm					180 mm/ 7"
	250-066-718 KERRISON-JACOBY	250-066-719 KERRISON-JACOBY	250-066-717 FERRIS-SMITH-KERRISON	250-066-712 FERRIS-SMITH-KERRISON	
3 mm					180 mm/ 7"
	250-066-750 FERRIS-SMITH-KERRISON	250-066-721 FERRIS-SMITH-KERRISON	250-066-720 FERRIS-SMITH-KERRISON	250-066-713 FERRIS-SMITH-KERRISON	
4 mm					180 mm/ 7"
	250-066-752 FERRIS-SMITH-KERRISON	250-069-202 FERRIS-SMITH-KERRISON	250-066-724 FERRIS-SMITH-KERRISON	250-066-714 FERRIS-SMITH-KERRISON	
5 mm					180 mm/ 7"
	250-066-754 FERRIS-SMITH-KERRISON	250-066-723 FERRIS-SMITH-KERRISON	250-066-722 FERRIS-SMITH-KERRISON	250-066-725 FERRIS-SMITH-KERRISON	

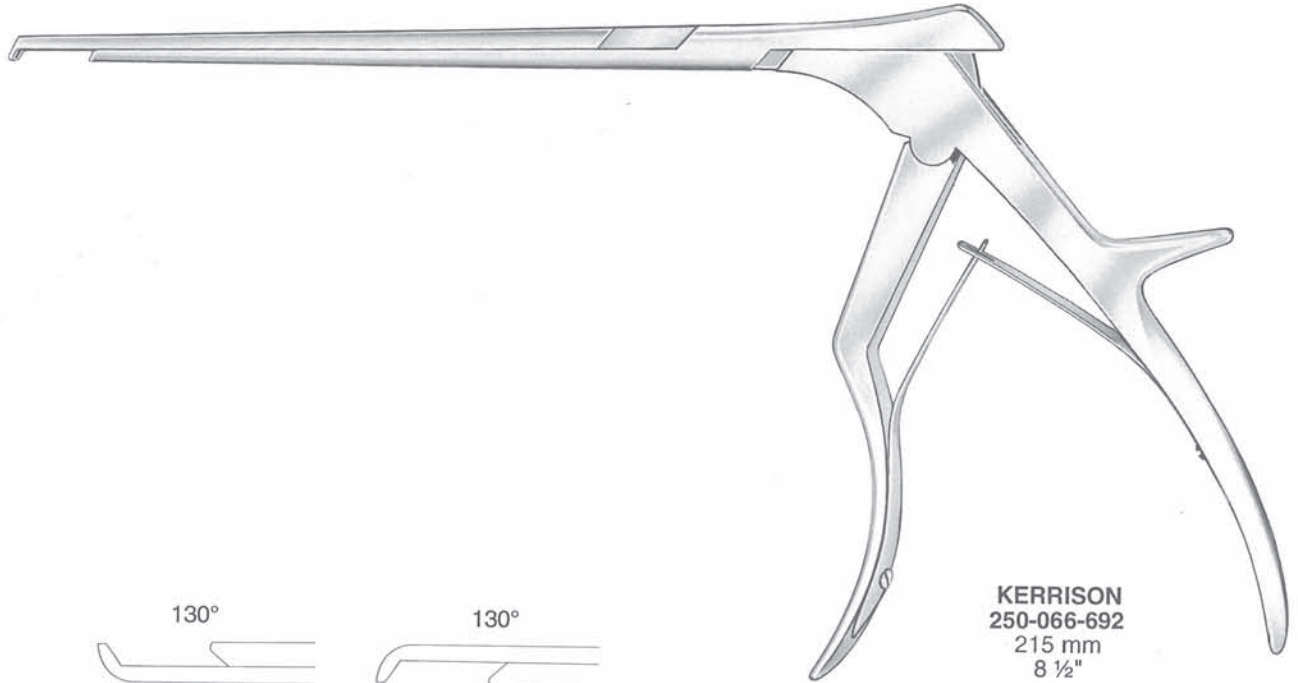

KERRISON
250-066-692
215 mm
8 1/2"

Artikel-Nr. Cat.No.	Artikel-Nr. Cat.No.	Schaftlänge Length of shaft	
250-066-682	250-066-692	215 mm / 8 1/2"	 2 mm
250-066-683	250-066-693	215 mm / 8 1/2"	 3 mm
250-066-684	250-066-694	215 mm / 8 1/2"	 4 mm
250-066-685	250-066-695	215 mm / 8 1/2"	 5 mm

Knochenstanzen mit dünner Fußplatte
Bone Punches with thin footplate

		250-066-771	250-066-781	175 mm / 7"	 1 mm
		250-066-772	250-066-782	175 mm / 7"	 2 mm
		250-066-773	250-066-783	175 mm / 7"	 3 mm

Weitere Stanzen auf Anfrage
Other Punches on request



Hypophysektomie-Instrumente
Pituitary Instruments



1/1

RAY
250-066-611
180 mm
7 1/8"



ø 4 mm

RAY

Artikel-Nr.
Cat. No.

250-066-611

Gesamtlänge
Total length

180 mm / 7 1/8"

Kürette, horizontal 45°
Curette, horizontal 45°



ø 4 mm

RAY

250-066-614

180 mm / 7 1/8"

Kürette, vertikal 45°
Curette, vertical 45°

Artikel-Nr. Cat. No.	Gesamtlänge Total length
250-066-616	215 mm / 8 1/4" Kürette, biegsam, nach rechts schneidend Curette, malleable, cutting to the right
250-066-617	215 mm / 8 1/4" Kürette, biegsam, nach links schneidend Curette, malleable, cutting to the left
250-066-618	215 mm / 8 1/4" Kürette, biegsam Curette, malleable
250-066-619	215 mm / 8 1/4" Raspatorium Raspatory

NICOLA



NICOLA



NICOLA



NICOLA

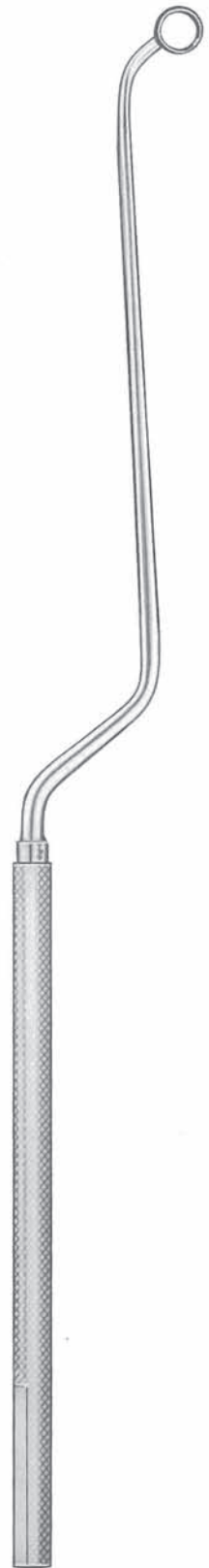

NICOLA
250-066-616
215 mm
8 1/4"



Hypophysektomie-Instrumente
Pituitary Instruments



HARDY
250-066-620
 245 mm
 9 3/4"



HARDY

Artikel-Nr.
 Cat.No.

Gesamtlänge
 Total length

250-066-620

links / left

245 mm / 9 3/4"

250-066-621

rechts / right

245 mm / 9 3/4"

Enucleator, stumpf
 Enucleator, blunt



HARDY

250-066-622

links / left

245 mm / 9 3/4"

250-066-623

rechts / right

245 mm / 9 3/4"

Enucleator, scharf
 Enucleator, sharp



HARDY

250-066-624

245 mm / 9 3/4"

Implantationsgabel
 Implant Fork



HARDY-FAHLBUSCH

250-066-608

245 mm / 9 3/4"

Dissektor, innen scharf
 Dissector, sharpened
 inner edge



HARDY-FAHLBUSCH

250-066-609

245 mm / 9 3/4"

Dissektor, innen scharf
 Dissector, sharpened
 inner edge



HARDY

250-066-631

260 mm / 10 1/4"

Kürette, biegsam
 Curette, malleable









HARDY

250-066-632

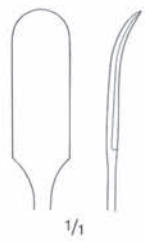
260 mm / 10 1/4"

Kürette, biegsam
 Curette, malleable

Artikel-Nr. Cat.No.		Gesamtlänge Total-length			
250-066-625	rechts/right	260 mm / 10 ³ / ₄ "	LANDOLT		
250-066-655	links/left	260 mm / 10 ³ / ₄ "			
		Eukleator, stumpf, biegsam Eucleator, blunt, malleable		1/1	
250-066-626	rechts/right	260 mm / 10 ³ / ₄ "	LANDOLT		
250-066-656	links/left	260 mm / 10 ³ / ₄ "			
		Eukleator, scharf, biegsam Eucleator, sharp, malleable		1/1	
250-066-627		260 mm / 10 ³ / ₄ "	LANDOLT		
		Kürette, biegsam Curette, malleable			
250-066-628		260 mm / 10 ³ / ₄ "	LANDOLT		
		Löffel, biegsam Scoop, malleable			
250-066-629		260 mm / 10 ³ / ₄ "	LANDOLT		
		Stumpfes Häkchen, biegsam Blunt Hook, malleable			
250-066-630		260 mm / 10 ³ / ₄ "	HOSOBUCHI		
		gabelförmige Spatel zur Darstellung des Hypophysenstiels, fest Fork Spatula, rigid			
				1/1	
					LANDOLT 250-066-625 260 mm 10 ³ / ₄ "



Hypophysektomie-Instrumente
Pituitary Instruments



FAHLBUSCH

Artikel-Nr.
Cat.No.

250-066-635

Gesamtlänge
Total-length

260 mm / 10 1/4"

Löffel, biegsam
Scoop, malleable



FAHLBUSCH

250-066-637

260 mm / 10 1/4"

Kürette, biegsam
Curette, malleable



LANDOLT-REULEN

250-066-640

260 mm / 10 1/4"

Raspatorium, fest
Raspatories, rigid



LANDOLT-REULEN

250-066-641

260 mm / 10 1/4"

Raspatorium, fest
Raspatories, rigid



LANDOLT-REULEN

250-066-642

260 mm / 10 1/4"

Kürette, fest
Curette, rigid



LANDOLT-REULEN

250-066-643

260 mm / 10 1/4"

Stumpfes Häkchen, fest
Blunt Hook, rigid

1,7 mm



LANDOLT-REULEN

250-066-644

260 mm / 10 1/4"

Dissektor, fest
Dissector, rigid

2,0 mm

FAHLBUSCH
250-066-635
260 mm
10 1/4"

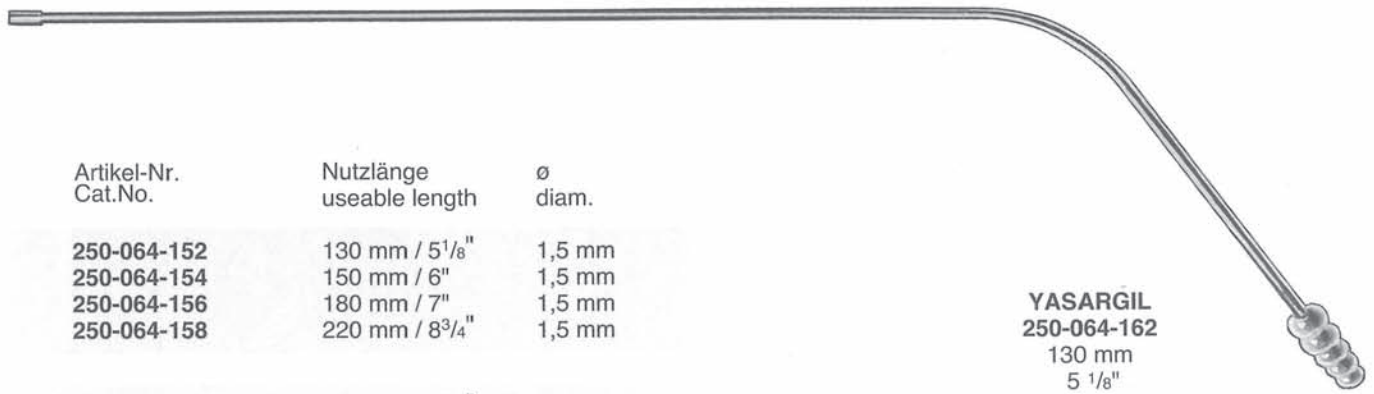
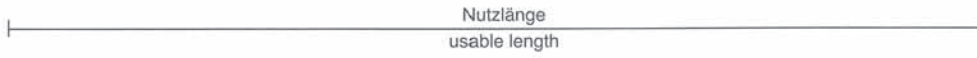

Artikel-Nr. Cat.No.	Nutzlänge useable length	∅ diam.
250-064-152	130 mm / 5 1/8"	1,5 mm
250-064-154	150 mm / 6"	1,5 mm
250-064-156	180 mm / 7"	1,5 mm
250-064-158	220 mm / 8 3/4"	1,5 mm
250-064-162	130 mm / 5 1/8"	2,0 mm
250-064-164	150 mm / 6"	2,0 mm
250-064-166	180 mm / 7"	2,0 mm
250-064-168	220 mm / 8 3/4"	2,0 mm
250-064-172	130 mm / 5 1/8"	2,5 mm
250-064-174	150 mm / 6"	2,5 mm
250-064-176	180 mm / 7"	2,5 mm
250-064-178	220 mm / 8 3/4"	2,5 mm
250-064-182	130 mm / 5 1/8"	3,5 mm
250-064-184	150 mm / 6"	3,5 mm
250-064-186	180 mm / 7"	3,5 mm
250-064-188	220 mm / 8 3/4"	3,5 mm
250-064-189	180 mm / 7"	4,5 mm

YASARGIL
250-064-162
130 mm
5 1/8"

mit LUER-Bohrung
with LUER boring



250-066-672
Spiegel
mirrors

6 mm
250-066-666

8 mm
250-066-668

10 mm
250-066-670

12 mm
250-066-672



250-066-674
Spiegelgriff
Mirror handle



1/2

CUSHING
250-150-100

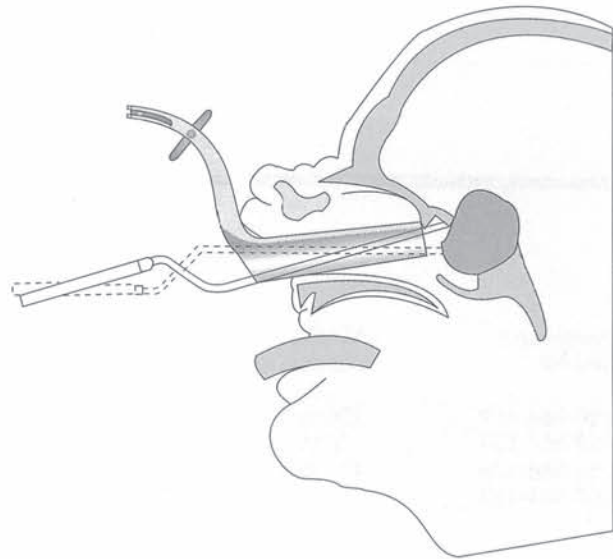

CUSHING-LANDOLT Spekula für trans-sphenoidale Hypophysektomie
CUSHING-LANDOLT Specula for trans-sphenoidal hypophysectomy

Artikel-Nr.
Cat.No.

Maße
size

250-150-100
250-150-101
250-150-102

70 x 15 mm
90 x 15 mm
110 x 15 mm



1/2

LANDOLT
250-150-210
210 mm
8¹/₄"

LANDOLT Spreizzange zum Spreizen der Spekula
LANDOLT Spreader for specula

Artikel-Nr.
Cat.No.

Länge
length

250-150-210

210 mm / 8¹/₄"

COTTLE Meißel
COTTLE Chisel

Artikel-Nr. Cat.No.	Breite width	Länge length
210-488-004	4 mm	185 mm, 7 ¹ / ₄ "
210-488-007	7 mm	185 mm, 7 ¹ / ₄ "
210-488-009	9 mm	185 mm, 7 ¹ / ₄ "
210-488-012	12 mm	185 mm, 7 ¹ / ₄ "



1/2

COTTLE
210-488-009
185 mm
7¹/₄"

COTTLE Hammer mit einem flachen und einem runden Ende
COTTLE Mallet with flat and round end

Artikel-Nr. Cat.No.	Gewicht weight	Länge length
210-240-180	240 g / 8 ¹ / ₄ "	180 mm / 7"



1/2

COTTLE
210-240-180
180 mm
7"



Bipolare Pinzetten Bipolar Forceps

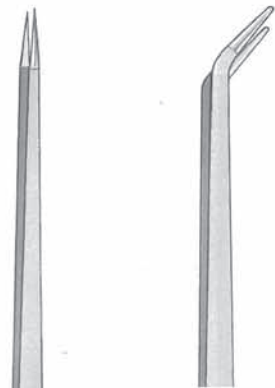

700-600-026
195 mm
7 1/2"



700-600-065
195 mm
7 1/2"



700-600-034
195 mm
7 1/2"

1/1

Bipolare Kabel sind auf Anfrage erhältlich
Bipolar cables are available on request

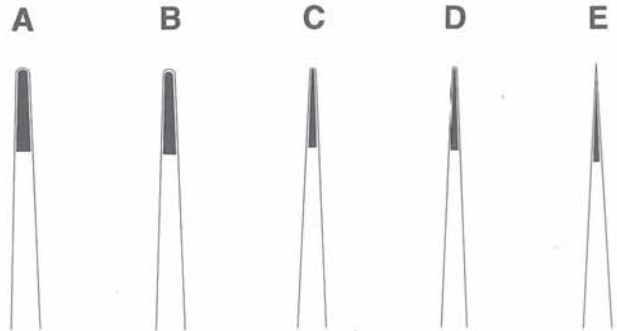

Artikel-Nr. Cat.No.	Länge length	Spitze tip
------------------------	-----------------	---------------

Bipolar Pinzette, Bajonett-Form
Bipolar forceps, bayonet shape

700-600-031	220 mm / 8 3/4"	D
700-600-045	220 mm / 8 3/4"	E
700-600-034	195 mm / 7 1/2"	A
700-600-002	195 mm / 7 1/2"	C
700-600-059	195 mm / 7 1/2"	E
700-600-018	160 mm / 6 1/4"	C
700-600-017	160 mm / 6 1/4"	D
700-600-033	160 mm / 6 1/4"	E

Bipolar Pinzette, Bajonett-Form, abgewinkelt nach unten
Bipolar forceps, bayonet shape, angled, downwards

700-600-063	220 mm / 8 3/4"	D
700-600-026	195 mm / 7 1/2"	E

Bipolar Pinzette, Bajonett-Form, abgewinkelt nach oben
Bipolar forceps, bayonet shape, angled upwards

700-600-065	195 mm / 7 1/2"	D
--------------------	-----------------	---

Bipolar Pinzette, gerade
Bipolar Forceps, straight

700-600-030	220 mm / 8 3/4"	A
700-600-041	220 mm / 8 3/4"	C
700-600-029	195 mm / 7 1/2"	A
700-600-040	195 mm / 7 1/2"	C
700-600-027	160 mm / 6 1/4"	A
700-600-039	160 mm / 6 1/4"	C
700-600-011	160 mm / 6 1/4"	E

Container aus Edelstahl mit Silikoneinlagen
 Stainless steel with silicon pads

Silikon-Andrückleisten
 zum Fixieren der Instrumente
 Silicon protective strips
 for fixation of instruments

Silikon-Noppenstreifen zur schonenden
 Auflage der Instrumente
 Silicon strips for a soft
 and protective storage of the instruments

herausnehmbare Siebplatte
 removable tray insert

Kennzeichnungsschilder
 nach Wahl (Farbe und Text)
 Marking plate
 for selection: colour and description



Deckel ungelocht • mit Bodenlochung •
 Metall-Dauerfilter für Heißluft- und Dampfsterilisation •
 TÜV-geprüft

Lid unperforated • with bottom perforation •
 with metal permanent filters • steam sterilization

Artikel-Nr. Cat.No.	Maße size
600-401-140	200 x 140 x 50 mm
600-401-195	280 x 195 x 50 mm
600-401-255	265 x 255 x 50 mm
600-401-260	380 x 260 x 50 mm

Mit Deckel- und Bodenlochung •
 Mit Textil-Langzeitfiltern für Dampfsterilisation • TÜV-geprüft

With lid and bottom perforation •
 with Textile "Longterm" filters • steam sterilization

Artikel-Nr. Cat.No.	Maße size
600-402-140	200 x 140 x 50 mm
600-402-195	280 x 195 x 50 mm
600-402-255	265 x 255 x 50 mm
600-402-260	380 x 260 x 50 mm



Container für Micro-Neuro Instrumente
Container for Micro-Neuro Instruments

Container aus Edelstahl mit Silikoneinlagen
Stainless steel with silicon pads

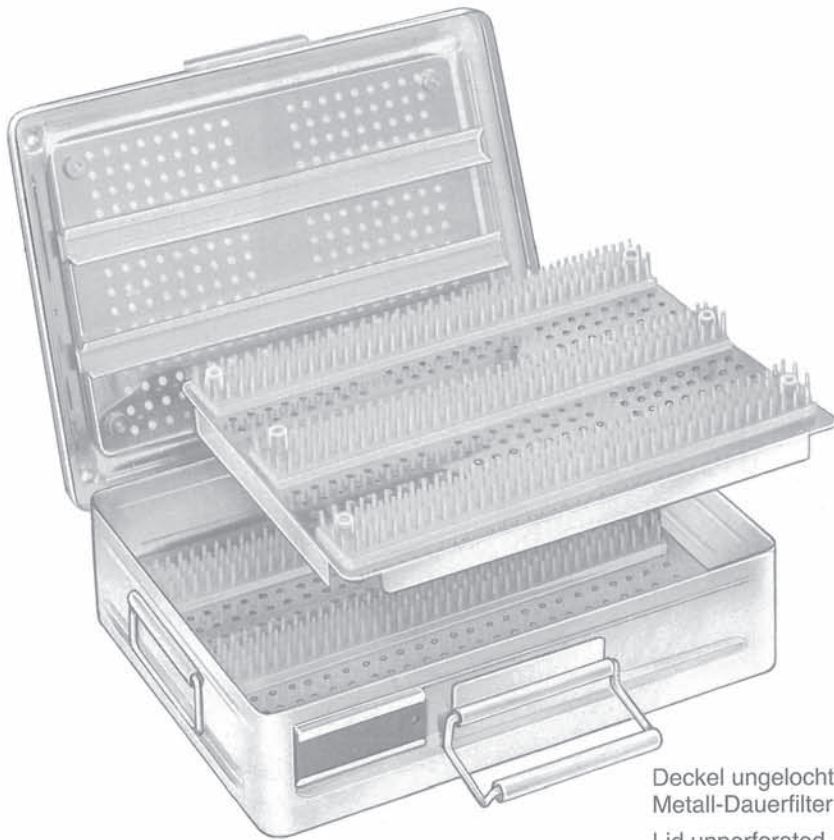

wärmeisolierte Halteknöpfe
zum Herausheben
heat isolated handles

2 herausnehmbare Siebplatten
2 removable tray inserts

Silikon-Andrückleisten
an der Unterseite des Siebes
Silicon protective strips
at the lower side of the tray

Deckel ungelocht • mit Bodenlochung •
Metall-Dauerfilter für Heißluft- und Dampfsterilisation • TÜV-geprüft
Lid unperforated • with bottom perforation •
with metal permanent filters • steam sterilization

Artikel-Nr.
Cat.No.

Maße
size

600-406-140
600-406-195
600-406-255
600-406-260

200 x 140 x 65 mm
280 x 195 x 65 mm
265 x 255 x 65 mm
380 x 260 x 65 mm

Mit Deckel- und Bodenlochung •
Mit Textil-Langzeitfiltern für Dampfsterilisation • TÜV-geprüft
With lid and bottom perforation •
with Textile "Longterm" filters • steam sterilization

Artikel-Nr.
Cat.No.

Maße
size

600-407-140
600-407-195
600-407-255
600-407-260

200 x 140 x 65 mm
280 x 195 x 65 mm
265 x 255 x 65 mm
380 x 260 x 65 mm



Seite		Seite		Seite		
A						
	Aneurysmen Clips	49-55			Landolt Tumor-Faßzange	69
	Anlegezangen	56-58			Lazar Knüpfpinzetten	25
	Atraumapinzetten	27,28			Löffel, Mikro	36,77,78
	Austin Mikro Knüpfpinzette	26			Love-Gruenwald Rongeur	70
					Love Nervwurzelhaken	32
B						
	Barraquer Mikro Nadelhalter	10,11				
	Biemer Anlegepinzette	57				
	Biemer Gefäßclip	57				
	Biemer Gefäßspreizer	48				
	Biemer Venenschere	7,9				
	Biemer Gefäßdilatator	48				
	Bipolar Pinzetten	82				
C						
	Caspar Explorations- und					
	Koagulationshäkchen	31				
	Caspar Rongeur	71				
	Caspar Skalpellgriff	29				
	Castroviejo Mikro Nadelhalter	16				
	Castroviejo Mikro Federschere	18				
	Container	83,84				
	Cottle Meißel	81				
	Cottle Hammer	81				
	Cushing Hirnspatel	67				
	Cushing Rongeur	70				
	Cushing-Landolt Spekula	80				
D						
	DeBakey Gefäßklemmen	59,60				
	DeBakey-Satinsky					
	Gefäßklemmen	60				
	DeBakey Pinzetten	27,28				
	Dissektoren	42-44,76				
E						
	E nukleatoren	76,77				
F						
	Fadengabeln	45				
	Fadenführer	33				
	Fahlbusch Löffel	78				
	Fahlbusch Kürette	78				
	Ferris-Smith-Kerrison Stanze	72				
	Fisch Häkchen	38				
G						
	Galeahaken	67				
	Gefäßclips	57,58				
	Gefäßdilatator	48				
	Gefäßklemmen	59,60				
	Gefäßmesser	37-39				
	Gefäßspreizer	48				
	Gewebekralle	47				
	Glover Gefäßklemmen	60				
	Griff für Gefäßmesser					
	und Häkchen	37				
H						
	Hammer	81				
	Hardy E nukleatoren	76				
	Hardy-Fahlbusch Dissektoren	76				
	Hardy Implantationsgabel	76				
	Hardy Küretten	76				
	Heifetz Hirnspatel	66				
	Heifetz Tumorfaßpinzetten	21				
	Hirnspatel	65				
	Hosobuchi Spatel	77				
	Hunt Pinzette	24				
	Hypophysektomie-					
	Instrumente	74-81				
I						
	Implantationsgabel	76				
J						
	Jacobson Fadengabel	45				
	Jacobson Gefäßmesser	37,38				
	Jacobson Knopfsonden	48				
	Jacobson Mikro Federschere	7,9				
	Jacobson Mikro Nadelhalter	17				
K						
	Kerrison Stanzen	73				
	Knüpfpinzetten	15,25,26				
	Koos Gefäßmesser	39				
	Krayenbühl Nerv-					
	und Gefäßhäkchen	33				
	Küretten	74-78				
L						
	Landolt E nukleatoren	77				
	Landolt Häkchen	77				
	Landolt Küretten	77				
	Landolt Löffel	77				
	Landolt-Reulen Dissektoren	78				
	Landolt-Reulen Häkchen	78				
	Landolt-Reulen Kürette	78				
	Landolt-Reulen Raspatorium	78				
	Landolt Hypophysenzange	69				
	Landolt Skalpellgriffe	30				
	Landolt Spreizzange	80				
M						
	Meißel	81				
	Mikro-Häkchen	38				
	Millesi Mikro Federschere	7,9				
	Müller Gefäßclips	58				
	Müller Fadenklemme	58				
N						
	Nadelhalter,					
	Mikro	1,6,8,10,11,16,17				
	Nagel Mikro Federschere	4				
	Nervhaken	32,33				
	Nicola Küretten	75				
	Nicola Raspatorium	75				
O						
	Okonek-Yasargil Tumorgabeln	46				
	Oldberg Hypophysenzange	69				
	Olivecrona Hirnspatel	67				
P						
	Penfield Dissektoren	44				
	Potts-Yasargil					
	Mikro Federschere	7,9				
R						
	Raney Clipanlage- und					
	Abnehmezange	68				
	Raney Kopfhautklammern	68				
	Raspatorien	34,35,75,78				
	Ray Küretten	74				
	Retraktor-Set	61-65				
	Ring Pinzetten	13				
	Rongeurs	70,71				
	Reill-Mikro Nadelhalter	10				
S						
	Samii Tumorfaßpinzetten	21				
	Samii Tumormesser	40,41				
	Saug und Spülrohr	49				
	Spiegel für Hypophysektomie	79				
	Spurling Rongeurs	70				



Seite

T

Tumorgabeln 46
Titan-Mikroinstrumente 10-15
Titan-Gefäßklemmen 59
Tumorfaßpinzetten 21-24

V

Vannas-Mikrofederscheren 7,9,19
Vise-Mikro Knüpfpinzette 26

Y

Yasargil Aneurysmen Clips 49-55
Yasargil Galeahaken 67
Yasargil Gefäßclips 58
Yasargil Hypophysenzange 69
Yasargil Mikrofederschere 2,3,9
Yasargil Mikronadelhalter 1
Yasargil Mikropinzette 20,21
Yasargil Retraktor Set 61-65
Yasargil Spül- und Saugrohr 79



page	page	page
A		
Aneurysm Clips 49-55		
Applying Forceps 56-58		
Atraumatic Forceps 27,28		
Austin Suture Tying Forceps 26		
B		
Barraquer Micro		
Needle Holder 10,11		
Biemer Applying Forceps 57		
Biemer Vessel Clips 57		
Biemer Vessel Spreader 48		
Biemer Vessel Scissor 7,9		
Biemer Vessel Dilator 48		
Bipolar Forceps 82		
C		
Caspar Exploration- and		
Coagulation Hook 31		
Caspar Rongeurs 71		
Caspar Scalpel Handle 29		
Castroviejo Micro		
Needle Holder 16		
Castroviejo Micro Scissors 18		
Container 83,84		
Cottle Chisel 81		
Cottle Mallet 81		
Cushing Brainspatula 67		
Cushing Rongeur 70		
Cushing-Landolt Specula 80		
D		
DeBakey Vessel Clamps 59,60		
DeBakey-Satinsky		
Vessel Clamp 60		
DeBakey Atraumatic Forceps ... 27,28		
Dissectors 42-44,76		
E		
Enucleators 76,77		
F		
Forks, Suture 45		
Suture Pusher 33		
Fahlbusch Scoop 78		
Fahlbusch Curette 78		
Ferris-Smith-Kerrison Punch 72		
Fisch Hooks 38		
G		
Galea Hooks 67		
Glover Vessel Clamp 60		
H		
Hardy Enucleator 76		
Hardy-Fahlbusch Dissector 76		
Hardy Implant Fork 76		
Hardy Curette 76		
Heifetz Brain Spatula 66		
Heifetz Tumor Grasping Forceps ... 21		
Hosobuchi Spatula 77		
Hunt Tumor Grasping Forceps 24		
I		
Implant Fork 76		
J		
Jacobson 45		
Jacobson Vessel Knife 37,38		
Jacobson Probe with Ball tip 48		
Jacobson Mikro Scissor 7,9		
Jacobson Mikro Needle Holder 17		
K		
Kerrison Punch 73		
Koos Vessel Knife 39		
Krayenbühl Nerve- and Vessel Hooks 33		
L		
Landolt Enucleator 77		
Landolt Hooks 77		
Landolt Curettes 77		
Landolt Scoop 77		
Landolt-Reulen Dissector 78		
Landolt-Reulen Hook 78		
Landolt-Reulen Curette 78		
Landolt-Reulen Raspatory 78		
Landolt Pituitary Forceps 69		
Landolt Skalpel Handle 30		
Landolt Spreader for Specula 80		
Landolt Tumor Grasping Forceps .. 69		
Lazar Suture Tying Forceps 25		
Love-Gruenwald Rongeur 70		
Love Nerve Root Retractor 32		
M		
Mallet 81		
Micro Hooks 38		
Millesi Micro Scissors 7,9		
Müller Vessel Clips 58		
Müller Suture Clamp 58		
N		
Needle holder,		
Micro 1,6,8,10,11,16,17		
Nagel Micro Scissor 4		
Nerve Hooks 32,33		
Nicola Curettes 75		
Nicola Raspatories 75		
O		
Okonek-Yasargil Tumor Fork 46		
Oldberg Pituitary Punch 69		
Olivecrona Brain Spatula 67		
P		
Pituitary Instruments 74-81		
Penfield Dissector 44		
Potts-Yasargil Micro Scissor 7,9		
Punches 70,71		
R		
Raney Applying and		
Removing Forceps 68		
Raney Scalp Haemostasis Clip 68		
Raspatories 34,35,75,78		
Ray Curettes 74		
Retractor Set 61-65		
Ring Forceps 13		
Rongeurs 70,71		
Reill-Micro Needle Holder 10		
S		
Samii Tumor Sgrasping Forceps ... 21		
Samii Tumor Knives 40,41		
Suction and Irrigation Tubes 49		
Spurling Punch 70		
T		
Tumor Fork 46		
Titanium Micro Instruments ... 10-15		
Titanium Vessel Clamps 59		
Tumor Grasping Forceps 21-24		
V		
Vannas Micro Scissors 7,9,19		
Vise-Suture Tying Forceps 26		
Vessel Clamp 59,60		
Vessel Dilator 48		



	page
Vessel Spreader	48
Vessel Clips	57,58
Vessel Knives	37-39

Y

Yasargil Aneurysm Clips	49-55
Yasargil Galea Hook	67
Yasargil Vessel Clips	58
Yasargil Pituitary Punch	69
Yasargil Micro Scissors	2,3,9
Yasargil Micro Needle Holder	1
Yasargil Micro Forceps	20,21
Yasargil Retractor Set	61-65
Yasargil Suction and Irrigation Set	79

Nummernverzeichnis / Numerical Index



Artikel-Nr. Catalogue No.	Seite Page	Artikel-Nr. Catalogue No.	Seite Page	Artikel-Nr. Catalogue No.	Seite Page
140-010-050	60	250-024-835	20	250-064-110	23
140-011-050	60	250-024-836	20	250-064-111	23
140-116-035	59	250-024-837	20	250-064-112	23
140-116-040	59	250-024-840	20	250-064-117	14
140-116-135	59	250-024-841	20	250-064-152	79
140-116-140	59	250-024-845	20	250-064-154	79
140-117-035	59	250-024-846	20	250-064-156	79
140-117-040	59	250-024-850	20	250-064-158	79
140-117-135	59	250-024-851	20	250-064-162	79
140-117-140	59	250-062-150	42	250-064-164	79
140-118-035	59	250-062-151	42	250-064-166	79
140-118-040	59	250-064-011	9	250-064-168	79
140-118-135	59	250-064-012	9	250-064-172	79
140-118-140	59	250-064-013	9	250-064-174	79
140-132-060	60	250-064-014	9	250-064-176	79
140-133-060	60	250-064-015	9	250-064-178	79
140-216-035	59	250-064-016	9	250-064-182	79
140-216-040	59	250-064-017	9	250-064-184	79
140-216-135	59	250-064-018	9	250-064-186	79
140-216-140	59	250-064-019	9	250-064-188	79
140-217-035	59	250-064-020	9	250-064-189	79
140-217-040	59	250-064-021	9	250-064-190	22
140-217-135	59	250-064-022	9	250-064-191	22
140-217-140	59	250-064-023	9	250-064-192	22
140-218-035	59	250-064-024	9	250-064-195	22
140-218-040	59	250-064-028	9	250-064-196	22
140-218-135	59	250-064-030	2	250-064-196	22
140-218-140	59	250-064-031	2	250-064-197	22
210-240-180	81	250-064-032	2	250-064-200	21
210-488-004	81	250-064-033	2	250-064-202	21
210-488-007	81	250-064-034	2	250-064-204	21
210-488-009	81	250-064-035	2	250-064-210	21
210-488-012	81	250-064-036	2	250-064-212	21
250-010-088	31	250-064-037	3	250-064-214	21
250-010-089	31	250-064-038	3	250-064-215	21
250-010-090	31	250-064-039	3	250-064-216	21
250-010-091	31	250-064-040	3	250-064-217	21
250-020-001	16	250-064-043	3	250-064-230	10
250-020-002	16	250-064-044	3	250-064-231	10
250-020-004	16	250-064-045	17	250-064-232	11
250-020-005	16	250-064-046	17	250-064-233	11
250-020-088	31	250-064-047	3	250-064-240	10
250-020-089	31	250-064-048	17	250-064-241	10
250-020-090	31	250-064-049	17	250-064-242	11
250-020-091	31	250-064-050	17	250-064-243	11
250-020-563	16	250-064-051	17	250-064-244	10
250-020-564	16	250-064-056	4	250-064-245	10
250-022-046	29	250-064-057	4	250-064-246	11
250-022-048	29	250-064-059	4	250-064-247	11
250-022-052	29	250-064-060	3	250-064-249	11
250-022-053	30	250-064-061	3	250-064-260	10
250-022-054	29	250-064-076	8	250-064-261	11
250-022-057	30	250-064-079	8	250-064-270	33
250-022-071	30	250-064-080	8	250-064-271	33
250-024-260	25	250-064-081	8	250-064-272	33
250-024-261	25	250-064-089	1	250-064-273	33
250-024-264	25	250-064-092	1	250-064-280	15
250-024-336	26	250-064-093	1	250-064-281	15
250-024-337	26	250-064-096	1	250-064-284	15
250-024-338	26	250-064-097	1	250-064-285	15
250-024-340	26	250-064-099	1	250-064-286	15
250-024-342	26	250-064-100	14	250-064-287	15
250-024-505	26	250-064-101	14	250-064-288	15
250-024-765	24	250-064-103	14	250-064-289	15
250-024-766	23	250-064-105	5	250-064-298	41
250-024-768	23	250-064-106	5	250-064-299	41
250-024-830	20	250-064-107	5	250-064-301	34
250-024-831	20	250-064-108	5	250-064-302	42



Nummernverzeichnis / Numerical Index

Artikel-Nr. Catalogue No.	Seite Page	Artikel-Nr. Catalogue No.	Seite Page	Artikel-Nr. Catalogue No.	Seite Page
250-064-303	34	250-064-562	57	250-065-690	55
250-064-304	34	250-064-568	57	250-065-691	54
250-064-305	34	250-064-569	57	250-065-692	55
250-064-306	48	250-064-600	14	250-065-693	54
250-064-307	48	250-064-601	14	250-065-694	55
250-064-308	48	250-064-603	14	250-065-700	55
250-064-310	48	250-064-701	12	250-065-710	55
250-064-311	48	250-064-702	12	250-065-711	55
250-064-312	48	250-064-703	12	250-065-712	55
250-064-315	45	250-064-704	12	250-065-713	55
250-064-320	35	250-064-705	13	250-065-714	55
250-064-321	35	250-064-706	13	250-065-716	55
250-064-322	35	250-064-707	13	250-065-717	55
250-064-325	36	250-064-708	13	250-065-720	55
250-064-330	38	250-064-851	41	250-065-721	54
250-064-331	38	250-064-854	41	250-065-722	55
250-064-332	42	250-064-856	41	250-065-723	54
250-064-333	42	250-064-858	41	250-065-724	55
250-064-334	42	250-064-861	41	250-065-725	54
250-064-335	36	250-064-864	41	250-065-726	55
250-064-336	36	250-064-866	41	250-065-727	55
250-064-337	34	250-064-868	41	250-065-728	55
250-064-338	34	250-065-005	58	250-065-740	49
250-064-343	43	250-065-010	58	250-065-742	49
250-064-344	43	250-065-011	58	250-065-744	49
250-064-346	35	250-065-012	58	250-065-746	50
250-064-350	38	250-065-013	58	250-065-747	50
250-064-351	39	250-065-014	58	250-065-748	49
250-064-352	39	250-065-020	58	250-065-750	49
250-064-353	39	250-065-021	58	250-065-751	54
250-064-354	39	250-065-022	58	250-065-752	49
250-064-356	39	250-065-023	58	250-065-753	54
250-064-357	39	250-065-024	58	250-065-754	49
250-064-362	37	250-065-540	56	250-065-755	54
250-064-363	37	250-065-542	56	250-065-756	54
250-064-365	39	250-065-544	56	250-065-758	49
250-064-366	39	250-065-548	56	250-065-759	50
250-064-375	38	250-065-550	56	250-065-760	49
250-064-376	38	250-065-552	56	250-065-761	50
250-064-380	46	250-065-554	56	250-065-762	49
250-064-381	46	250-065-558	56	250-065-763	50
250-064-382	46	250-065-600	51	250-065-764	49
250-064-384	46	250-065-602	51	250-065-774	53
250-064-392	47	250-065-603	50	250-065-775	53
250-064-396	33	250-065-604	51	250-065-776	53
250-064-397	33	250-065-610	51	250-065-777	53
250-064-398	33	250-065-612	51	250-065-778	53
250-064-399	33	250-065-613	50	250-065-779	53
250-064-400	40	250-065-614	51	250-065-780	49
250-064-401	40	250-065-620	51	250-065-781	54
250-064-402	40	250-065-622	51	250-065-782	49
250-064-403	40	250-065-623	50	250-065-783	54
250-064-404	40	250-065-624	51	250-065-784	49
250-064-405	40	250-065-640	52	250-065-785	54
250-064-406	40	250-065-642	52	250-065-790	49
250-064-408	40	250-065-644	52	250-065-791	54
250-064-410	40	250-065-648	52	250-065-792	49
250-064-411	40	250-065-650	52	250-065-793	54
250-064-412	40	250-065-652	52	250-065-795	54
250-064-413	40	250-065-654	52	250-065-797	50
250-064-414	40	250-065-658	52	250-065-798	50
250-064-415	40	250-065-660	52	250-065-801	54
250-064-416	40	250-065-662	52	250-065-806	55
250-064-418	40	250-065-664	52	250-065-819	50
250-064-517	58	250-065-668	52	250-065-820	50
250-064-519	58	250-065-680	55	250-065-822	50
250-064-560	57	250-065-681	54	250-065-823	49
250-064-561	57	250-065-682	55	250-065-824	49

Nummernverzeichnis / Numerical Index



Artikel-Nr. Catalogue No.	Seite Page	Artikel-Nr. Catalogue No.	Seite Page	Artikel-Nr. Catalogue No.	Seite Page
250-065-825	49	250-066-305	43	250-066-725	72
250-065-830	50	250-066-307	43	250-066-750	72
250-065-832	50	250-066-309	45	250-066-752	72
250-065-833	50	250-066-310	42	250-066-754	72
250-065-840	49	250-066-311	43	250-066-771	73
250-065-850	50	250-066-312	43	250-066-772	73
250-065-851	50	250-066-345	69	250-066-773	73
250-065-881	53	250-066-599	69	250-066-781	73
250-065-882	53	250-066-600	69	250-066-782	73
250-065-883	53	250-066-605	69	250-066-783	73
250-065-886	53	250-066-608	76	250-066-799	70
250-065-887	53	250-066-609	76	250-066-803	70
250-065-888	53	250-066-611	74	250-066-805	70
250-065-889	53	250-066-614	74	250-066-807	70
250-065-891	53	250-066-616	75	250-066-810	70
250-065-892	53	250-066-617	75	250-066-811	70
250-065-893	53	250-066-618	75	250-066-814	70
250-065-894	53	250-066-619	75	250-069-011	7
250-065-900	56	250-066-620	76	250-069-012	7
250-065-901	56	250-066-621	76	250-069-013	7
250-065-902	56	250-066-622	76	250-069-014	7
250-065-903	56	250-066-623	76	250-069-015	7
250-065-904	56	250-066-624	76	250-069-016	7
250-065-905	56	250-066-625	77	250-069-017	7
250-065-906	56	250-066-626	77	250-069-018	7
250-065-907	56	250-066-627	77	250-069-019	7
250-065-908	56	250-066-628	77	250-069-020	7
250-065-909	56	250-066-629	77	250-069-021	7
250-065-910	56	250-066-630	77	250-069-022	7
250-065-911	56	250-066-631	77	250-069-023	7
250-066-001	68	250-066-632	77	250-069-024	7
250-066-003	68	250-066-635	78	250-069-028	7
250-066-020	67	250-066-637	78	250-069-076	6
250-066-022	67	250-066-640	78	250-069-079	6
250-066-206	70	250-066-641	78	250-069-080	6
250-066-213	67	250-066-642	78	250-069-081	6
250-066-214	67	250-066-643	78	250-069-201	72
250-066-215	67	250-066-644	78	250-069-202	72
250-066-216	67	250-066-655	77	250-069-203	70
250-066-217	67	250-066-656	77	250-069-204	70
250-066-218	67	250-066-666	79	250-069-205	70
250-066-219	67	250-066-668	79	250-069-206	70
250-066-220	65	250-066-670	79	250-069-712	70
250-066-221	65	250-066-672	79	250-069-713	70
250-066-222	65	250-066-674	79	250-069-714	70
250-066-231	66	250-066-682	73	250-069-722	70
250-066-232	66	250-066-683	73	250-069-723	70
250-066-233	66	250-066-684	73	250-069-724	70
250-066-256	66	250-066-685	73	250-069-732	70
250-066-257	66	250-066-692	73	250-069-733	70
250-066-258	66	250-066-693	73	250-069-734	70
250-066-259	66	250-066-694	73	250-069-800	70
250-066-260	61	250-066-695	73	250-069-801	70
250-066-262	61	250-066-711	72	250-069-806	70
250-066-266	62	250-066-712	72	250-069-810	70
250-066-267	62	250-066-712	72	250-069-811	70
250-066-268	62	250-066-713	72	250-069-814	70
250-066-270	62	250-066-714	72	250-150-100	80
250-066-271	65	250-066-715	72	250-150-101	80
250-066-272	65	250-066-716	72	250-150-102	80
250-066-274	62	250-066-717	72	250-150-210	80
250-066-280	63	250-066-718	72	250-164-244	10
250-066-282	63	250-066-719	72	250-164-245	10
250-066-283	63,64	250-066-720	72	250-164-246	11
250-066-285	63,64	250-066-721	72	250-164-247	11
250-066-287	63	250-066-722	72	250-164-260	10
250-066-288	64	250-066-723	72	250-164-261	11
250-066-303	42	250-066-724	72	250-164-284	15



Nummernverzeichnis / Numerical Index

Artikel-Nr. Catalogue No.	Seite Page	Artikel-Nr. Catalogue No.	Seite Page	Artikel-Nr. Catalogue No.	Seite Page
250-164-285	15	250-985-004	71	700-600-018	82
250-164-286	15	250-985-005	71	700-600-026	82
250-164-287	15	250-985-006	71	700-600-027	82
250-164-600	14	250-986-002	71	700-600-029	82
250-164-601	14	250-986-003	71	700-600-030	82
250-164-701	12	250-986-004	71	700-600-031	82
250-164-702	12	250-986-005	71	700-600-033	82
250-164-706	13	250-986-006	71	700-600-034	82
250-220-563	16	290-548-160	28	700-600-039	82
250-220-564	16	290-548-200	28	700-600-040	82
250-249-049	17	290-548-240	28	700-600-041	82
250-264-048	17	290-548-300	28	700-600-045	82
250-264-050	17	290-550-160	27	700-600-059	82
250-264-051	17	290-550-200	27	700-600-063	82
250-264-280	15	290-550-240	27	700-600-065	82
250-264-281	15	290-550-300	27		
250-264-284	15	290-551-160	27		
250-264-285	15	290-551-200	27		
250-264-286	15	290-551-240	27		
250-264-287	15	290-551-300	27		
250-264-288	15	290-552-160	27		
250-264-289	15	290-552-200	27		
250-264-705	13	290-552-240	27		
250-264-706	13	290-552-300	27		
250-264-707	13	290-553-160	27		
250-264-708	13	290-553-200	27		
250-269-076	6	290-553-240	27		
250-269-079	6	290-553-300	27		
250-269-080	6	290-554-160	28		
250-269-081	6	290-554-200	28		
250-364-045	17	290-554-240	28		
250-364-046	17	290-554-300	28		
250-364-284	15	290-555-160	28		
250-364-285	15	290-555-200	28		
250-364-286	15	290-555-240	28		
250-364-287	15	290-555-300	28		
250-364-706	13	290-557-160	27		
250-691-175	44	290-557-200	27		
250-692-195	44	290-557-240	27		
250-693-195	44	290-557-300	27		
250-694-190	32	290-558-160	28		
250-694-215	44	290-558-200	28		
250-695-190	32	290-558-240	28		
250-695-290	44	290-558-300	28		
250-697-190	32	400-133-100	18		
250-980-002	71	400-135-100	18		
250-980-003	71	400-842-085	19		
250-980-004	71	400-843-085	19		
250-980-005	71	400-844-085	19		
250-980-006	71	600-401-140	83		
250-982-002	71	600-401-195	83		
250-982-003	71	600-401-255	83		
250-982-004	71	600-401-260	83		
250-982-005	71	600-402-140	83		
250-982-006	71	600-402-195	83		
250-983-002	71	600-402-255	83		
250-983-003	71	600-402-260	83		
250-983-004	71	600-406-140	84		
250-983-005	71	600-406-195	84		
250-983-006	71	600-406-255	84		
250-984-002	71	600-406-260	84		
250-984-003	71	600-407-140	84		
250-984-004	71	600-407-195	84		
250-984-005	71	600-407-255	84		
250-984-006	71	600-407-260	84		
250-985-002	71	700-600-002	82		
250-985-003	71	700-600-011	82		
		700-600-017	82		

RZ-Medical Supply GmbH wurde von Rainer Zubrod gegründet. Das Firmenziel ist es, hochqualitative medizinische Produkte in den Bereichen Chirurgie, Endoskopie, Mikro-Neurochirurgie, Zahnmedizin, Urologie, HNO und Orthopädie zu wettbewerbsfähigen Preisen zu liefern.

RZ-Medical Supply GmbH entwickelt gemeinsam mit Kunden neue Produkte unter Berücksichtigung der kostengünstigsten Produktionsmethoden, dabei arbeitet die Firma mit langjährig bekannten Herstellern zusammen. Neben Neuentwicklungen liefert **RZ-Medical** auch vorhandene Modelle.

RZ-Medical Supply GmbH was founded by Rainer Zubrod. The company's goal is to supply high quality medical products in Surgery, Endoscopy, Micro-Neuro Surgery, Dental, Urology, ENT and Orthopaedics at competitive prices. By working directly with companies, **RZ-Medical** can assist in the development of new pattern and establishing low-cost manufacturing for new pattern.

RZ-Medical works to establish long-lasting relationship with our customers, providing a direct link to contract manufacturers in Tuttlingen.

RZ-Medical can supply existing pattern and maintain confidentiality for your company's business.

Technische Änderungen vorbehalten.

Dieser Prospekt darf ausschließlich zum An- und Verkauf unserer Erzeugnisse verwendet werden. Nachdruck, auch auszugsweise, verboten.

Technical alterations reserved.

This leaflet is to be used for no other purpose than buying and selling of our products. Reprinting, even partially, is not allowed.



RZ Medizintechnik GmbH

Unter Haslen 20 · D-78532 Tuttlingen

Phone: +49 (0)7462/9470-0

Fax: +49 (0)7462/9470-50

e-mail: sales@rz-medizintechnik.com

<http://www.rz-medizintechnik.com>