

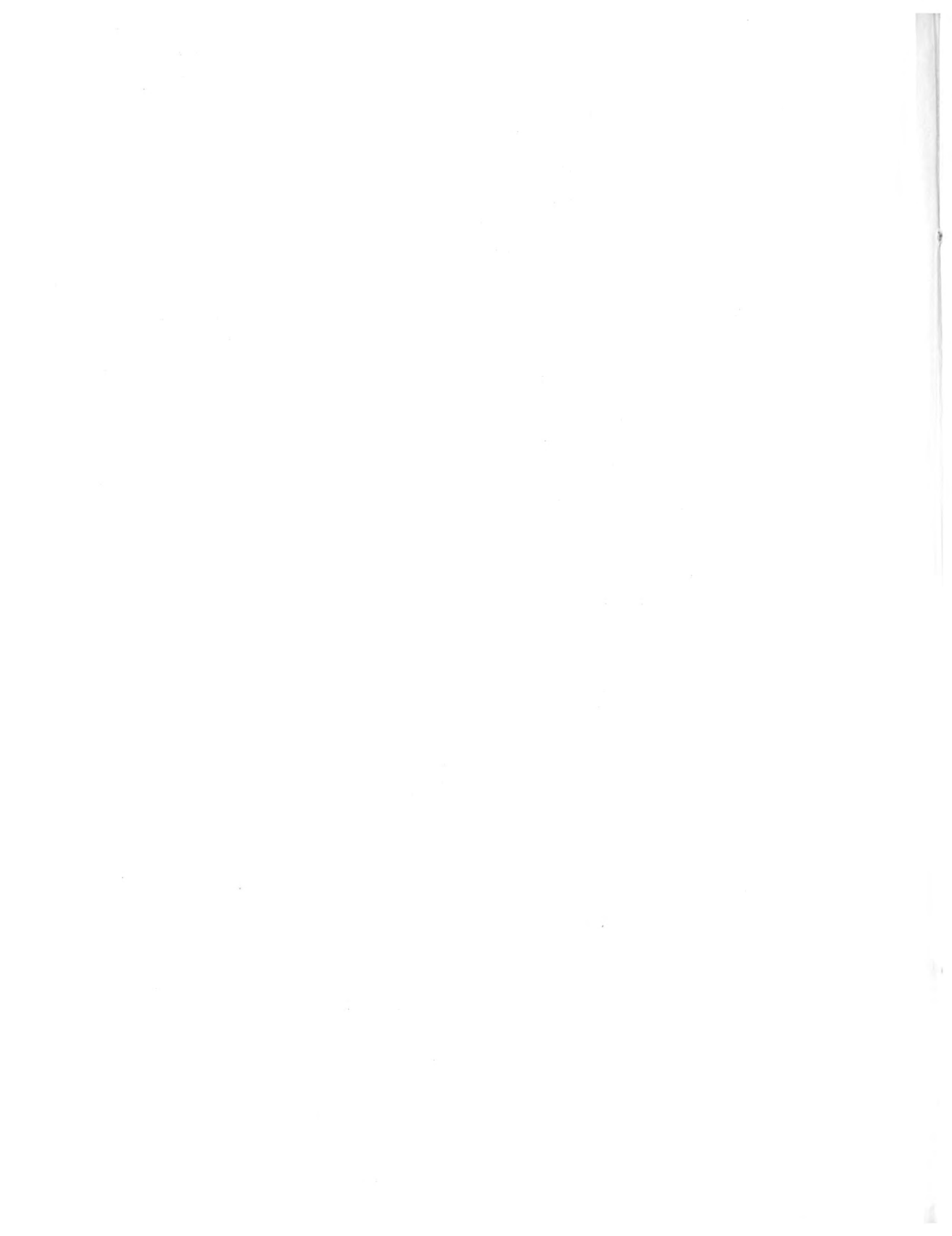

# **HILBRO INSTRUMENTS (PVT) LTD.**

**MANUFACTURERS OF  
DENTAL AND SURGICAL INSTRUMENTS.**

Hilbro Instruments (Pvt) Limited  
Small Industrial Estate, Sialkot, Pakistan  
Tel: +92 (52) 3550922, 3255459  
Fax: +92 (52) 3553439  
Email: [sales@hibro-instruments.com](mailto:sales@hibro-instruments.com)  
[hilinst@brain.net.pk](mailto:hilinst@brain.net.pk)  
Web: [www.hilbro-instruments.com](http://www.hilbro-instruments.com)



dental  
instruments  
catalog

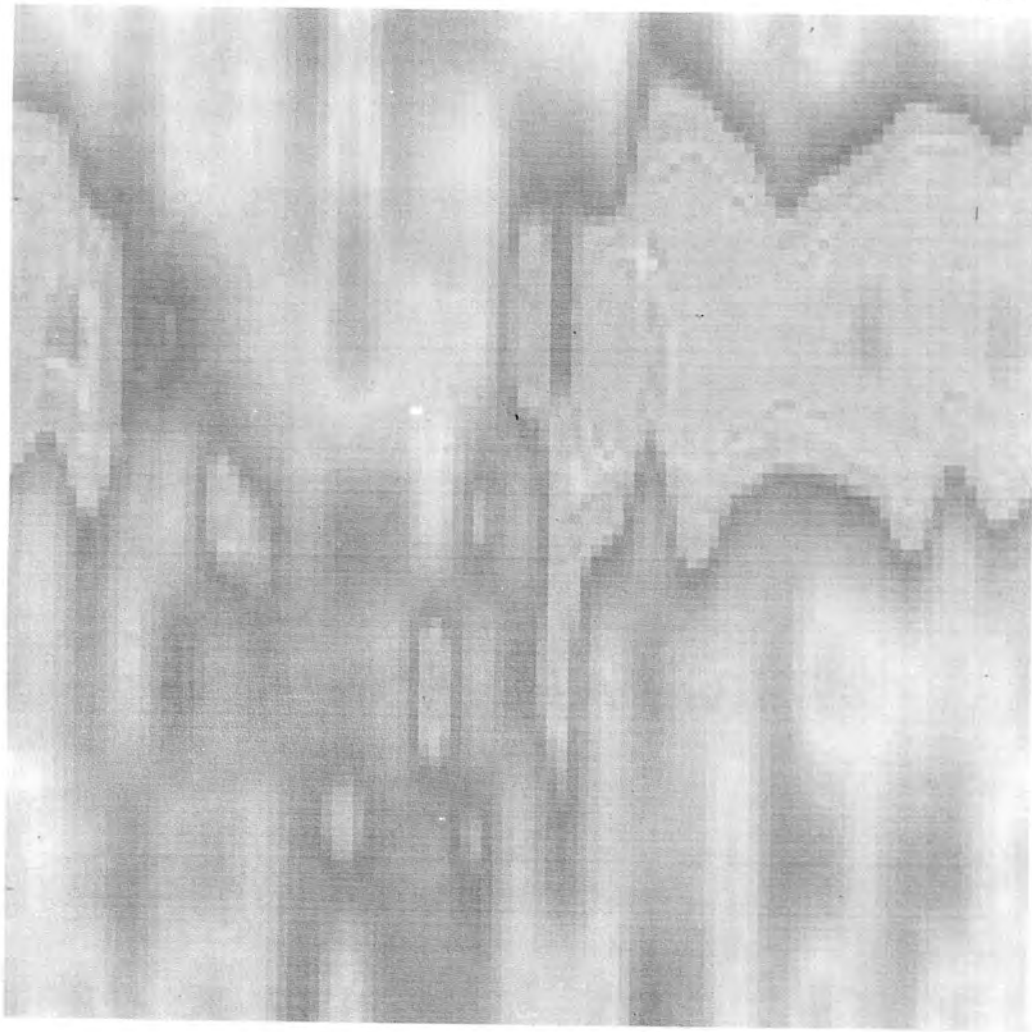

**HILBRO**  
**INSTRUMENTS (PVT) LTD.**  
SMALL INDUSTRIES ESTATE, SIALKOT - PAKISTAN

# OUR MISSION



To produce and sell dental instruments that would meet the Internationally accepted standards.

To continuously and diligently work towards improving and streamlining production and quality control and management procedures.

To ensure that the product is manufactured on cost effective basis.

To create a sense of ownership, pride and accountability among management and other staff through training and reward policy.

To provide quality service to the customer by ensuring that product is produced and delivered to the customer as per the contractual obligation.





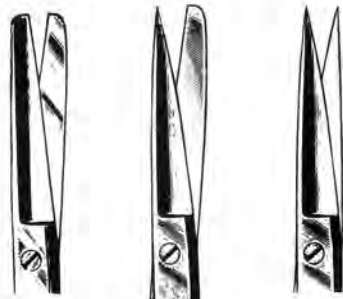

B.B.

S.S.



Standard

|           |           |           |
|-----------|-----------|-----------|
| 10.010.11 | 10.020.11 | 10.030.11 |
| 10.012.13 | 10.022.13 | 10.032.13 |
| 10.014.14 | 10.024.14 | 10.034.14 |
| 10.016.16 | 10.026.16 | 10.036.16 |

|               |
|---------------|
| 11 cm / 4½"   |
| 13 cm / 5¼"   |
| 14 cm / 5½"   |
| 16.5 cm / 6½" |



B.B.

S.S.



Standard

|           |           |           |
|-----------|-----------|-----------|
| 10.011.11 | 10.021.11 | 10.031.11 |
| 10.013.13 | 10.023.13 | 10.033.13 |
| 10.015.14 | 10.025.14 | 10.035.14 |
| 10.017.16 | 10.027.16 | 10.037.16 |

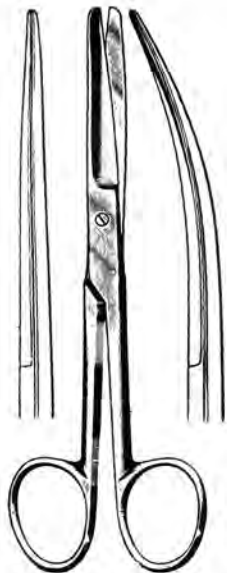

DEAVER

|           |               |           |
|-----------|---------------|-----------|
| 10.040.14 | 14.5 cm / 5½" | 10.041.14 |
|-----------|---------------|-----------|

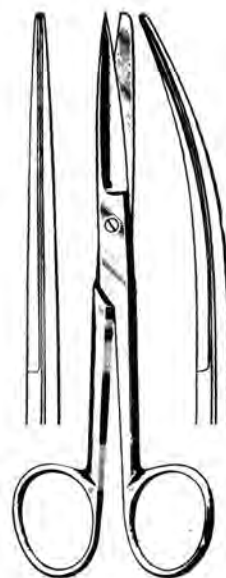

DEAVER

|           |               |           |
|-----------|---------------|-----------|
| 10.042.14 | 14.5 cm / 5½" | 10.043.14 |
|-----------|---------------|-----------|

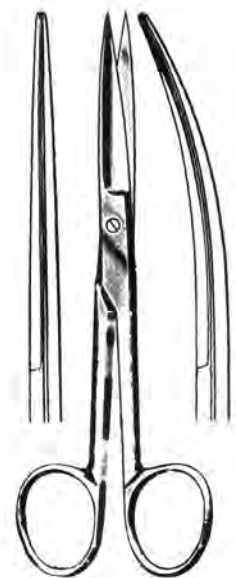

DEAVER

|           |               |           |
|-----------|---------------|-----------|
| 10.044.14 | 14.5 cm / 5½" | 10.045.14 |
|-----------|---------------|-----------|

Operating Scissors  
Tijeras para cirugía  
Chirurgische Scheren

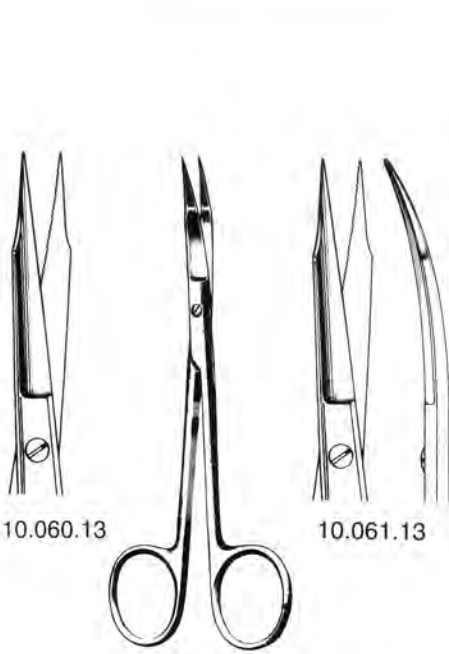

10.060.13

10.061.13

**GOLDMAN FOX**  
13 cm / 5¼"

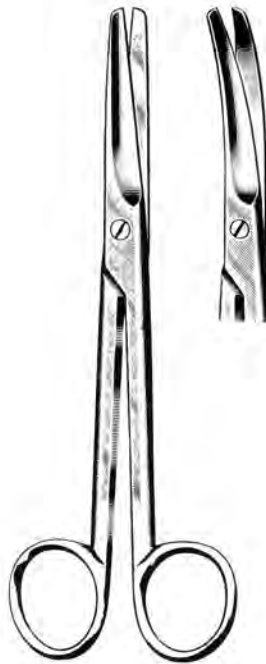

**MAYO**

10.080.14 14 cm / 5½" 10.081.14  
10.082.17 17 cm / 6¾" 10.083.17



**METZENBAUM**

**METZENBAUM**

(Saw Edge)

10.084.14 14.5 cm / 5½" 10.085.14



10.110.14 10.112.14 10.114.14

**METZENBAUM**  
14.5 cm / 5½"



10.111.14 10.113.14 10.115.14

**METZENBAUM**  
14.5 cm / 5½"

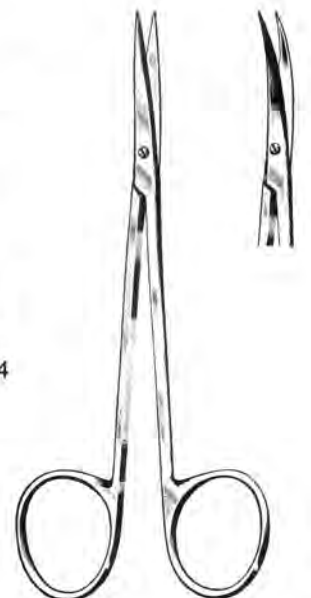

**JOSEPH**  
10.170.14 14 cm / 5½" 10.171.14

Operating and Ligature Scissors.  
Tijeras para cirugía y para ligaduras  
Chirurgische scheren und Ligaturscheren



**SPENCER**  
10.200.09  
9 cm / 3½"



**SPENCER**  
10.202.12  
12 cm / 4¾"



**SHORTBENT**  
10.203.09  
9 cm / 3½"

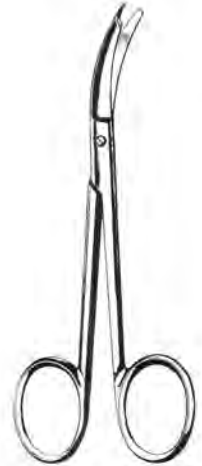

**NORTHBENT**  
10.205.12  
12 cm / 4¾"



**LITTAUER**  
10.210.14  
14 cm / 5½"

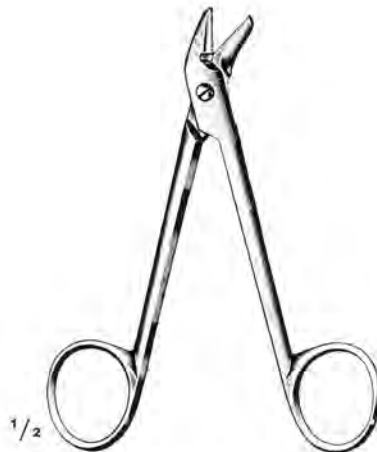

**UNIVERSAL**  
10.240.12  
12 cm / 4¾"

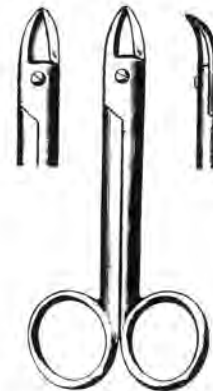

**BEEBEE (Blunt)**  
10.250.10 10.251.10  
10 cm / 4"

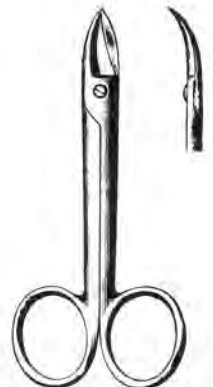

**BEEBEE (Sharp)**  
10.252.10 10.253.10  
10 cm / 4"

Gum Scissors  
 Tijeras para encias  
 Zahnfleischscheren



**QUINBY**  
 10.301.12  
 12.5 cm / 5"



**NEUMANN**  
 10.311.12  
 12 cm / 4 3/4"



**LA-GRANGE**  
 10.313.10  
 10.5 cm / 4"



**LOCKLIN**  
 10.315.16  
 16 cm / 6 1/4" (Saw Edge)



**LOCKLIN**  
 10.317.16  
 16 cm / 6 1/4"



**KELLY**  
 10.350.16 16 cm / 6 1/4" 10.351.16

Gum Scissors  
Tijeras para encias  
Zahnfleischscheren



**DEANS (Saw Edge)**  
10.354.17 10.355.17  
17 cm / 6¾"

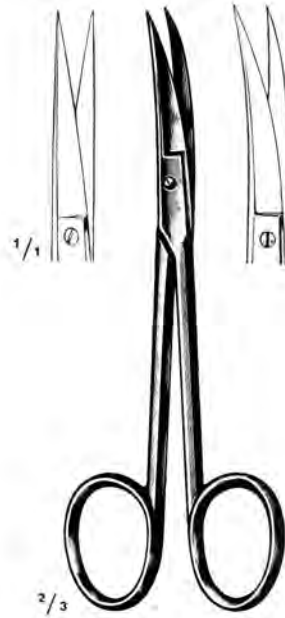

**WAGNER**  
10.356.12 10.357.12  
12 cm / 4¾"

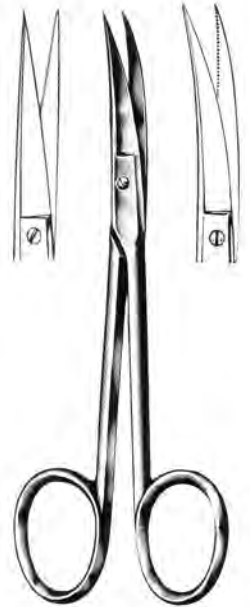

**WAGNER (Saw Edge)**  
10.358.12 10.359.12  
12 cm / 4¾"



11.5 cm / 4½"

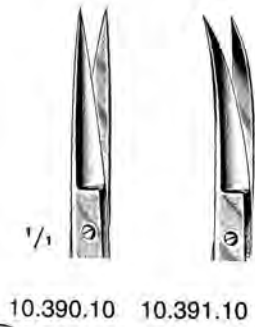

10.390.10 10.391.10



10.393.10 10.395.10

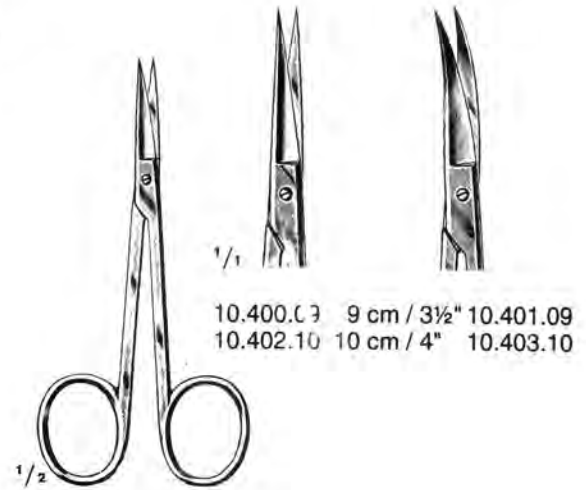

10.400.03 9 cm / 3½" 10.401.09  
10.402.10 10 cm / 4" 10.403.10

Gum Scissors  
 Tijeras para encias  
 Zahnfleischscheren

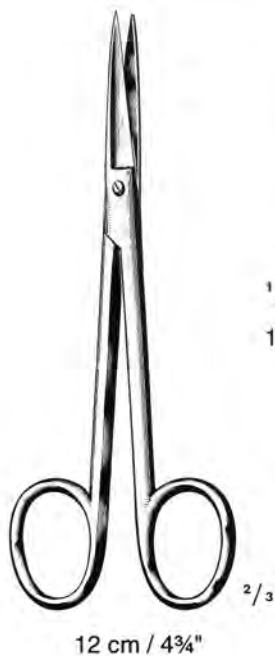

Micro Scissors  
 Micro – Tijeras  
 Mikro - Scheren

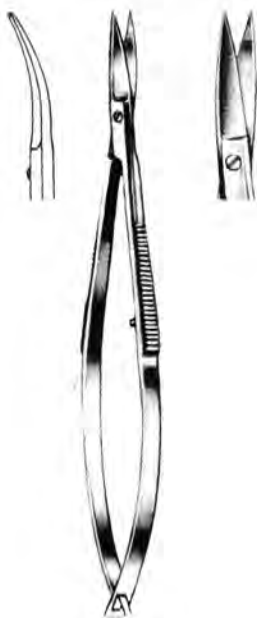

NOYES  
 10.479.12  
 12 cm / 4<sup>3</sup>/<sub>4</sub>"



WESTCOTT (Sharp)  
 10.481.11  
 11.5 cm / 4<sup>1</sup>/<sub>2</sub>"



WESTCOTT (Blunt)  
 10.485.11  
 11.5 cm / 4<sup>1</sup>/<sub>2</sub>"



10.487.14  
 14 cm / 5<sup>1</sup>/<sub>2</sub>"



**TOMATI**  
11.777.19  
19 cm / 7½"



**GOLDMAN FOX**  
11.795.10  
10 cm / 4"



11.890.18  
18 cm / 7"



61.891.18

Dressing and Tissue Forceps  
 Pinzas de disección  
 Anatomische Pinzetten

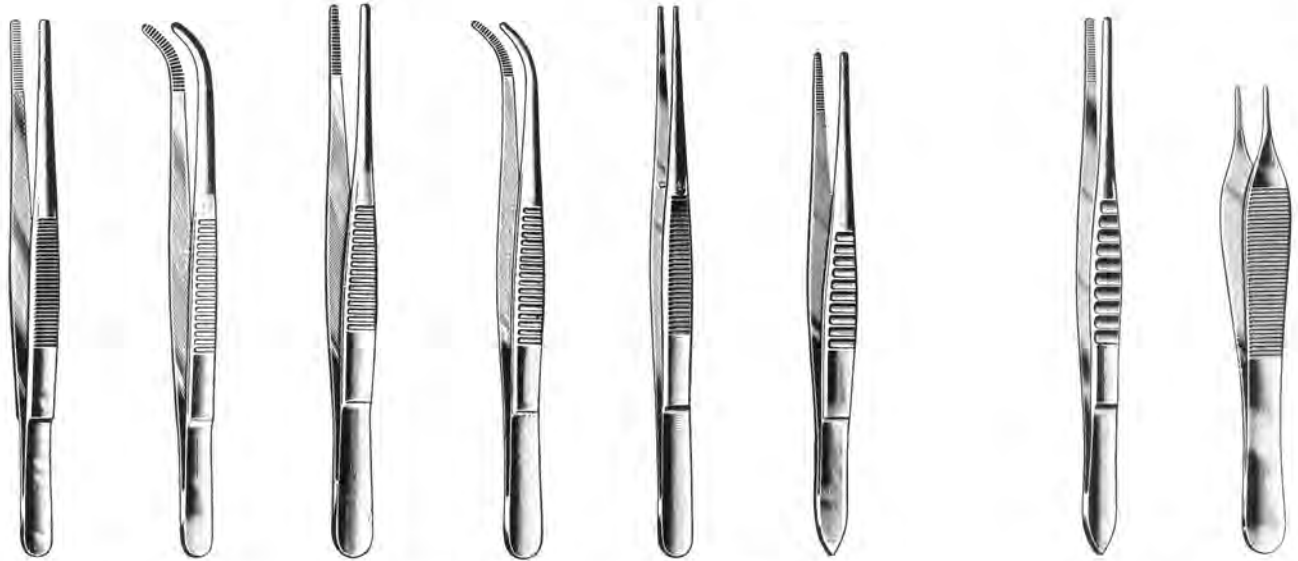

|               | Standard  |           | Narrow    |           |           | Standard  |             | USA Model | ADSON     |
|---------------|-----------|-----------|-----------|-----------|-----------|-----------|-------------|-----------|-----------|
| 11.5 cm / 4½" | 12.032.11 | 12.033.11 | 12.050.11 | 12.051.11 |           | 12.070.12 | 12 cm / 4¾" | 12.080.12 | 12.090.12 |
| 13 cm / 5"    | 12.034.13 | 12.036.13 | 12.052.13 | 12.053.13 | 12.062.13 | 12.071.12 | 13 cm / 5"  | 12.081.13 |           |
| 14.5 cm / 5½" | 12.036.14 | 12.037.14 | 12.054.14 | 12.055.14 | 12.064.14 | 12.072.14 | 14 cm / 5½" | 12.082.14 |           |
| 16 cm / 6¼"   | 12.038.16 | 12.039.16 | 12.056.16 | 12.057.16 |           | 12.073.15 | 15 cm / 6"  | 12.083.15 |           |
| 18 cm / 7"    | 12.040.18 | 12.041.18 | 12.058.18 | 12.059.18 |           | 12.074.18 | 18 cm / 7"  |           |           |
| 20 cm / 8"    | 12.042.20 | 12.043.20 | 12.060.20 | 12.061.20 |           | 12.076.21 | 21 cm / 8¼" |           |           |

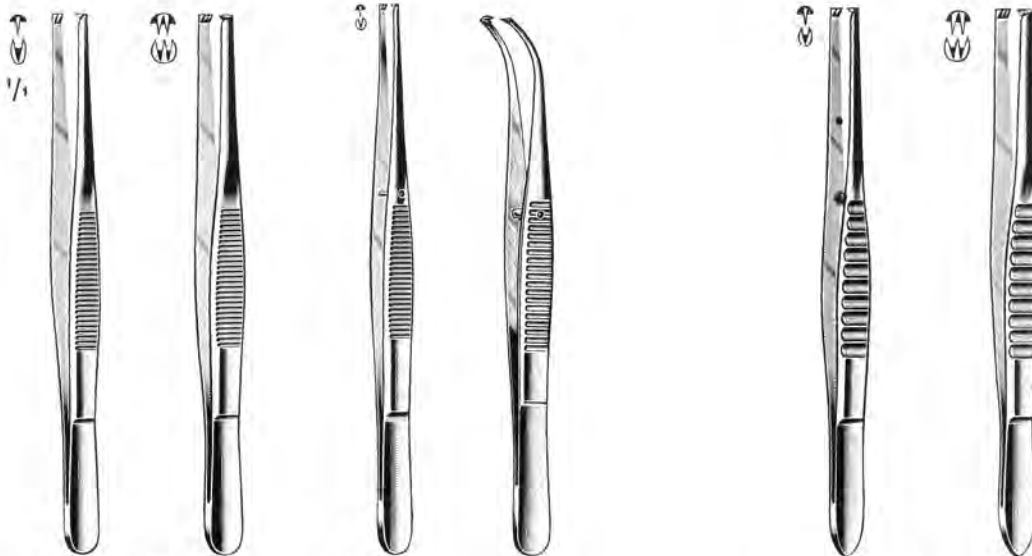

|               | Standard  |           | Narrow    |           |               | USA Model |           |
|---------------|-----------|-----------|-----------|-----------|---------------|-----------|-----------|
| 11.5 cm / 4½" | 12.132.11 | 12.152.11 |           |           | 12 cm / 4¾"   | 12.210.12 |           |
| 13 cm / 5"    | 12.134.13 | 12.154.13 | 12.194.13 | 12.195.13 | 13 cm / 5"    | 12.212.13 | 12.232.13 |
| 14.5 cm / 5½" | 12.136.14 | 12.156.14 | 12.196.14 | 12.197.14 | 14.5 cm / 5½" | 12.214.14 | 12.234.14 |
| 16 cm / 6¼"   | 12.138.16 | 12.158.16 | 12.198.16 | 12.199.16 | 15 cm / 6"    | 12.216.16 | 12.236.16 |
| 18 cm / 7"    | 12.140.18 | 12.160.18 | 12.200.18 | 12.201.18 | 18 cm / 7"    | 12.218.18 |           |
| 20 cm / 8"    | 12.142.20 | 12.162.20 | 12.202.20 | 12.203.20 | 21 cm / 8¼"   | 12.220.21 |           |



Dressing and Tissue Forceps  
 Pinzas de disección  
 Anatomische Pinzetten



**POTTS-SMITH**  
 18 cm / 7 1/4" 12.280.18 12.281.18  
 21 cm / 8 1/4" 12.282.21 12.283.21  
 25 cm / 10" 12.284.25 12.285.25

**POTTS-SMITH**  
 12.310.18 12.311.18  
 12.312.21 12.313.21  
 12.314.25 12.315.25

**ADSON**  
 12.320.12  
 12 cm / 4 3/4"

**ADSON-BROWN**  
 12.330.12  
 12 cm / 4 3/4"

Micro Forceps  
 Micro Pinzas  
 Mikro Pinzetten



**Smooth**  
 9 cm / 3 1/2" 12.550.09 12.551.09  
 10.5 cm / 4 1/4" 12.552.10 12.553.10  
 11.5 cm / 4 1/2" 12.554.11 12.555.11  
 12.5 cm / 5" 12.556.12 12.557.12

**Serrated**  
 12.560.09 12.561.09  
 12.562.10 12.563.10  
 12.564.11 12.565.11  
 12.566.12 12.567.12

Splinter Forceps  
Pinzas para espinas  
Splitterzangen



FEILCHENFELD

|           |              |           |               |
|-----------|--------------|-----------|---------------|
| 12.640.10 | 10.5 cm / 4" | 12.650.07 | 7.5 cm / 3"   |
| 12.642.12 | 12.5 cm / 5" | 12.652.07 | 9 cm / 3½"    |
|           |              | 12.654.11 | 11.5 cm / 4½" |

HUNTER

|           |               |
|-----------|---------------|
| 12.660.10 | 12.661.10     |
|           | 10.5 cm / 4¼" |

WALTER-CARMALT

|           |               |             |
|-----------|---------------|-------------|
| 12.670.10 | 12.671.10     | 12.680.12   |
|           | 10.5 cm / 4¼" | 12 cm / 4¾" |

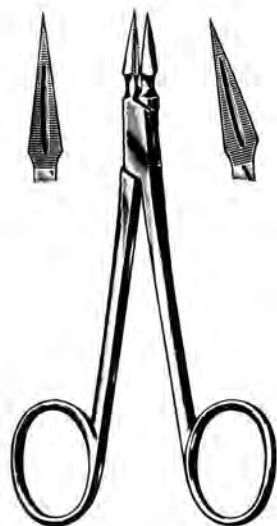

PEET

12.691.11  
11.5 cm / 4½"

ARTHER

12.700.14    12.701.14  
14 cm / 5½"

STIEGLITZ

12.710.14    12.711.14  
14 cm / 5½"

RALK

12.720.15    12.721.15  
15 cm / 6"



**DIEFFENBACH**

14.010.04 4 cm / 1½" 14.011.04  
14.012.05 5.5 cm / 2¼" 14.013.05  
14.014.06 6 cm / 2½" 14.015.06

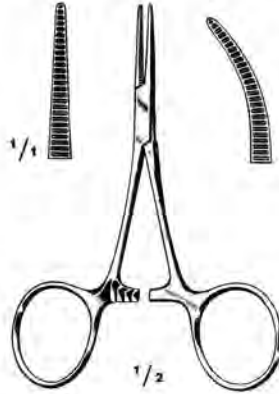

**HARTMANN**

14.030.10 14.031.10  
10 cm / 4"



**HALSTEAD-MOSQUITO**

14.060.12 14.061.12  
12.5 cm / 5"



**HALSTEAD MOSQUITO**

1:2  
14.062.12 14.063.12  
12.5 cm / 5"

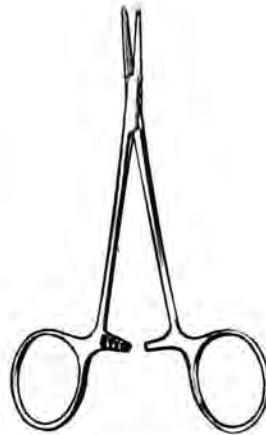

**MICRO MOSQUITO**

14.064.10 10 cm / 4" 14.065.10  
14.066.12 12 cm / 4¾" 14.067.12

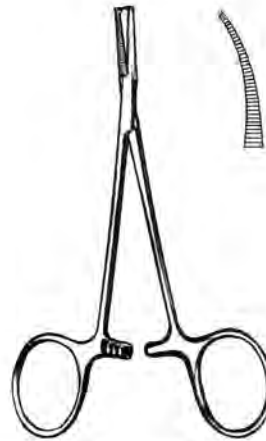

**MICRO MOSQUITO**

1:2  
14.068.10 10 cm / 4" 14.069.10  
14.070.12 12 cm / 4¾" 14.071.12

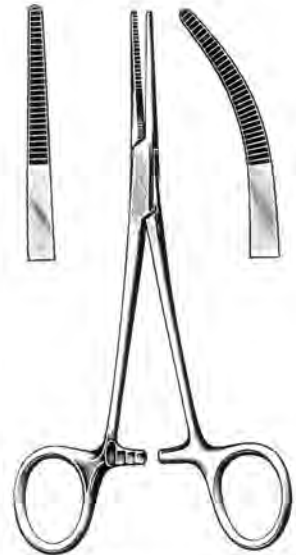

**KELLY**

14.090.14 14.091.14  
14 cm / 5½"

Artery Forceps  
Pinzas hemostáticas  
Arterienklemmen

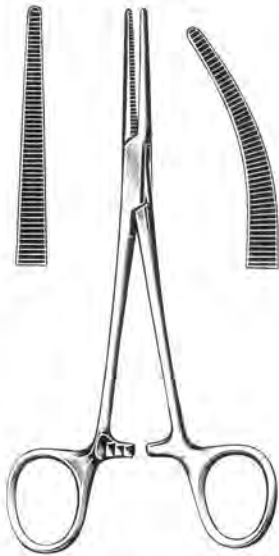

**CRILE**  
14.100.14 14.101.14  
14 cm / 5½"

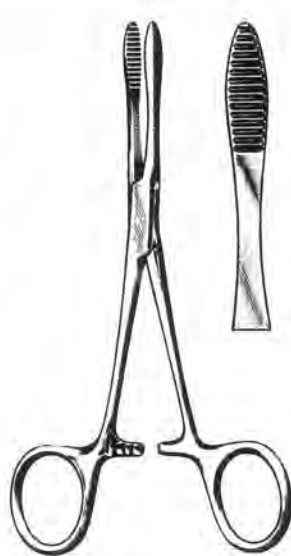

**PEAN**  
14.188.14 14 cm / 5½"  
14.190.16 16 cm / 6½"



**PEAN**  
14.210.14 14.211.14  
14 cm / 5½"

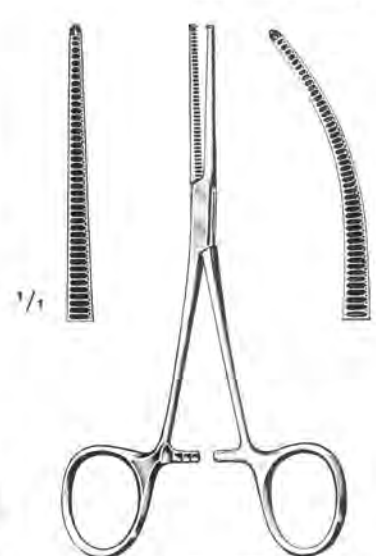

**KOCHER**  
14.370.14 14.371.14  
14 cm / 5½"

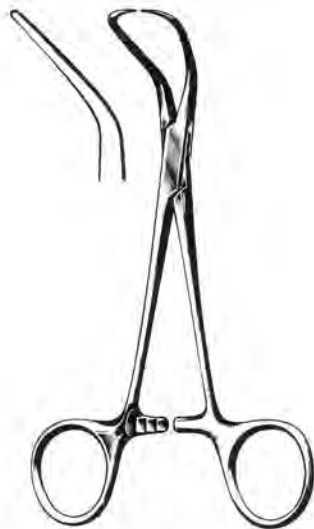

**BACKHAUS**  
14.940.08 8 cm / 3¼"  
14.942.11 11 cm / 4½"  
14.944.13 13 cm / 5"  
14.946.15 15 cm / 6"

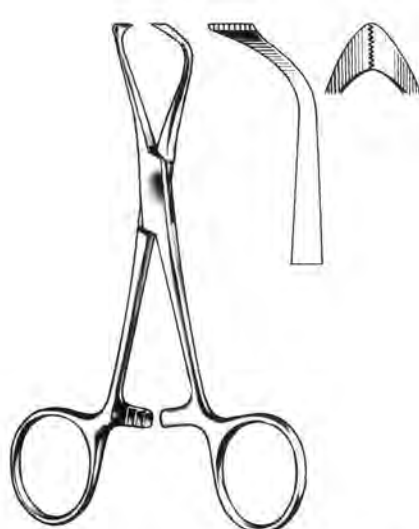

**LORNA**  
14.960.10 10 cm / 4"  
14.960.13 13 cm / 5"



**SCHAEDLE**  
114.1010.09  
9 cm / 3½"



**ENGLISH MODEL**  
14.1020.09  
9 cm / 3½"



**JONES**  
14.1030.09  
9 cm / 3½"



**GROSS-MAIER**

16.030.18 18 cm / 7" 16.031.18  
16.032.20 20 cm / 8" 16.033.20

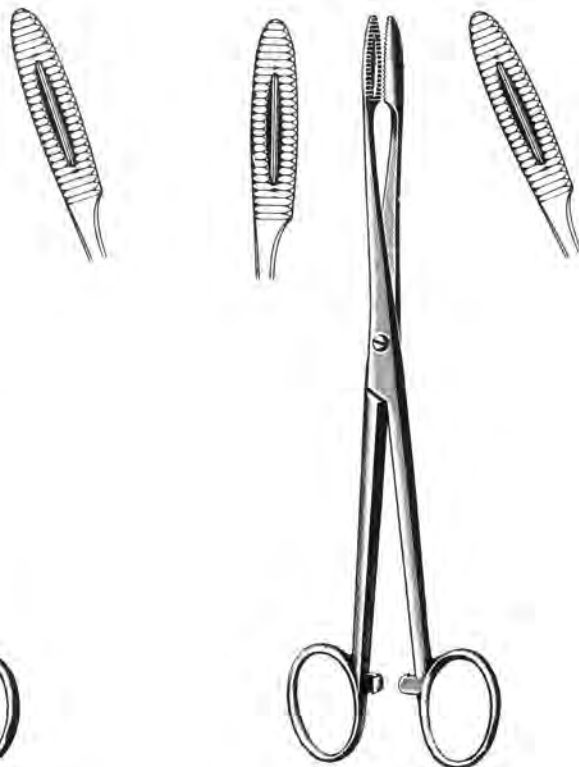

**GROSS-MAIER**

16.034.18 18 cm / 7" 16.035.18  
16.036.20 20 cm / 8" 16.037.20

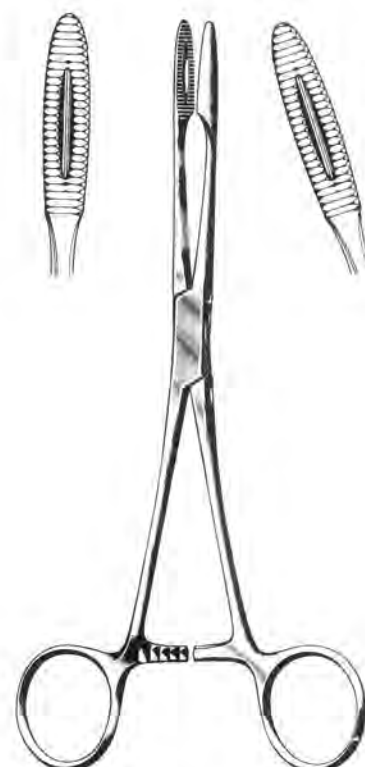

**GROSS-MAIER**

16.038.20 20 cm / 8" 16.039.20  
16.040.25 25 cm / 10" 16.041.25

Needle Holders  
 Porta – agujas  
 Nadlehalter

TRUGRIP TC  
 TRUGRIP TC  
 TRUGRIP TC



**DERF**  
 21.010.12  
 12.5 cm / 5"

**HEGAR-BAUMGARTNER**  
 21.040.13 13 cm / 5"  
 21.042.14 14 cm / 5½"

**CRILEWOOD**  
 21.050.15  
 15 cm / 6"

**MAYO-HEGAR**  
 21.060.16 16 cm / 6¼"  
 21.062.18 18 cm / 7"  
 21.064.20. 20 cm / 8"



**OLSEN-HEGAR**  
 21.220.17  
 17 cm / 6¾"

**OLSEN-HEGAR**  
 21.230.14 14 cm / 5½"  
 21.232.18 18 cm / 7"

**MATHIEU**  
 21.260.14 14 cm / 5½"  
 21.262.17 17 cm / 6¾"

**ARRUGA**  
 21.310.16  
 16 cm / 6¼"



**DERF**  
22.010.12  
12 cm / 4¾"



**DERF**  
22.012.12  
12.5 cm / 5"



**COLLIER**  
22.020.12  
12.5 cm / 5"

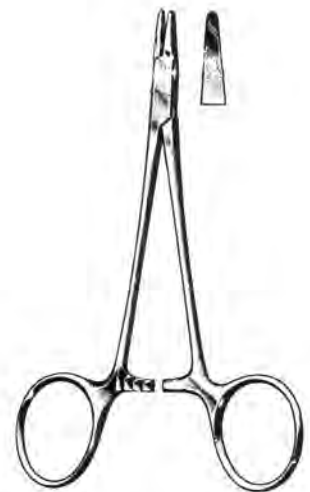

**WEBSTER**  
22.030.13  
13 cm / 5"

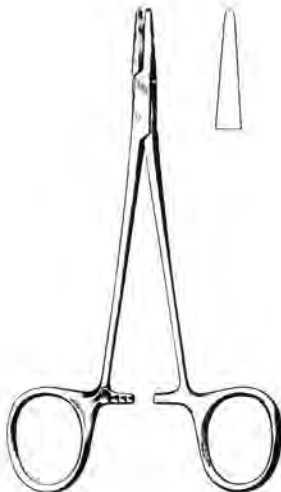

**HALSEY**  
22.040.13  
13 cm / 5"

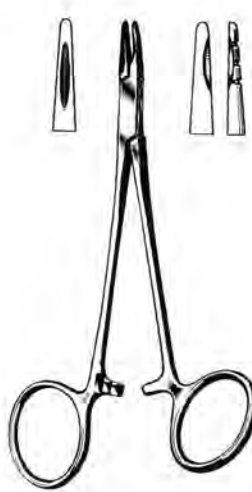

**NEIVERT**  
22.050.13  
13 cm / 5"



**HEGAR-BAUMGARTNER**  
22.060.14  
14 cm / 5½"

Needle Holders  
 Porta - agujas  
 Nadlehalter



**FERRIS-SMITH**  
 22.078.15  
 15 cm / 6"



**CRILE-MURRAY**  
 22.080.15  
 15 cm / 6"



**CRILE-WOOD**  
 22.090.15  
 15 cm / 5"



**MAYO HEGAR**

- |           |             |           |
|-----------|-------------|-----------|
| 22.100.14 | 14 cm / 5½" | 22.101.14 |
| 22.102.16 | 16 cm / 6¼" | 22.103.16 |
| 22.104.18 | 18 cm / 7"  | 22.105.18 |
| 22.106.20 | 20 cm / 8"  | 22.107.20 |

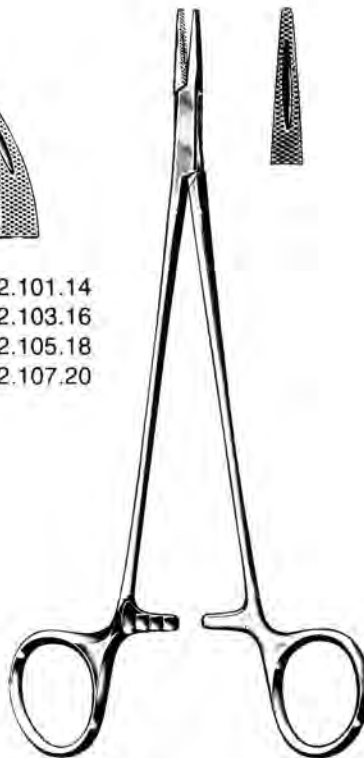

**MAYO HEGAR**  
 22.114.16 16 cm / 6¼"  
 22.116.16 18 cm / 7"  
 22.118.16 20 cm / 8"



**OLSEN-HEGAR**  
 22.280.14  
 14 cm / 5½"



Needle Holders  
Porta - agujas  
Nadlehalter



**OLSEN-HEGAR**  
22.282.14 14 cm / 5½"  
22.284.18 18 cm / 7"



**OLSEN HEGAR**  
22.286.17  
17 cm / 6¾"





**GILLIES**  
22.290.16  
16 cm / 6¼"



**CRILE**  
22.300.15  
15 cm / 6"



**MATHIEU**

|             |   |   |   |
|-------------|---|---|---|
|             |  |  |  |
| 14 cm / 5½" | 22.320.14   | 22.330.14   | 22.340.14   |
| 17 cm / 6¾" | 22.322.17   | 22.330.17   | 22.340.17   |

Needle Holders  
 Porta - agujas  
 Nadlehalter



**BOYNTON**  
 22.400.12  
 12 cm / 4¾"

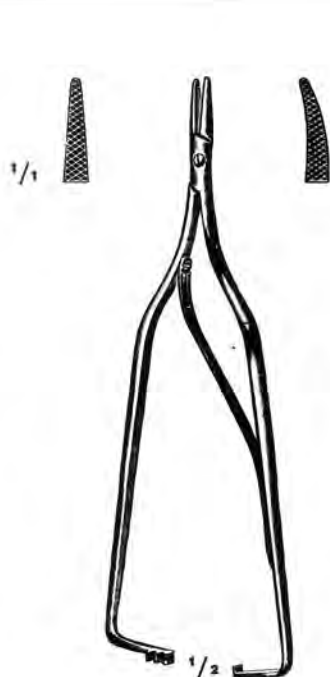

**ARRUGA**  
 21.410.16 22.411.16  
 16 cm / 6¼"



**CASTROVIEJO**  
 22.452.09  
 9 cm / 3½"



**CASTROVIEJO**  
 22.453.09  
 9 cm / 3½"



**BARRAQUER**  
 22.460.10  
 10 cm / 4"



**BARRAQUER**  
 22.461.10  
 10 cm / 4"



**CASTROVIEJO**  
 22.480.12  
 12 cm / 4¾"



**CASTROVIEJO-  
 BARRAQUER**  
 22.491.12  
 12 cm / 4¾"



**CASTROVIEJO**  
 22.500.13  
 13 cm / 5¼"

Reverding Needles  
Agujas de Reverdin  
Reverdin Nadeln



**REVERDIN**  
14 cm / 5½"  
19 cm / 7¼"



Fig. 1  
22.511.14  
22.521.19



2  
22.512.14  
22.522.19



3  
22.513.14  
22.523.19



4  
22.514.14  
22.524.19

Awls  
Lezna  
Ahle



For Lower Jaw  
22.545.13  
13 cm / 5¼"



For Upper Jaw  
22.546.18  
18 cm / 7¼"



**LISTER**  
24.014.14 14.5 cm / 5½"  
24.016.18 18 cm / 7¼"

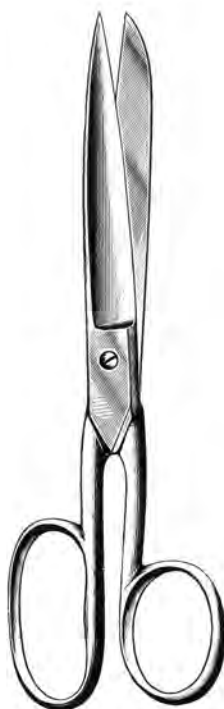

**SMITH**  
24.030.16 16 cm / 6¼"  
24.032.18 18 cm / 7¼"  
24.034.20 20 cm / 8"



**UNIVERSAL**  
24.080.14 14 cm / 5½"  
24.082.18 18 cm / 7¼"

Mallets  
Martillos y Mazos  
Hämmer



1/3

**WILLIGER**  
24 cm / 9½"



28.260.01  
26 mm ø  
300 gr / 10½ oz



28.260.02  
28 mm ø  
340 gr / 12 oz



28.260.03  
30 mm ø  
400 gr / 14 oz



1/2

28.260.16  
20 mm ø  
140 gr / 8 oz



**MEAD**  
28.320.17  
26 mm ø  
320 gr / 11¼ oz



**PARTSCH**  
28.322.18  
18 cm / 7"



**MEAD**  
28.324.19  
19.5 cm / 7¾"

Bone Curettes  
Cucharillas cortantes  
Scharfe Löffel

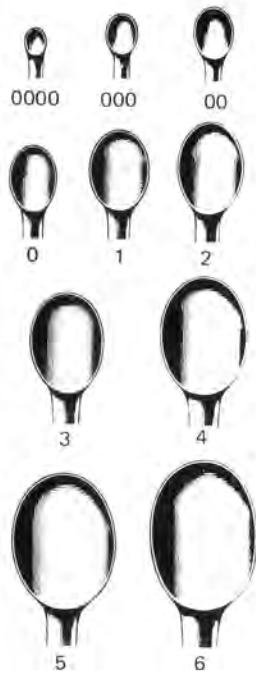

| VOLKMANN  | fig. |
|-----------|------|
| 28.347.17 | 0000 |
| 28.348.17 | 000  |
| 28.349.17 | 00   |
| 28.350.17 | 0    |
| 28.351.17 | 1    |
| 28.352.17 | 2    |
| 28.353.17 | 3    |
| 28.354.17 | 4    |
| 28.355.17 | 5    |
| 28.356.17 | 6    |

| BRUNS     | fig. |
|-----------|------|
| 28.367.17 | 0000 |
| 28.368.17 | 000  |
| 28.369.17 | 00   |
| 28.370.17 | 0    |
| 28.371.17 | 1    |
| 28.372.17 | 2    |
| 28.373.17 | 3    |
| 28.374.17 | 4    |
| 28.375.17 | 5    |
| 28.376.17 | 6    |

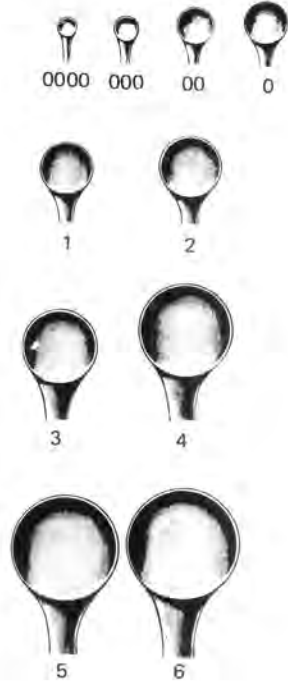

BRUNS  
17 cm / 6 3/4"

VOLKMANN  
17 cm / 6 3/4"



| SCHEDE    | fig. |
|-----------|------|
| 28.388.17 | 000  |
| 28.389.17 | 00   |
| 28.390.17 | 0    |
| 28.391.17 | 1    |
| 28.392.17 | 2    |
| 28.393.17 | 3    |
| 28.394.17 | 4    |

| SPRATT    | fig. |
|-----------|------|
| 28.408.17 | 000  |
| 28.409.17 | 00   |
| 28.410.17 | 0    |
| 28.411.17 | 1    |
| 28.412.17 | 2    |
| 28.413.17 | 3    |
| 28.414.17 | 4    |
| 28.415.17 | 5    |

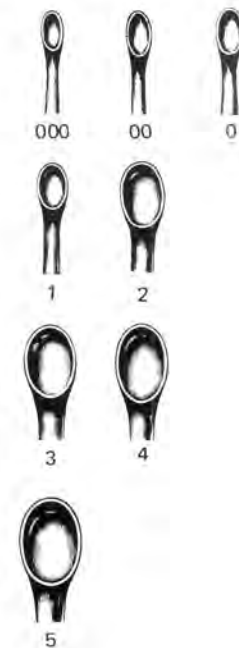

SPRATT  
16.5 cm / 6 1/2"

SCHEDE  
17 cm / 6 3/4"

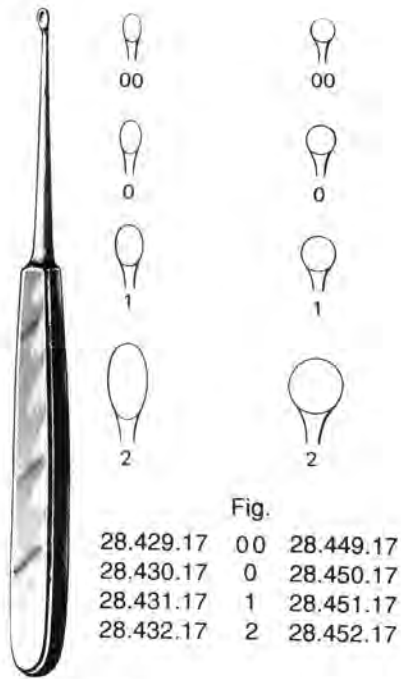

| Fig.      |    |           |
|-----------|----|-----------|
| 28.429.17 | 00 | 28.449.17 |
| 28.430.17 | 0  | 28.450.17 |
| 28.431.17 | 1  | 28.451.17 |
| 28.432.17 | 2  | 28.452.17 |

**WILLIGER**  
17.5 cm / 7"

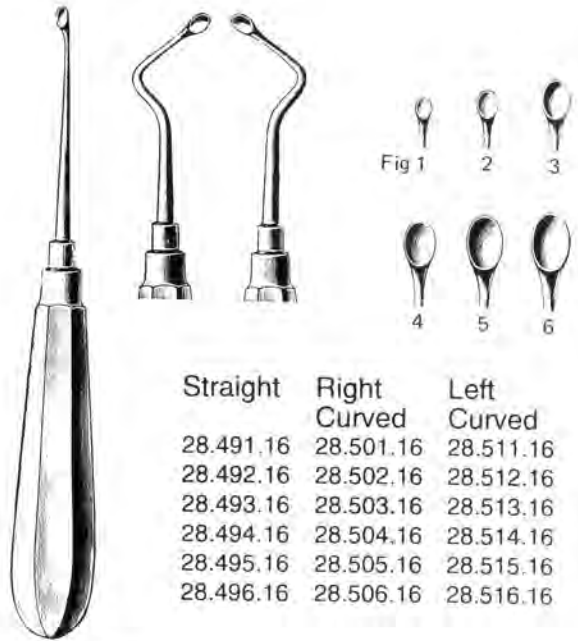

| Straight  | Right Curved | Left Curved |
|-----------|--------------|-------------|
| 28.491.16 | 28.501.16    | 28.511.16   |
| 28.492.16 | 28.502.16    | 28.512.16   |
| 28.493.16 | 28.503.16    | 28.513.16   |
| 28.494.16 | 28.504.16    | 28.514.16   |
| 28.495.16 | 28.505.16    | 28.515.16   |
| 28.496.16 | 28.506.16    | 28.516.16   |

**USA MODEL**  
16 cm. / 6¼"



**WILLIGER**  
13.5 cm / 5¼"

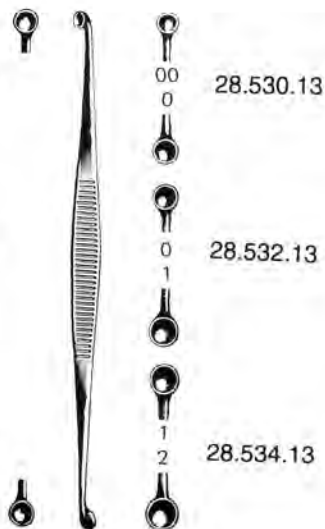

**MARTINI**  
13.5 cm / 5¼"

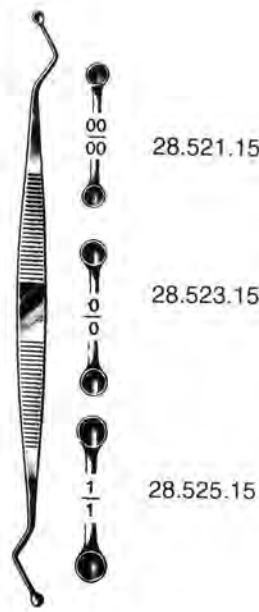

**WILLIGER**  
15.5 cm / 6"

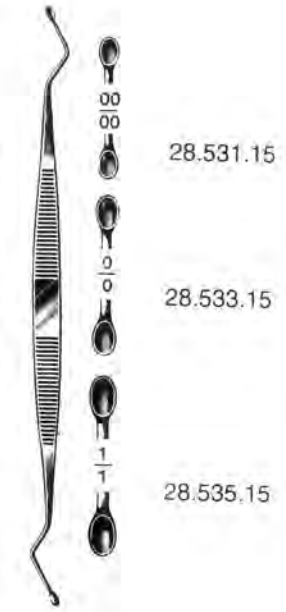

**MARTINI**  
15.5 cm / 6"



**MOLT/DOYEN**  
 48.010.11  
 11 cm / 4½"



**MOLT/DOYEN**  
 48.012.14  
 14 cm / 5½"



**DENHART**  
 48.020.12  
 12 cm / 4¾"



**ROSER KONIG**  
 48.030.16 16 cm / 6¼"  
 48.032.19 19 cm / 7½"



**FERGUSON**  
 Ackland Jaws Parallel Jaws  
 48.040.16 16 cm / 6¼" 48.050.16  
 48.042.19 19 cm / 7¼" 48.052.19



**FERGUSON**  
 Ackland Jaws Parallel Jaws  
 48.060.15 15 cm / 6¼" 48.070.15  
 48.062.19 19 cm / 7¼" 48.072.15



**BUXTON**  
 Ackland Jaws Parallel Jaws  
 48.080.00 48.082.00



**HEISTER**  
 48.090.13  
 13 cm / 5"





**WHITE HEAD**  
48.140.11 11 cm / 4¼"  
48.142.13 13 cm / 5"  
48.144.15 15 cm / 6"

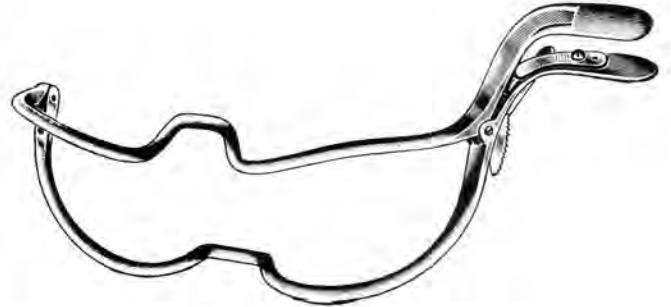

**WHITE HEAD**  
48.160.09 9 cm / 3½"  
48.162.11 11 cm / 4¼"  
48.164.13 13 cm / 5"  
48.166.15 15 cm / 6"

Finger Protector  
Dadeles  
Fingerschützer



**LANGEN BECK**  
48.171.01 48.171.02 48.171.03



**MAYO**  
 48.190.17  
 17 cm / 6¾"



48.200.14  
 14.5 cm / 5¾"



48-210.14  
 14.5 cm / 5¾"



**DOYEN**  
 48.220.13 13 cm / 5"  
 48.222.16 16 cm / 6¼"



**BRUENINGS**  
 48.230.19  
 19 cm / 7½"



**COLLIN**  
 48.240.16  
 16.5 cm / 6½"



**FRENZEL**  
 48.250.16  
 16.5 cm / 6½"

Tongue Depressors, Cheek and Lip Retractors  
 Abaja - lenguas, Sparadores para lablos y majillas  
 Züngendrucker, Wangen - und Lippenhalter



48-290.14  
14 cm / 5 1/4"

1/1



48-292.15  
15 cm / 6"



1/2

LE MEE  
48.294.00



STERNBERG

- 48.296.12 12 cm / 4 3/4"
- 48.296.14 14 cm / 6 1/4"
- 48.296.16 16 cm / 6 1/4"
- 48.296.18 18 cm / 7"



STERNBERG

- 48-297.12
- 48.297.14
- 48.297.16
- 48.297.18



1/2

SIMPLEX

- 48.298.11
- 11 cm / 4 1/2"



UNIVERSITY OF

- MINNESOTA
- 48.299.14
- 14 cm / 5 1/2"

Tongue Holding Forceps  
 Pinzas tira - lengua  
 Zungenzangen



COLLIN  
 48.310.16  
 16 cm / 6¼"



COLLIN  
 48.312.17 17 cm / 6¾"  
 48.314.19 19 cm / 7½"



YOUNG  
 48-340.17  
 17 cm / 6¾"

Cleft Palate Needles and Knives  
 Aguja y bisturí para del paladar  
 Nadeln zur Gaumennaht

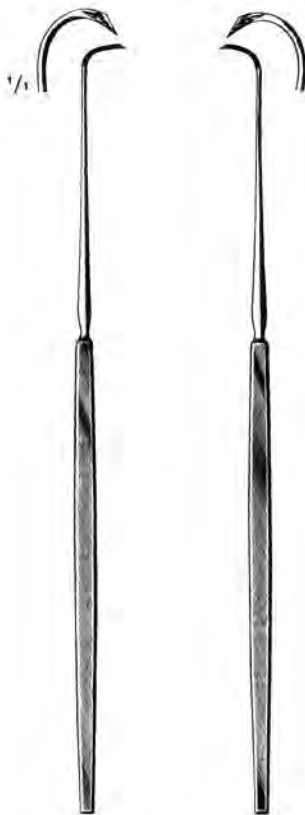

DURHAM  
 50.020.25 50.022.25  
 25 cm / 10"



DAY  
 50.070.21  
 21.5 cm / 8½"



ABRAHAM  
 50.080.21  
 21 cm / 8¼"



CANFIELD  
 50.090.21  
 21 cm / 8¼"



1/1

Fig. 1  
 60.001.00  
 to  
 60.235.00

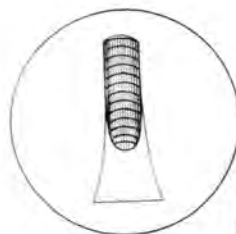

Fig. 1  
 60.901.00  
 to  
 60.979.00

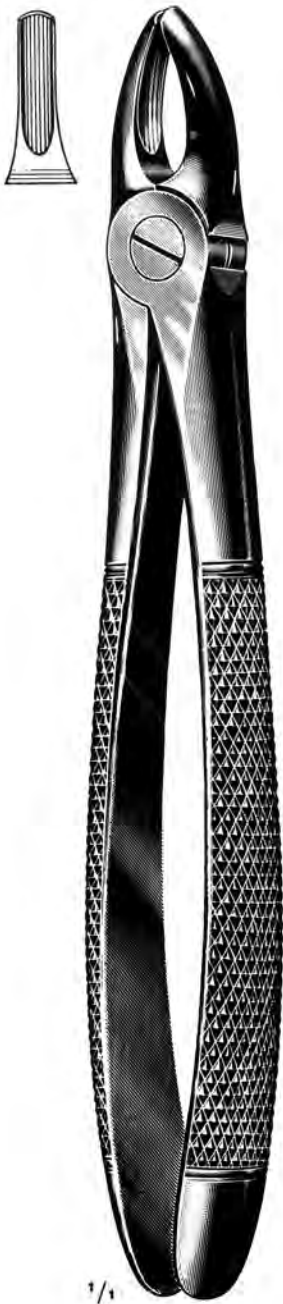

Fig. 1  
 60.001.00

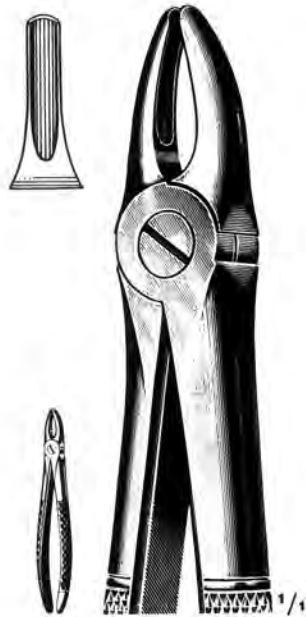
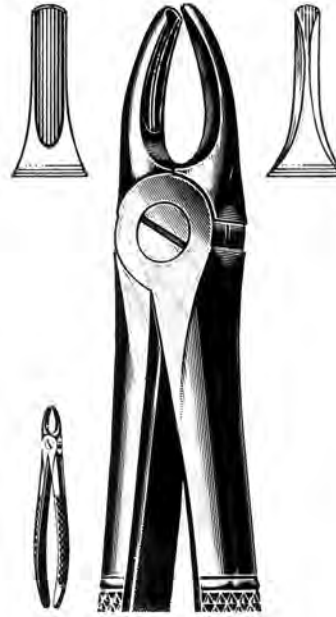

Fig. 2  
 60.002.00  
 60.902.00



3  
 60.003.00



4  
 60.004.00  
 60.904.00



Fig. 7  
 60.007.00  
 60.907.00



8  
 60.008.00



13  
 60.013.00  
 60.913.00



Fig. 17  
60.017.00  
60.917.00



Fig. 18  
60.018.00  
60.918.00



18 A  
60.018.01



19  
60.019.00



Fig. 20  
60.020.00



21  
60.021.00  
60.921.00



22  
60.022.00  
60.922.00



Extracting Forceps  
Forceps De Extraccion  
Zahnzangen

English Pattern  
Forma Inglesa  
Englische Form



Fig. 23  
60.023.00



24  
60.024.00



29  
60.029.00

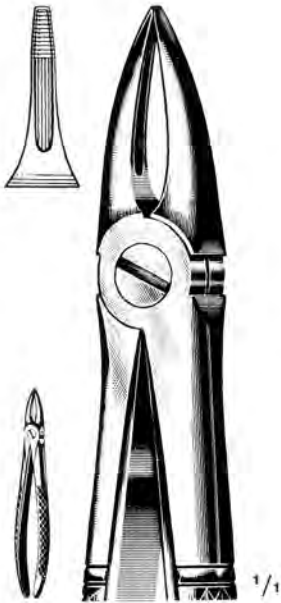
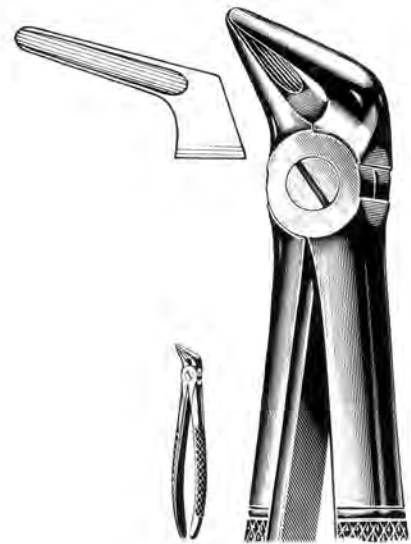

Fig. 29 N  
60.029.07



30  
60.030.00



31  
60.031.00





Fig. 32  
60.032.00



33  
60.033.00  
60.933.00



33 A  
60.033.01



Fig. 33 C  
60.033.03



33 M  
60.033.06

Extracting Forceps  
Forceps De Extraccion  
Zahnzangen

English Pattern  
Forma Inglesa  
Englische Form

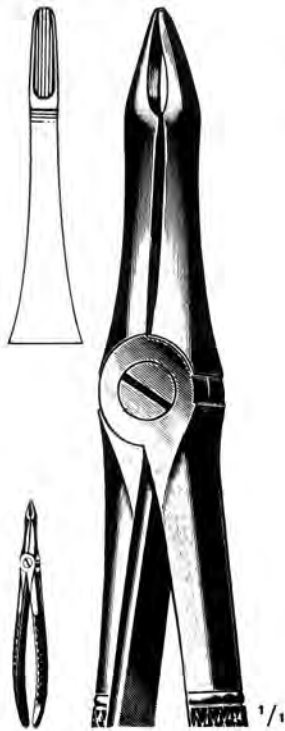
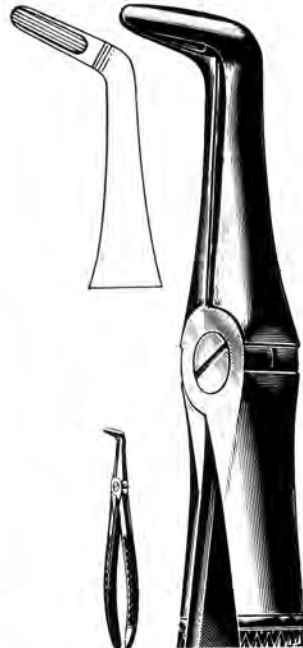

Fig. 41  
60.041.00



44  
60.044.00



45  
60.045.00  
60.945.00



51  
60.051.00

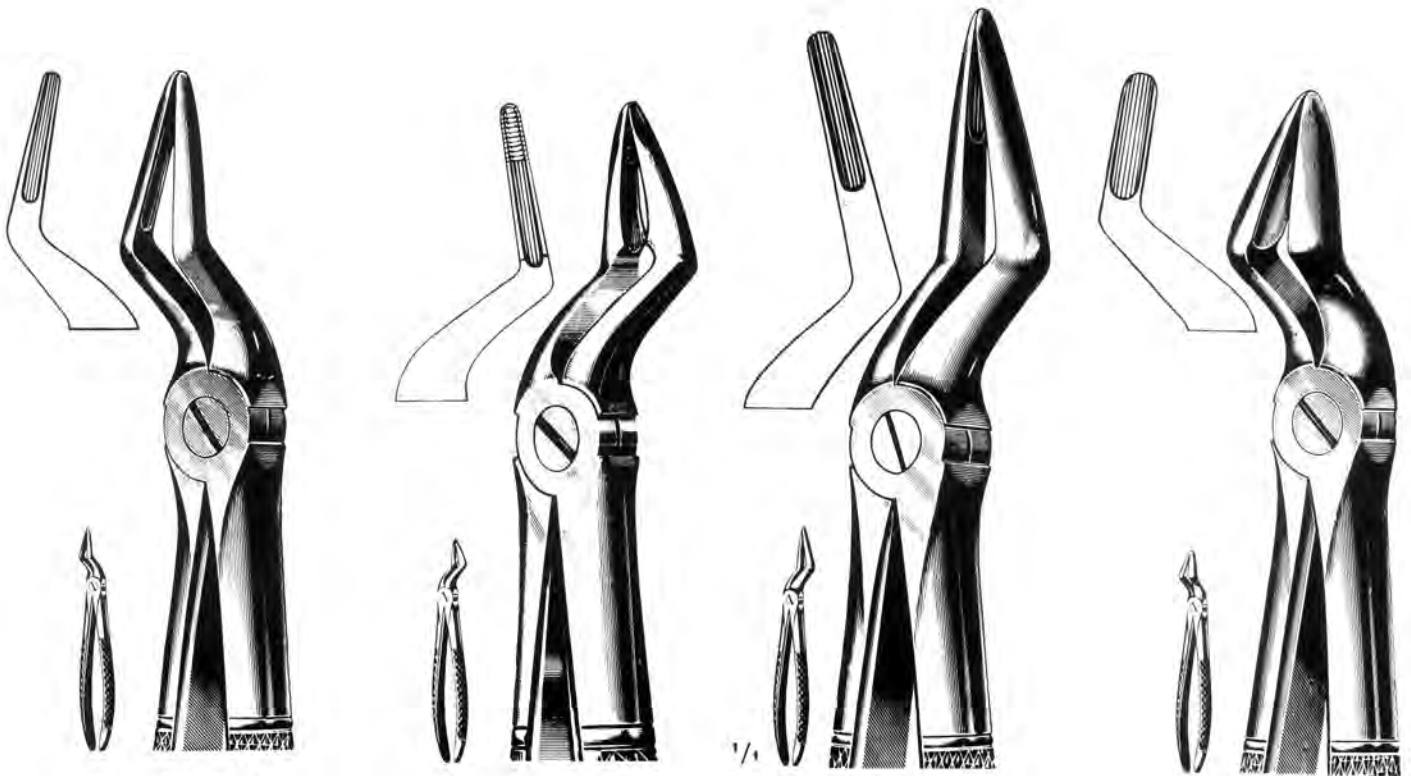

Fig. 51 A  
60.051.01

51 C  
60.051.03  
60.951.03

51 M  
60.051.06

52  
60.052.00

Extracting Forceps  
 Forceps De Extraccion  
 Zahnzangen

English Pattern  
 Forma Inglesa  
 Englische Form



Fig. 52A  
 60.052.01



WITZEL  
 60.053.00

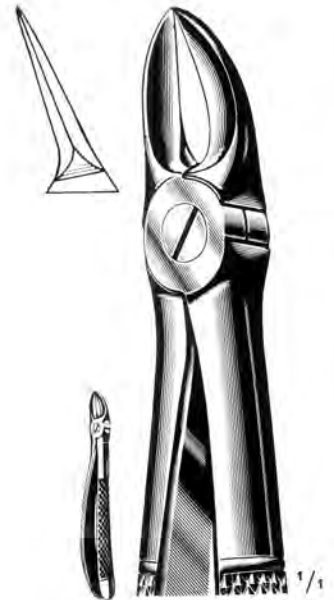

55  
 60.055.00



Fig. 56  
 60.056.00

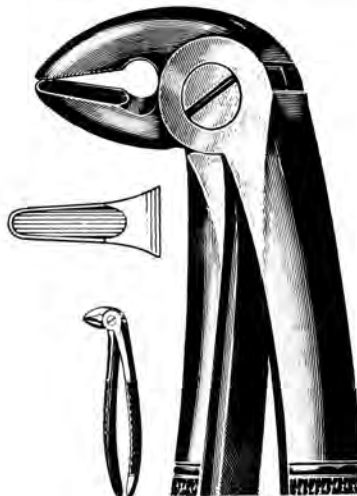

BUSCH  
 60.059.00



BUSCH  
 60.060.00



Fig. 67  
60.067.00

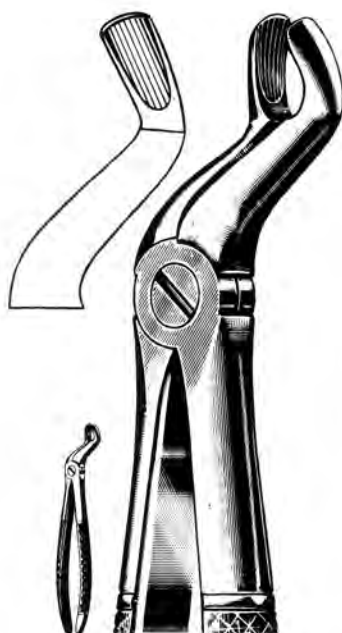

67 A  
60.067.01  
60.967.01



73  
60.073.00



74  
60.074.00



Fig. 74M  
60.074.06

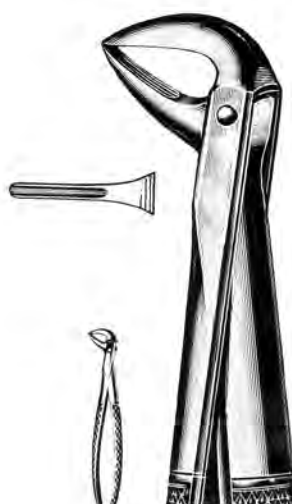

74N  
60.074.07



75  
60..075.00



Fig. 76  
 LAWRENCE READ  
 60.076.00

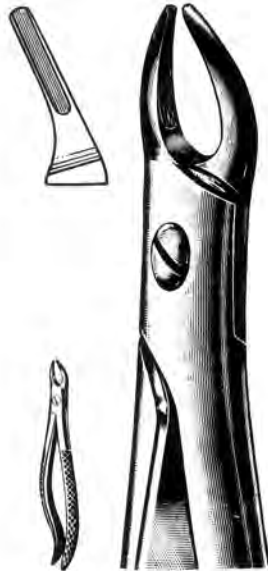

76 N  
 LAWRENCE READ  
 60.076.07



79  
 60.079.00

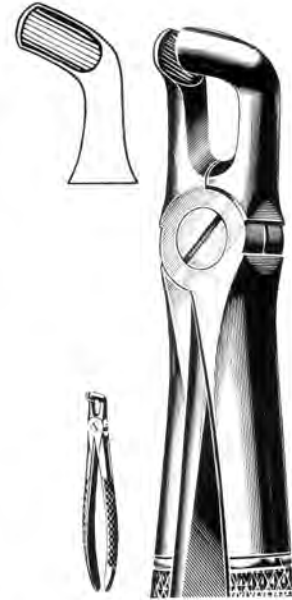

79 A  
 60.079.01



Fig. 86A  
 60.086.01



86 B  
 60.086.02



86 C  
 60.086.03



87  
 60.087.00

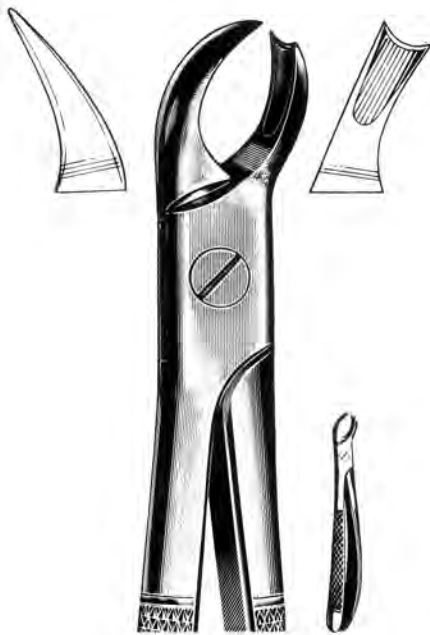
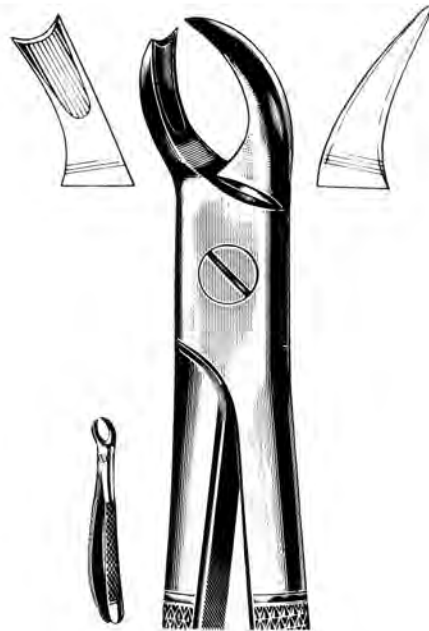

Fig. 89  
60.089.00



90  
60.090.00



94  
60.094.00

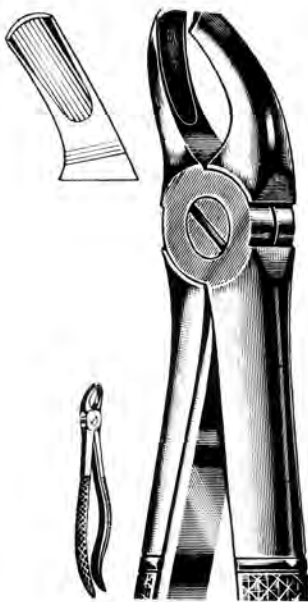

Fig. 95  
60.095.00



99  
PASSO  
60.099.00



99 1/4  
PASSO  
60.099.14

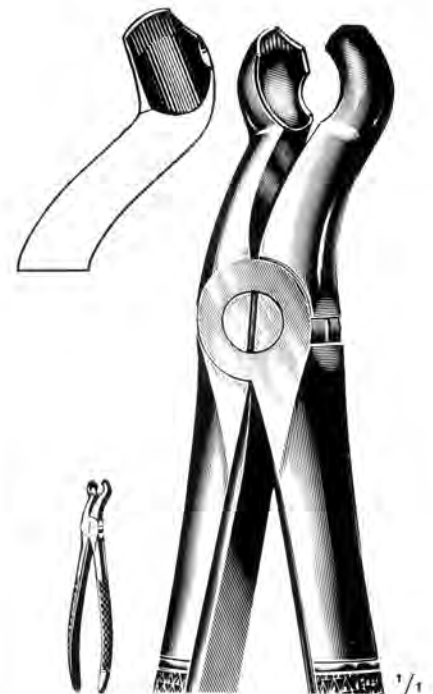

121  
OGDEN-FELSCH  
60.121.00



Extracting Forceps  
 Forceps De Extraccion  
 Zahnzangen

English Pattern  
 Forma Inglesa  
 Englische Form



Fig.136  
 GUY  
 60.136.00



137  
 GUY  
 60.137.00

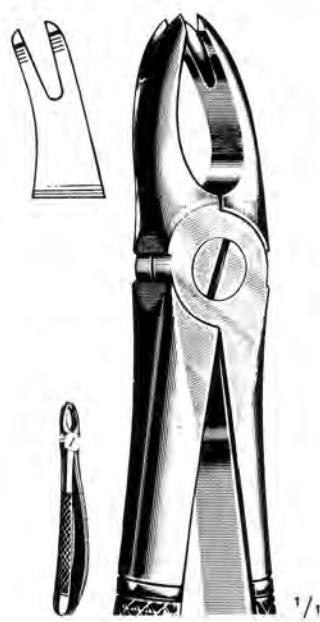

166  
 TROTTER  
 60.166.00

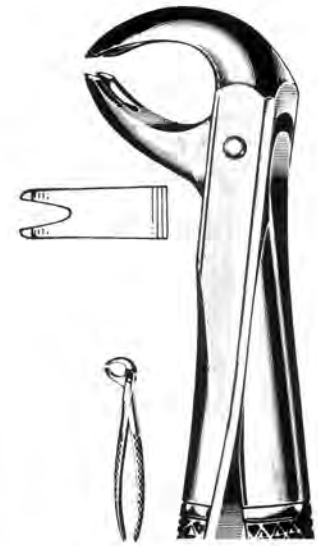

167  
 TROTTER  
 60.167.00



Fig. 168  
 TROTTER  
 60.168.00

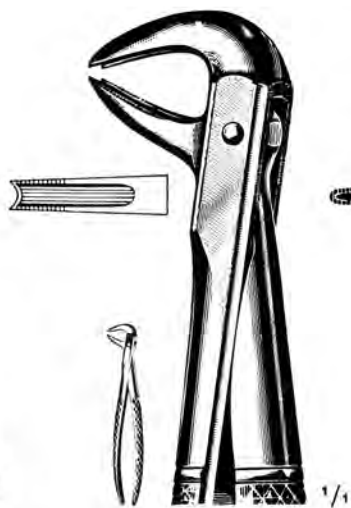

169  
 TROTTER  
 60.169.00



233  
 60.233.00



235  
 60.235.00



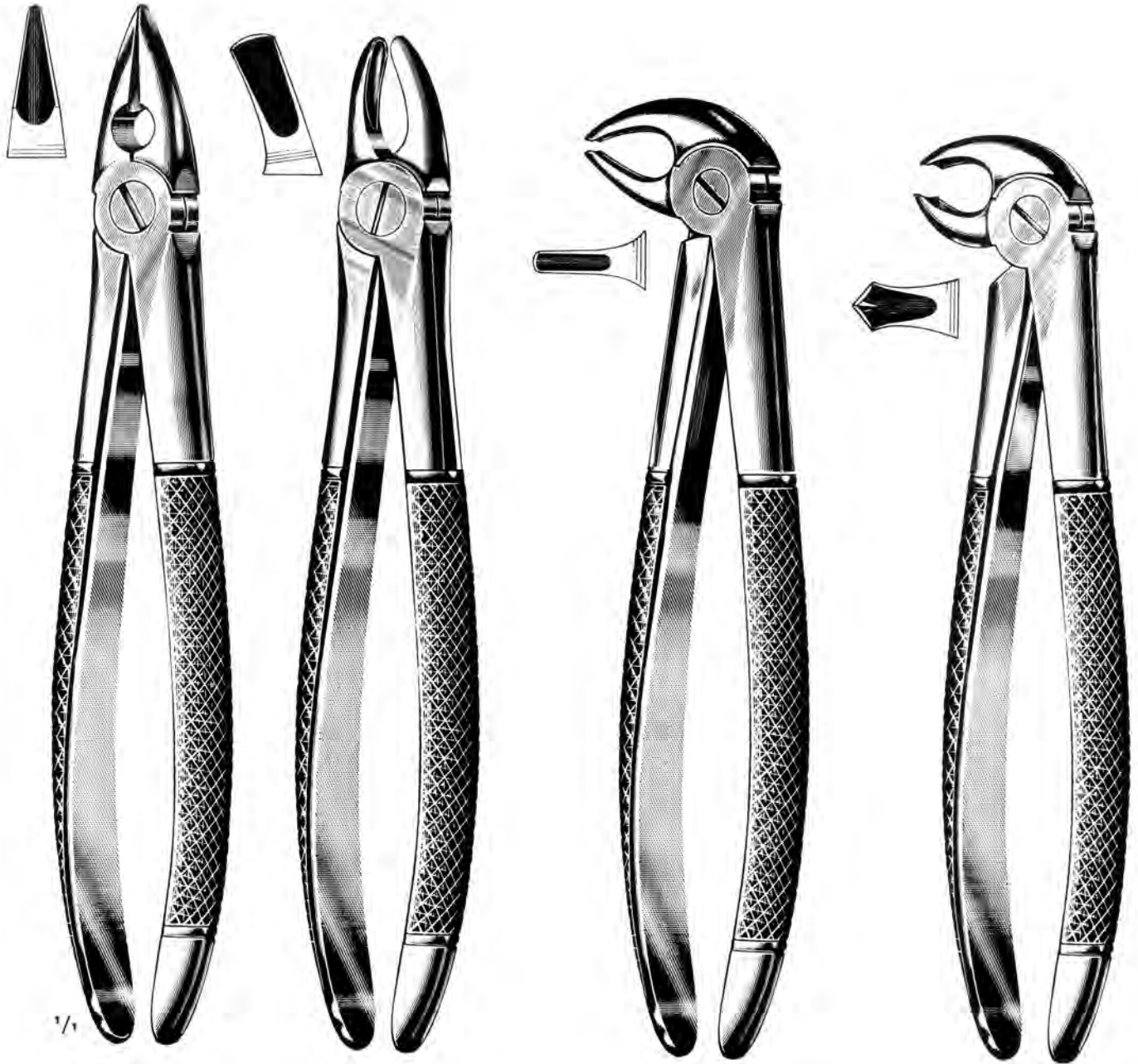

1/1

Fig. MD 1  
MEAD  
60.381.00

MD 2  
MEAD  
60.382.00

MD 3  
MEAD  
60.383.00

MD 4  
MEAD  
60.384.00

Extracting Forceps  
Forceps De Extracción  
Zahnzangen

Universal Pattern  
Modelos Universales  
Universal Modelle



COHEN  
60.401.00



COHEN  
60.402.00



STIKSA  
60.411.00



STIKSA  
60.412.00

Extracting Forceps  
 Forceps De Extraccion  
 Zahnzangen

Wisdom Teeth  
 Para Cordales  
 Weisheits



WISDOM-ROUTURIER  
 60.422.05  
 22½ L

WISDOM-ROUTURIER  
 60.422.08  
 22½ R



Fig. 13 S  
 60.613.09



22 S  
 60.622.09



29 S  
 60.629.09

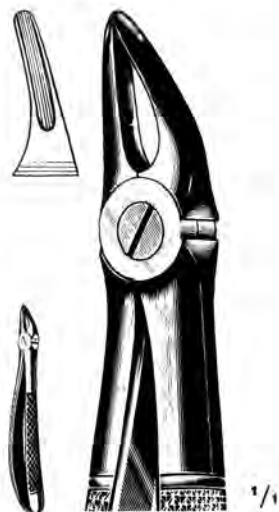

Fig. 30 S  
 60.630.09



33 S  
 60.633.09



Fig. 37  
 60.637.09



Fig. 38  
60.638.00



39  
60.639.00



39 A  
60.639.01



39 L  
60.639.05

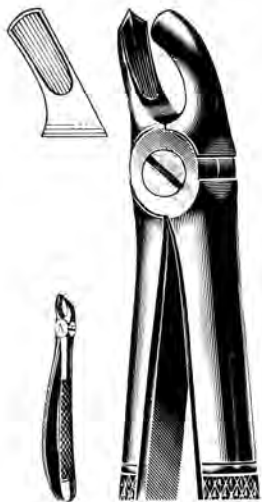

Fig. 39 R  
60.639.00



Fig. 40  
60.640.00



51 S  
60.651.09



76 S  
LAWRENCE READ  
60.676.09

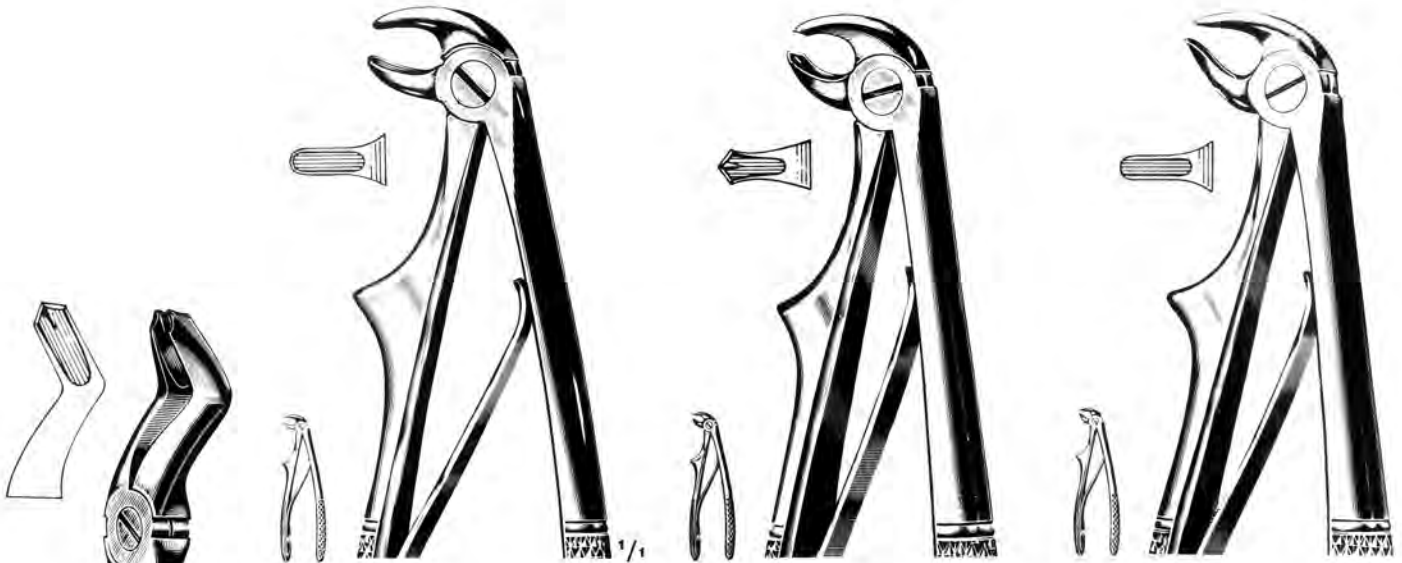

Fig. 5  
 KLEIN  
 60.705.00

6  
 KLEIN  
 60.706.00

7  
 KLEIN  
 60.707.00

Fig. 3  
 KLEIN  
 60.703.00

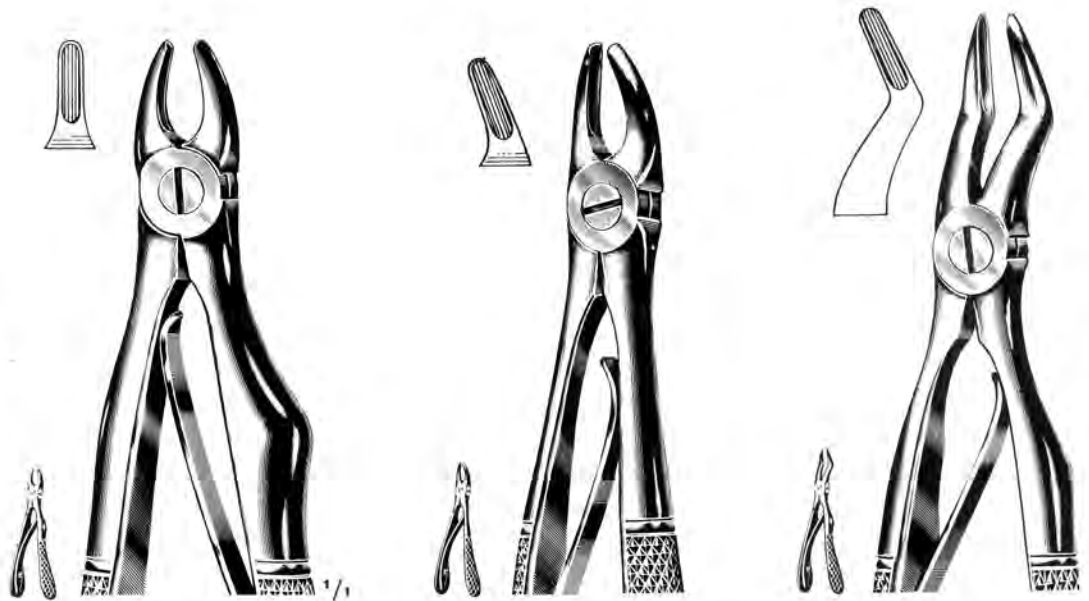

Fig. 137  
 KLEIN  
 60.137.00

139  
 KLEIN  
 60.139.00

51 S  
 KLEIN  
 60.751.00





Fig. 17 SK  
61.017.92

23 SK  
61.023.92

150 SK  
61.150.92

151 SK  
61.151.92

Extracting Forceps  
 Forceps De Extraccion  
 Zahnzangen

American Pattern  
 Forma Americano  
 Amerikansche Form

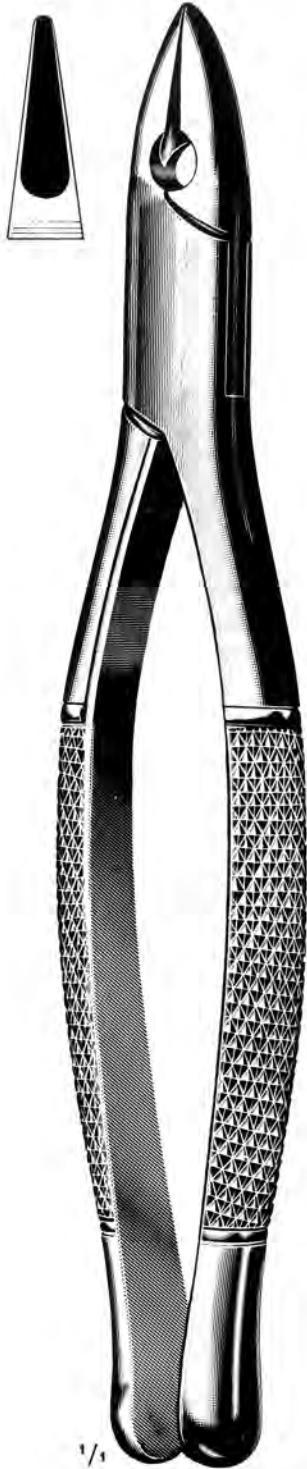
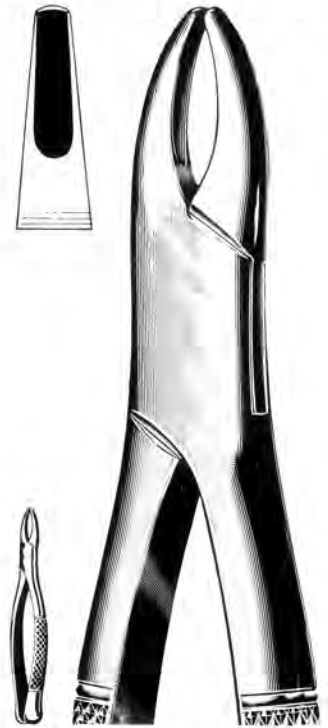

Fig. 1  
**STANDARD**  
 61.001.00



Fig. 1 A  
**HENAKAK**  
 61.001.01



1 B  
**NORMAL**  
 61.001.02



3  
**MILWAUKEE**  
 61.003.00

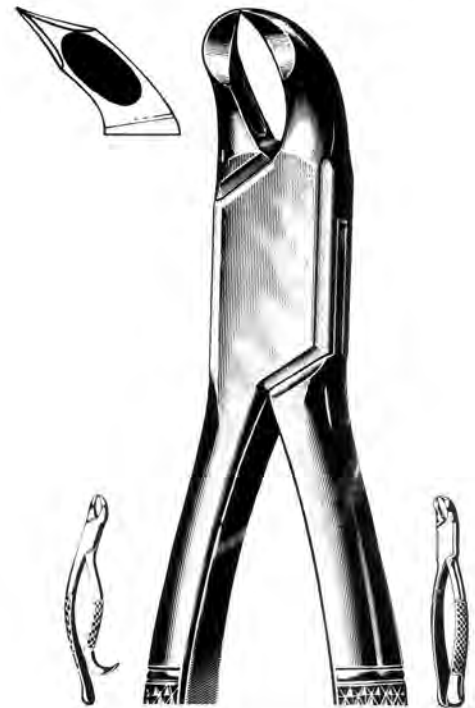

3 FH      3 FS  
**WOODWARD**  
 61.003.04    61.003.09



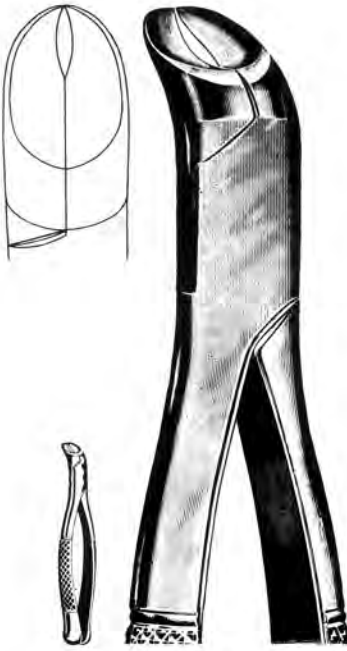
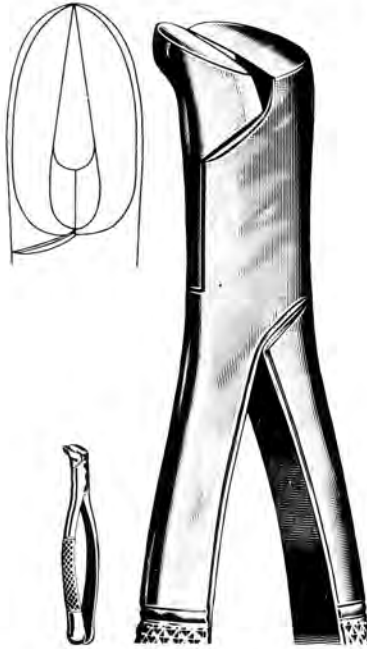
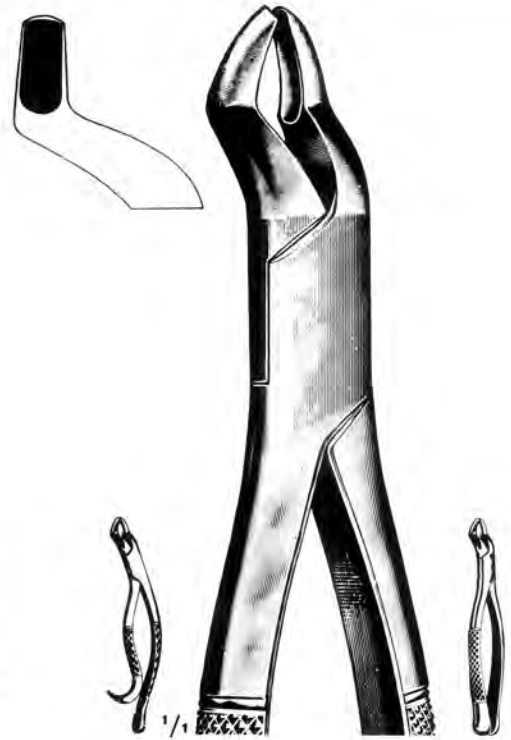

Fig. 5  
PHYSICK  
61.005.00



6  
61.006.00



10H 10 S  
61.010.04 61.010.09



Fig. 15  
HARRIS  
61.015.00



16  
61.016.00

Extracting Forceps  
Forceps De Extraccion  
Zahnzangen

American Pattern  
Forma Americano  
Amerikansche Form

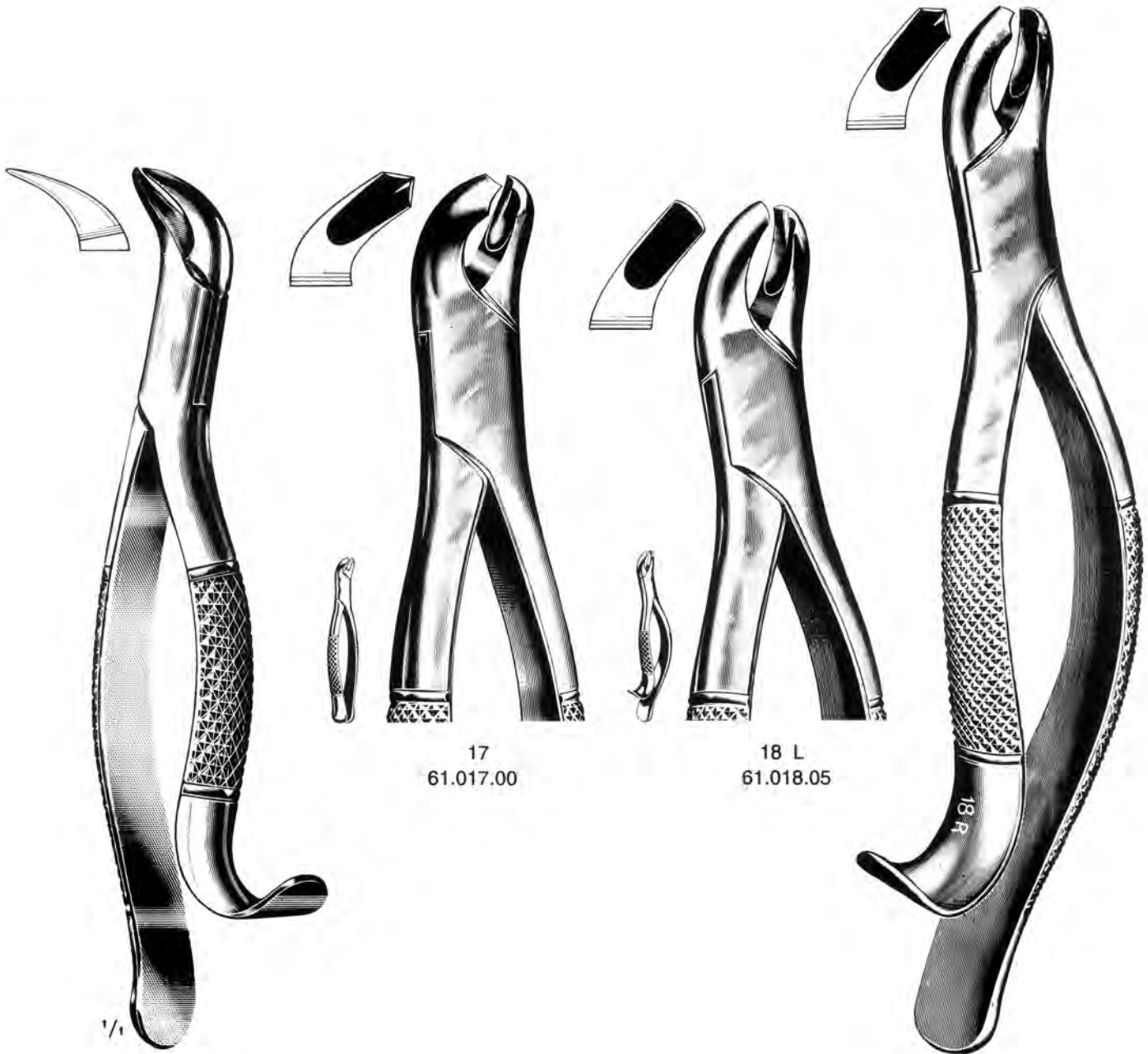

Fig. 16 S  
61.016.09

17  
61.017.00

18 L  
61.018.05

Fig. 18 R  
61.018.08



HILBRO

INSTRUMENTS

Extracting Forceps  
Forceps De Extraccion  
Zahnzangen

American Pattern  
Forma Americano  
Amerikansche Form

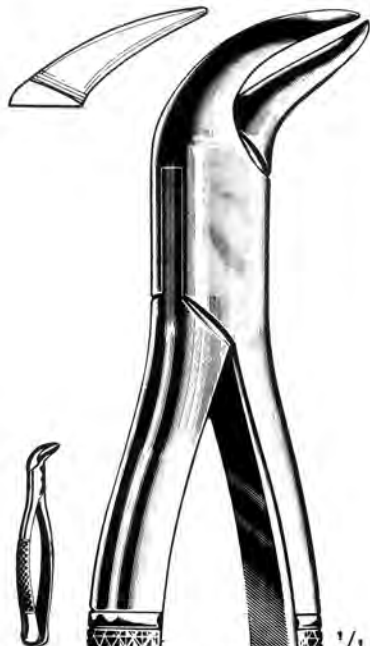

Fig. 23  
61.023.00



24  
61.024.00



32 32 A  
PARMLY  
61.032.00 61.032.01



Fig. 35  
61.035.00

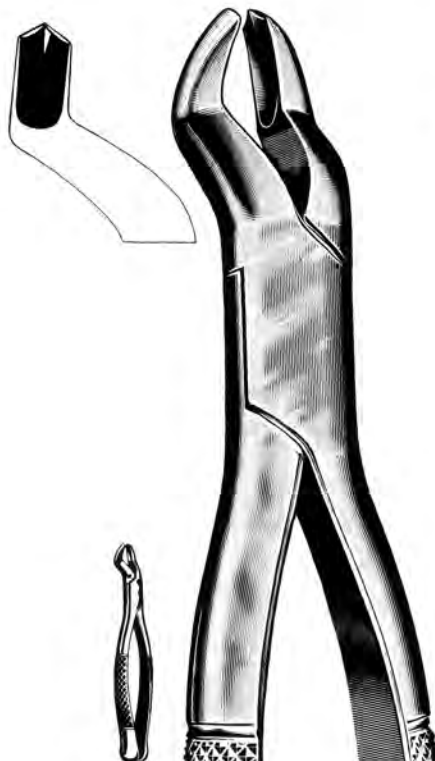

53 L  
61.053.05



53 R  
61.053.08

Extracting Forceps  
 Forceps De Extraccion  
 Zahnzangen

American Pattern  
 Forma Americano  
 Amerikansche Form



Fig. 62  
 61.062.00



Fig. 65  
 61.065.00



69  
 TOMES  
 61.069.00



Fig. 85      85 A  
 THOMAS  
 61.085.00   61.085.01



Fig. 88 L  
NEVIUS  
61.088.05



88 R  
NEVIUS  
61.088.08



Fig. 101  
HULL  
61.101.00

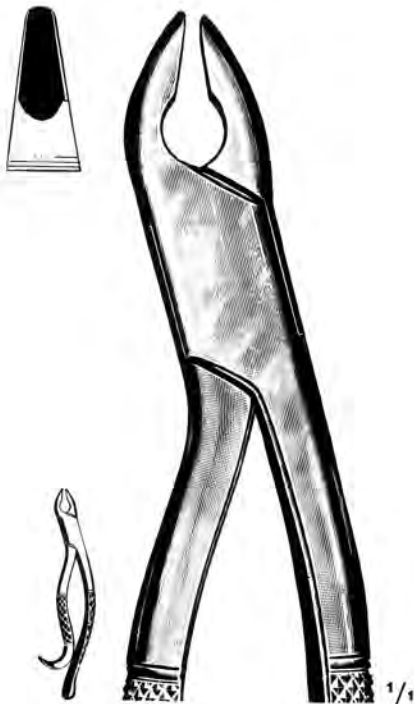

Fig. 99 A  
KELLS  
61.099.01



99 C  
KELLS  
61.099.03



Fig. 103

61.103.00

NEVIUS

61.110.04

61.110.09

121

FELSCH

61.121.00





Fig. 150  
CRYER  
61.150.00

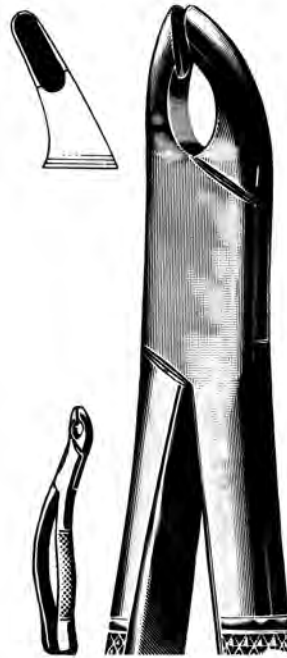

150 A  
CRYER  
61.150.01



150 S  
CRYER  
61.150.09



Fig. 151  
CRYER  
61.151.00



151 A  
CRYER  
61.151.01

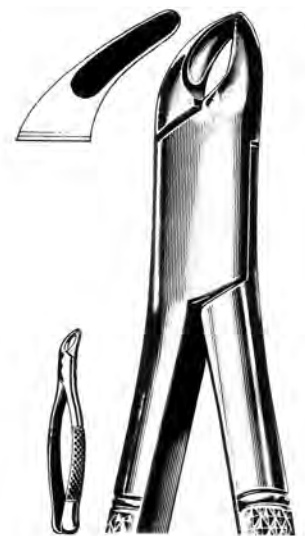

151 S  
CRYER  
61.151.00

Extracting Forceps  
 Forceps De Extraccion  
 Zahnzangen

American Pattern  
 Forma Americano  
 Amerikansche Form

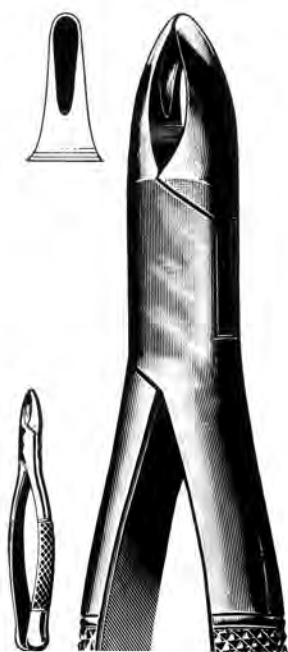

Fig. 201  
 61.201.00



203  
 61.203.01

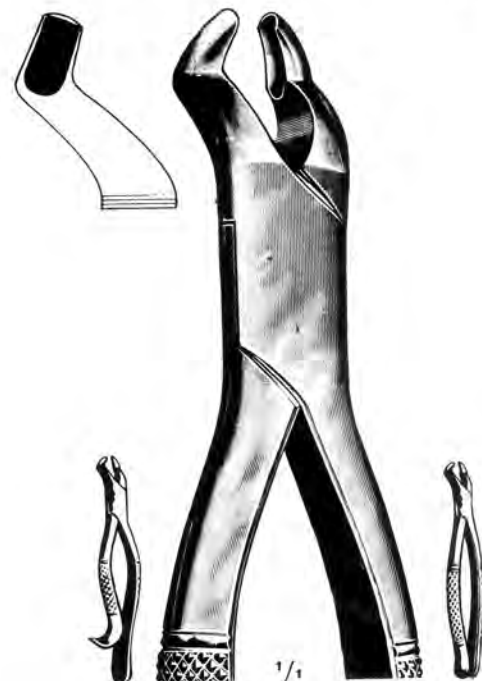

Fig 210 H  
 61.210.04

210 S  
 61.210.09



Fig. 217  
 61.217.00



222  
 61.222.00





Fig 286  
61.286.00



Fig 287  
SWING  
61.287.00



288  
61.288.00

Root Fragment Forceps  
Forceps Para Fragmentos De Racias  
Wurzelsplitterzangen



WITZEL  
61.501.00

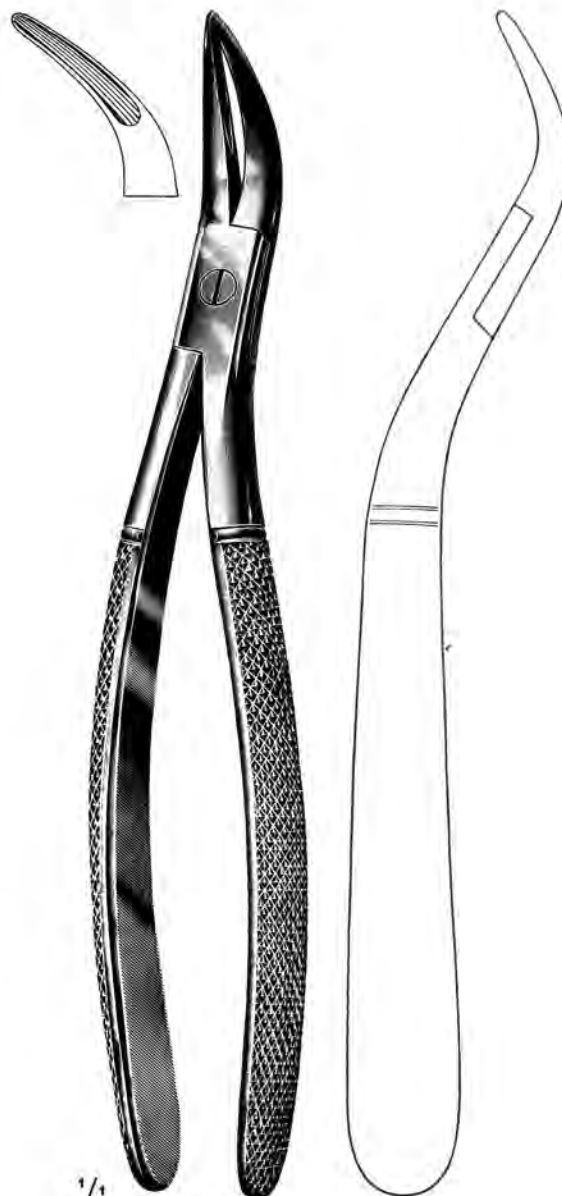

WITZEL  
61.502.00



Fig. 1B  
62.501.01  
to  
62.605.02



Fig. 1B  
62.801.01  
to  
62.905.02



Fig. 1 B



Fig. 2 B  
BEIN  
62.501.01  
62.801.01



3 B  
BEIN  
62.501.02  
62.801.02



4 B  
BEIN  
62.501.03  
62.801.03



5 B  
BEIN  
62.501.04  
62.801.04



6 B  
BEIN  
62.501.05  
62.801.05



F 1  
FLOHR  
62.510.01  
62.810.01



F 2  
FLOHR  
62.511.01  
62.811.01



F 3  
FLOHR  
62.511.02  
62.811.02



4 SA  
SCHMECKEBIER  
APEXO  
62.512.01  
62.812.01



5 SA  
SCHMECKEBIER  
APEXO  
62.512.02  
62.812.02



Fig. 71  
MILLER APEXO  
62.520.01  
62.820.01



Fig. 72  
MILLER APEXO  
62.520.02  
62.820.02



73  
MILLER APEXO  
62.520.03  
62.820.03



74  
MILLER APEXO  
62.520.04  
62.820.04



19  
MILLER APEXO  
62.520.05  
62.820.05



20  
MILLER APEXO  
62.520.06  
62.820.06



Fig. 34 S  
SELDIN  
62.525.01  
62.825.01



34  
SELDIN  
62.525.02  
62.825.02



2 S  
SELDIN  
62.525.03  
62.825.03



3 S  
SELDIN  
62.525.04  
62.825.04



Fig. 1L  
 SELDIN  
 62.530.01  
 62.830.01



Fig. 1R  
 SELDIN  
 62.530.02  
 62.830.02



4L  
 SELDIN  
 62.530.03  
 62.830.03



4R  
 SELDIN  
 62.530.04  
 62.830.04



51  
 CURTIN  
 62.535.01  
 62.835.01



52  
 CURTIN  
 62.535.02  
 62.835.02



Fig. 11  
 STOUT  
 62.540.01  
 62.840.01



11A  
 STOUT  
 62.540.02  
 62.840.02



44 C  
 BRADC  
 62.545.01  
 62.845.01



12  
 62.545.02  
 62.845.02



Fig. A  
COGSWELL  
62.550.01  
62.850.01



Fig. B  
COGSWELL  
62.850.02  
62.550.02



301  
APEXO  
62.855.01  
62.555.01



302  
APEXO  
62.855.02  
62.555.02



303  
APEXO  
62.855.03  
62.555.03



301 W  
SELDIN  
62.860.01  
62.560.01



304 W  
SELDIN  
62.860.02  
62.560.02



Fig 1H  
HEIDBRINK  
62.560.03  
62.860.03



2H  
HEIDBRINK  
62.560.04  
62.860.04



40H  
HEIDBRINK  
62.560.05  
62.860.05



41H  
HEIDBRINK  
62.560.06  
62.860.06



46  
HEIDBRINK  
62.560.07  
62.860.07



46R  
HEIDBRINK  
62.560.08  
62.860.05





Fig. 44  
 CRYER  
 62.565.01  
 62.865.01



Fig. 45  
 CRYER  
 62.565.02  
 62.865.02



25  
 CRYER  
 62.565.03  
 62.865.03



26  
 CRYER  
 62.565.04  
 62.865.04



31  
 CRYER  
 62.565.05  
 62.865.05



32  
 CRYER  
 62.565.06  
 62.865.06



Fig. 80  
 62.565.07  
 62.865.07



81  
 62.565.08  
 62.865.08



81A  
 62.565.09  
 62.865.09



81E  
 62.565.10  
 62.865.10



Fig. A1C  
COUPLAND  
62.570.01  
62.870.01



Fig. A2C  
COUPLAND  
62.570.02  
62.870.02



A3C  
COUPLAND  
62.570.03  
62.870.03



15  
WOODWARD  
62.575.01  
62.875.01



16  
WOODWARD  
62.575.02  
62.875.02



Fig. 190  
WOODWARD  
62.575.03  
62.875.03



191  
WOODWARD  
62.575.04  
62.875.04



23  
62.575.05  
62.875.05



24  
62.575.06  
62.875.06



98  
62.575.07  
62.875.07



**Fig. 1C**  
**COUPLAND**  
 62.580.01  
 62.880.01



**Fig. 2C**  
**COUPLAND**  
 62.580.02  
 62.880.02



**3C**  
**COUPLAND**  
 62.580.03  
 62.880.03



**11M**  
**MACMILLAN**  
 62.585.01  
 62.885.01



**12M**  
**MACMILLAN**  
 62.585.02  
 62.885.02



**13M**  
**MACMILLAN**  
 62.585.03  
 62.885.03



**Fig. 8**  
**CRANE**  
 62.590.01  
 62.890.01



**Fig. 21**  
**UNIVERSITY OF MICHIGAN**  
 62.595.01  
 62.895.01



**69 W**  
**WOODWARD**  
 62.600.01  
 62.900.01



**31F**  
**FRIEDMAN**  
 62.605.01  
 62.905.01



**32F**  
**FRIEDMAN**  
 62.605.02  
 62.905.02



Fig. 1  
FLOHR  
62.610.01



2  
FLOHR  
62.610.02



3  
FLOHR  
62.610.03



Fig. 7  
CRYER  
62.615.01



8  
CRYER  
62.615.02



Fig. 1  
BEIN  
62.620.01



2  
62.620.02



3  
62.625.03



2  
62.625.02



3  
62.625.03



4.5mm  
Fig. 1  
HYLIN  
62.630.01



3mm  
Fig. 2  
62.630.02



3mm  
Fig. 3  
62.630.03



3mm  
Fig. 4  
62.630.04



COLEMAN  
62.640.01



LONDON  
HOSPITAL  
62.640.02



LONDON  
HOSPITAL  
62.640.03

Root Elevators  
Elevadores Para raices  
Wurzelheber

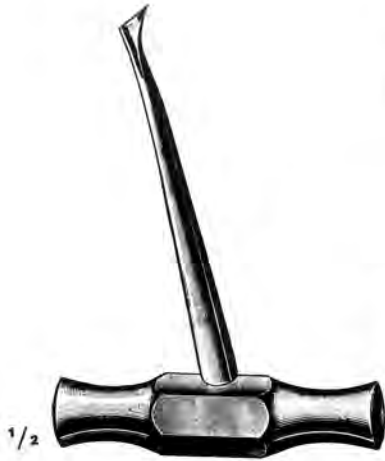

WALTER F BARRY  
62.660.20 62.660.71



Fig. 320 321  
62.660.20 62.660.21



322 323  
62.660.22 62.660.23



370 371  
62.660.70 62.660.71

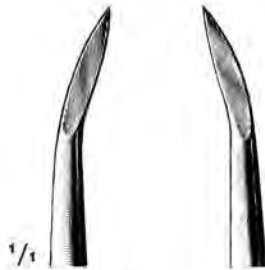

Fig. 1L 1R  
62.665.01 62.665.02



11L 11R  
62.666.01 62.666.02



12L 12R  
62.667.01 62.667.02

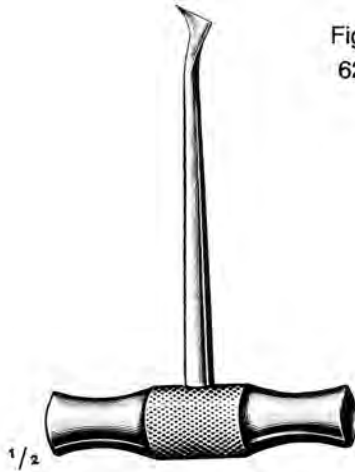

WINTER  
62.665.01  
to  
62.669.02



Fig. 13L 13R  
62.668.01 62.668.02



14L 14R  
62.669.01 62.669.02



**LECLUSE**  
 62.670.01 62.670.02

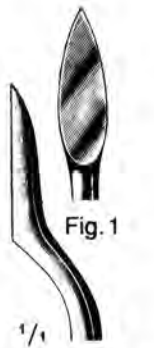

62.670.01



62.670.02



**LECLUSE**  
 62.671.01 62.671.02



**LOOS**  
 62.675.01 62.675.06



62.675.01



62.675.02



62.675.05



62.675.06



**POTT**  
 62.680.01  
 62.680.02



62.680.01



62.680.02



Root Elevators  
Elevadores Para raices  
Wurzelheber



Fig. 1  
WARWICK-JAMES  
62.685.01

2  
62.685.02

3  
62.685.03



FLOHR

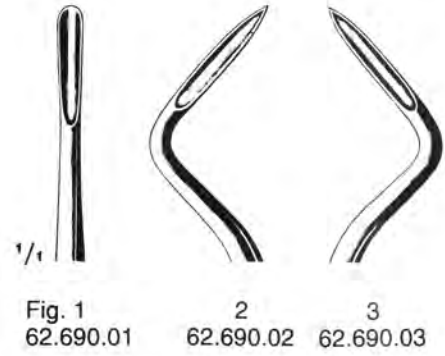

Fig. 1  
62.690.01

2  
62.690.02

3  
62.690.03



FRIEDMAN

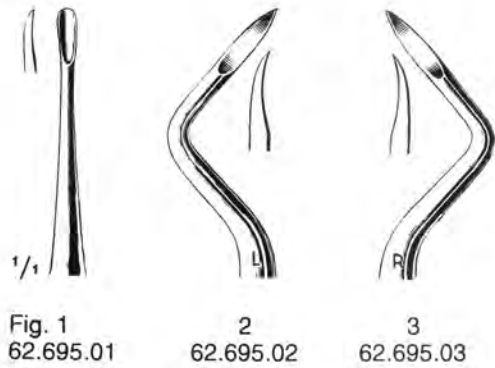

Fig. 1  
62.695.01

2  
62.695.02

3  
62.695.03

Injection Syringes  
Jeringas para inyecciones  
Injektionsspritzen

Water syringes  
Jeringas para agua  
Wasserspritzen

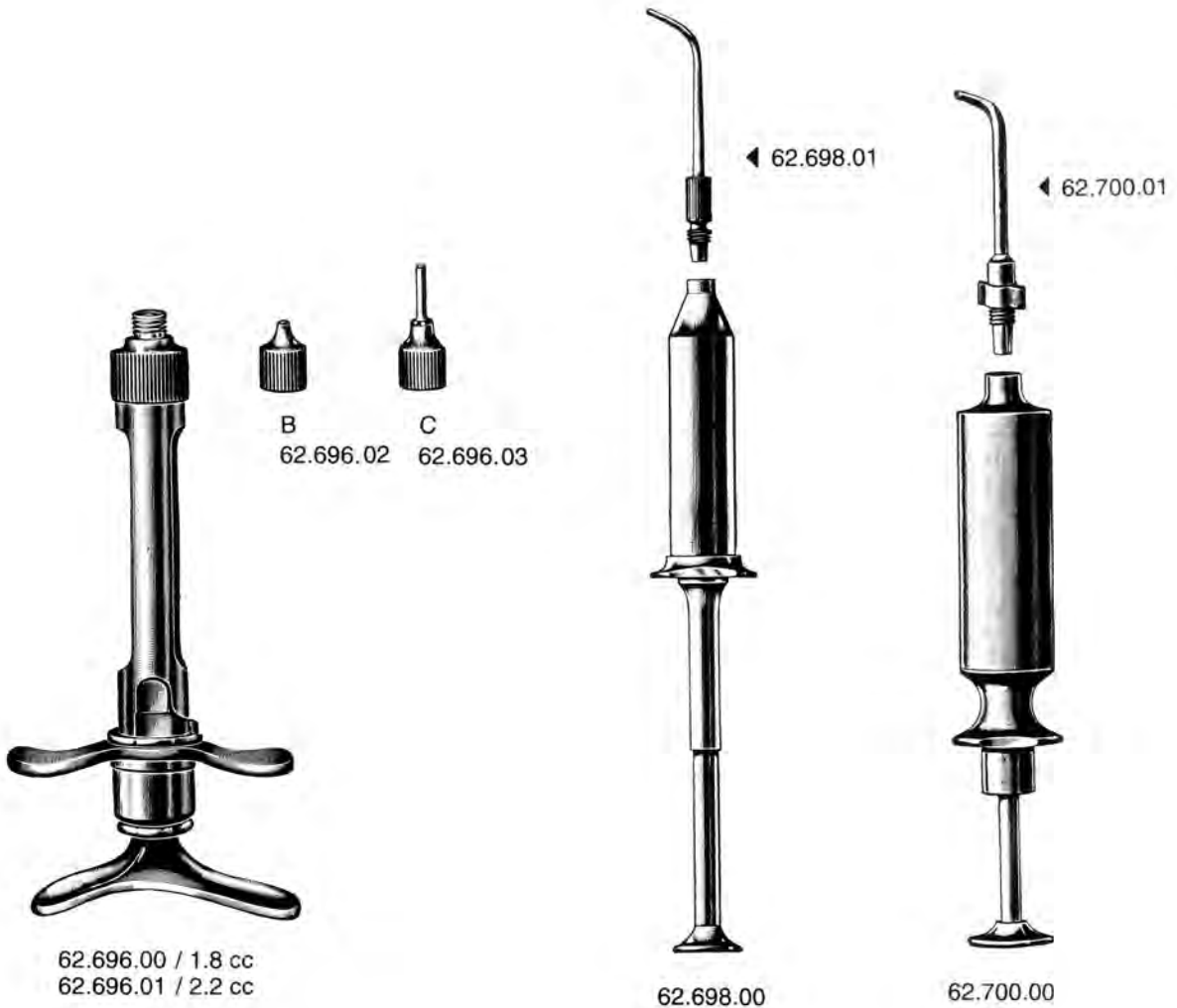



| mmø | Size | Plain     | Magnifying |
|-----|------|-----------|------------|
| 22  | 4    | 62.702.22 | 62.703.22  |
| 24  | 5    | 62.702.24 | 62.703.24  |



62.721.01

62.722.01

62.723.01

62.726.01

62.728.01

62.730.01

Cotton and Dressing Tweezers  
 Pinzas para algodón y curaciones  
 Zahnpinzetten



LONDON COLLEGE  
 15 cm / 6"  
 Fig. 1 63.031.01  
 2 63.031.02  
 3 63.031.03  
 4 63.031.04  
 5 63.031.05  
 6 63.031.06  
 7 63.031.07  
 8 63.031.08

LONDON COLLEGE  
 15 cm / 6"  
 63.033.01  
 63.033.02  
 63.033.03  
 63.033.04  
 63.033.05  
 63.033.06

LONDON COLLEGE  
 15 cm / 6"  
 63.035.01  
 63.035.02  
 63.035.03  
 63.035.04  
 63.035.05  
 63.035.06

LONDON COLLEGE  
 15 cm / 6"  
 63.037.01  
 63.037.02  
 63.037.03  
 63.037.04  
 63.037.05  
 63.037.06  
 63.037.07  
 63.037.08



Fig. 1

2

3

4

5

6

7

8



$\frac{2}{3}$

**MERIAM**  
16 cm / 6¼"

- Fig. 1 63.101.01  
2 63.101.02  
3 63.101.03  
4 63.101.04  
5 63.101.05  
6 63.101.06



**MERIAM**  
16 cm / 6¼"

- 63.103.01  
63.103.02  
63.103.03  
63.103.04  
63.103.05  
63.103.06



**FLAGG**  
16 cm / 6¼"

- 63.107.01  
63.107.02  
63.107.03  
63.107.04



**FLAGG**  
16 cm / 6¼"

- 63.109.01  
63.109.02  
63.109.03  
63.109.04



$\frac{1}{1}$

Fig. 1



2



3



4



5



6

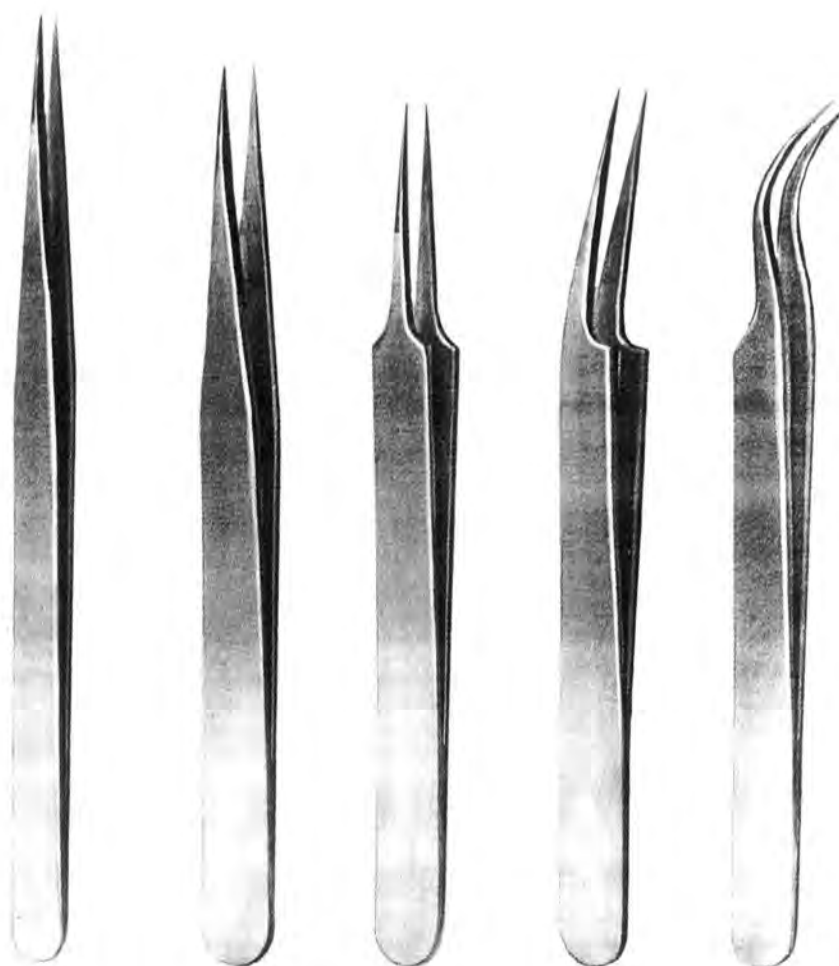

Fig.1  
63.121.12  
12.5 cm / 5"

2  
63.122.12  
12 cm / 4¾"

3  
63.123.11  
11.5 cm / 4½"

4  
63.124.11  
11.5 cm / 4½"

5  
63.125.11  
11.5 cm / 4½"

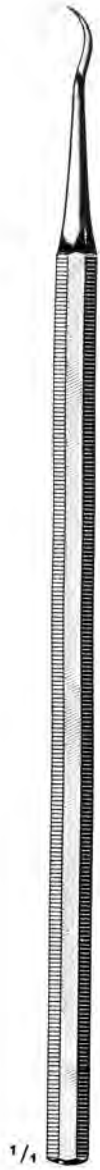

Fig. 1  
63.245.01



2  
63.245.02



3  
63.245.03



4  
63.245.04



6  
63.245.06



7  
63.245.07



Fig. 9  
63.245.09



12  
63.245.12



14  
63.245.14



25  
63.245.25



26  
63.245.26



Fig. 32  
63.245.32



33  
63.245.33



34  
63.245.34



33½  
63.245.35



34½  
63.245.36



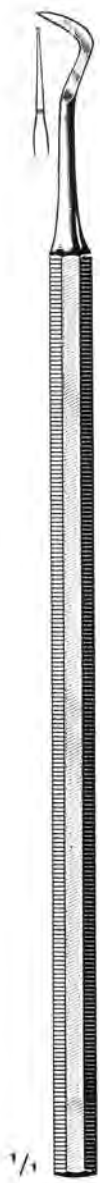
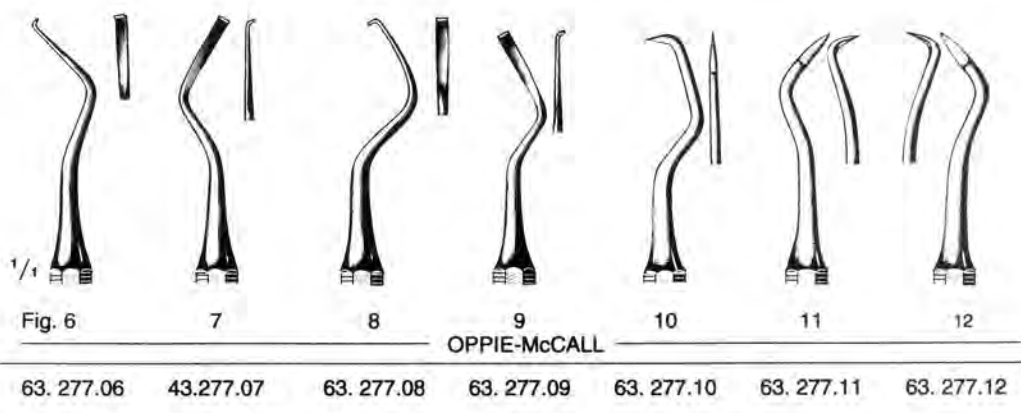
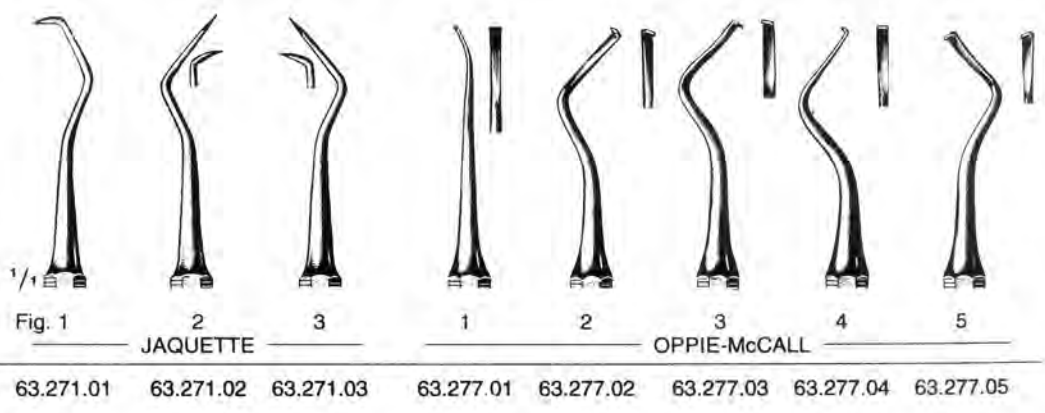
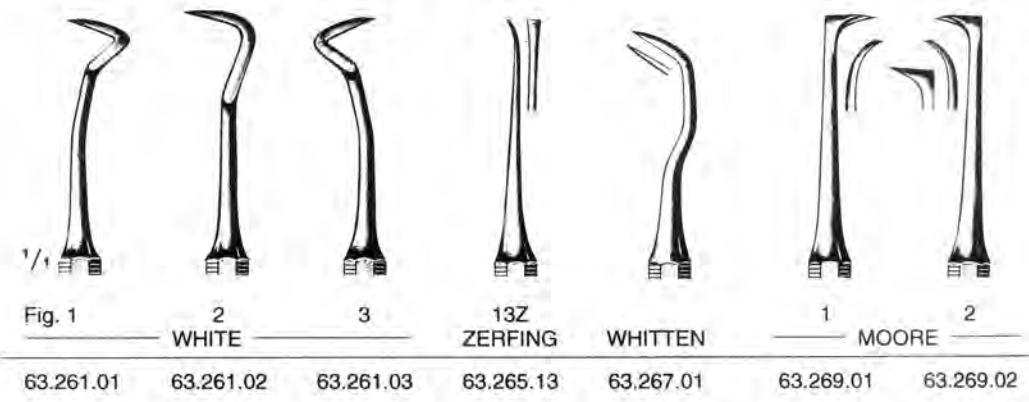
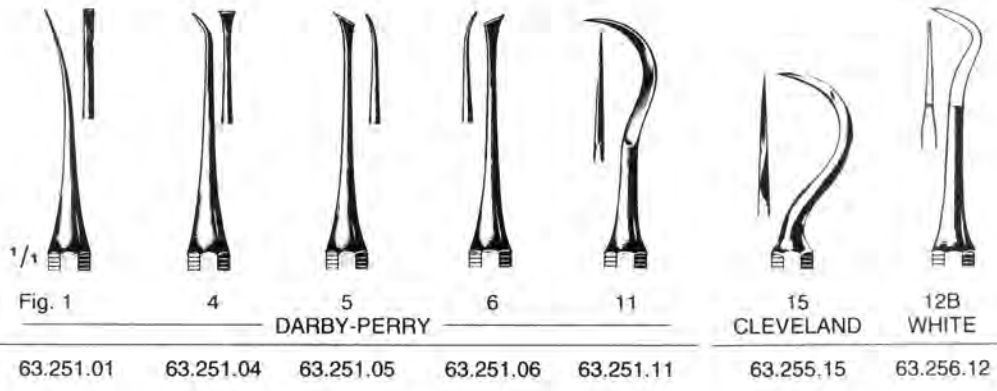

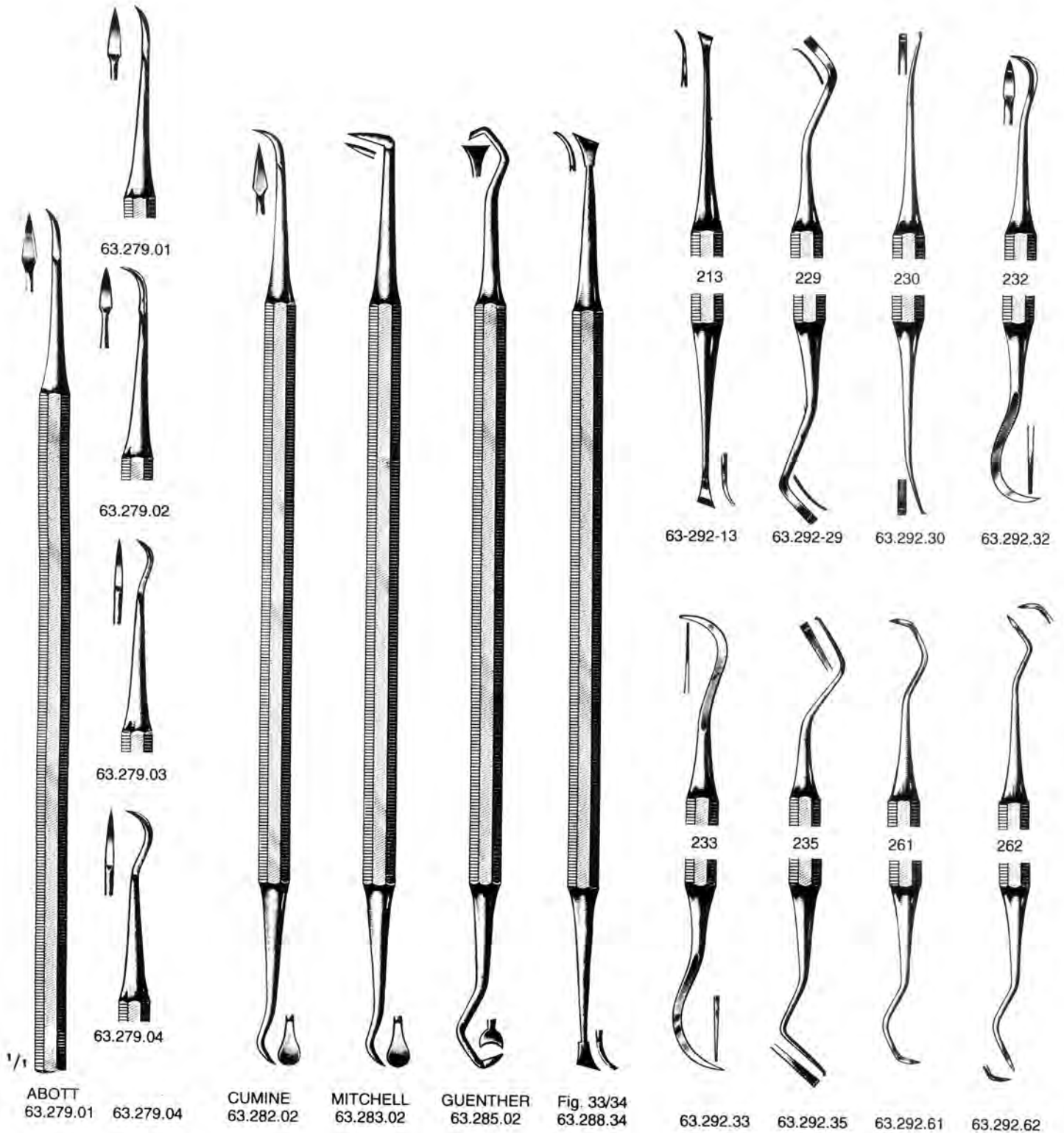

Scalers for Periodontosis and Pyorrhea  
 Limpiadores de sarro para periodontosis y piorrea  
 Reinigungsinstrumente für Parodontose und Pyorrhoe

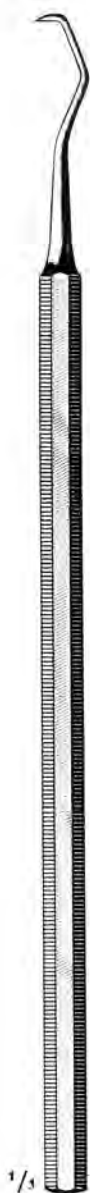
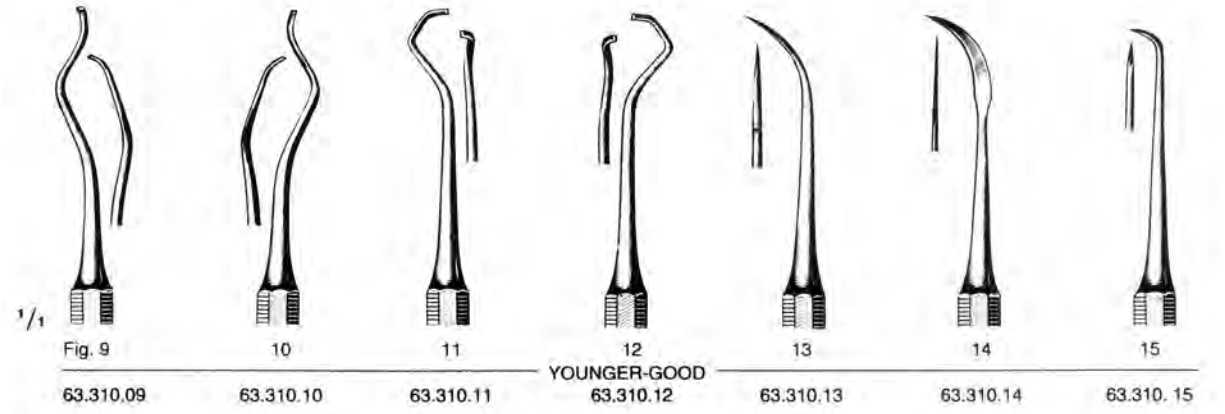
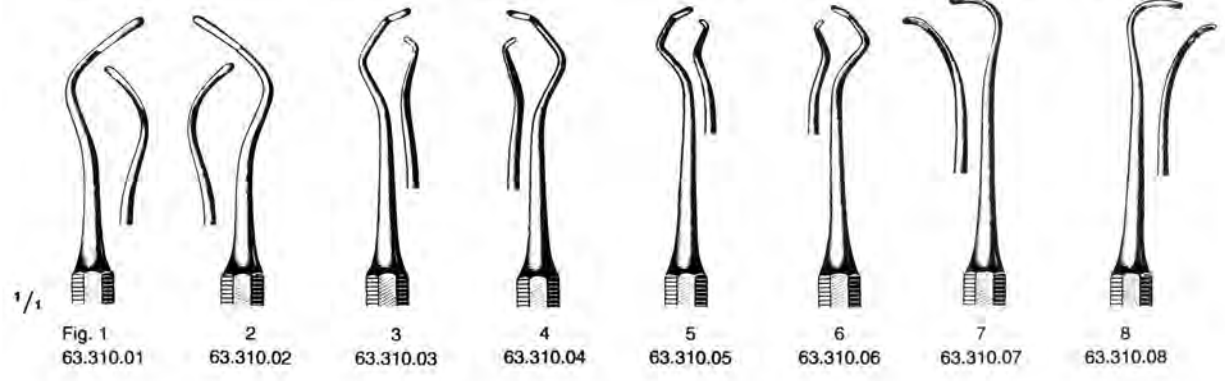
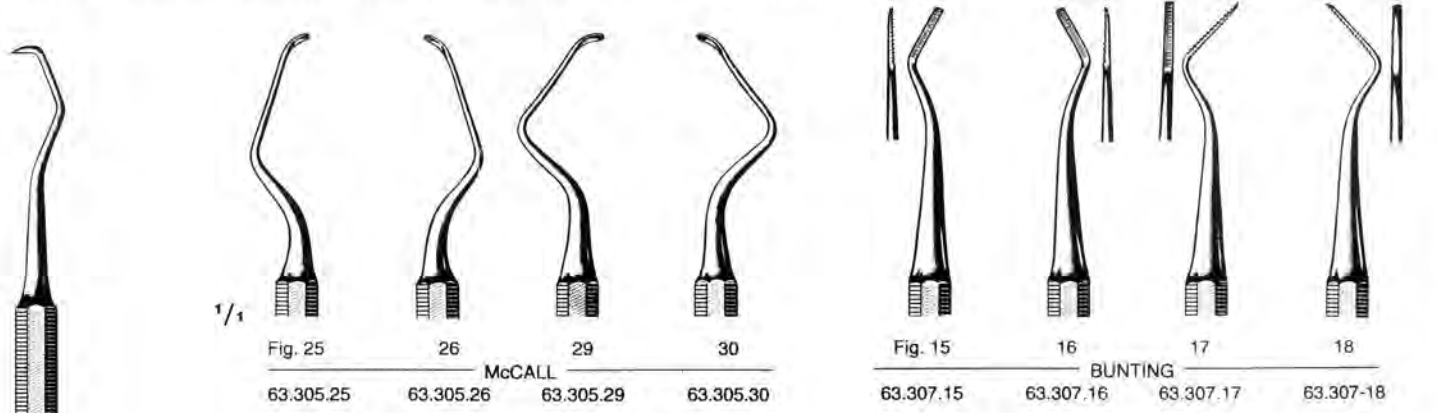
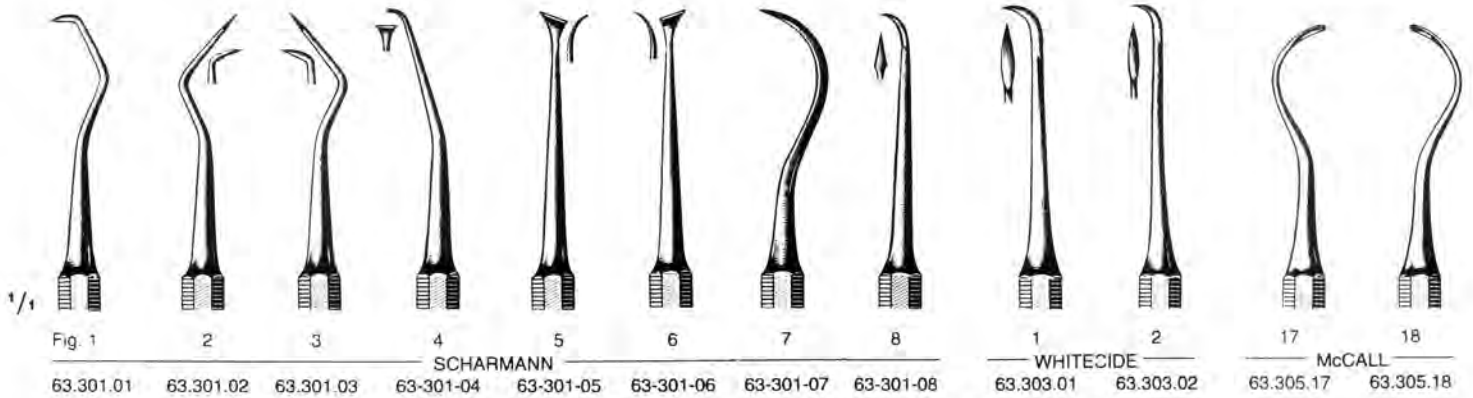

Scalers for Periodontitis and Pyorrhea  
Limpiadores de sarro para periodontitis y piorrea  
Reinigungsinstrumente für Parodontose und Pyorrhoe

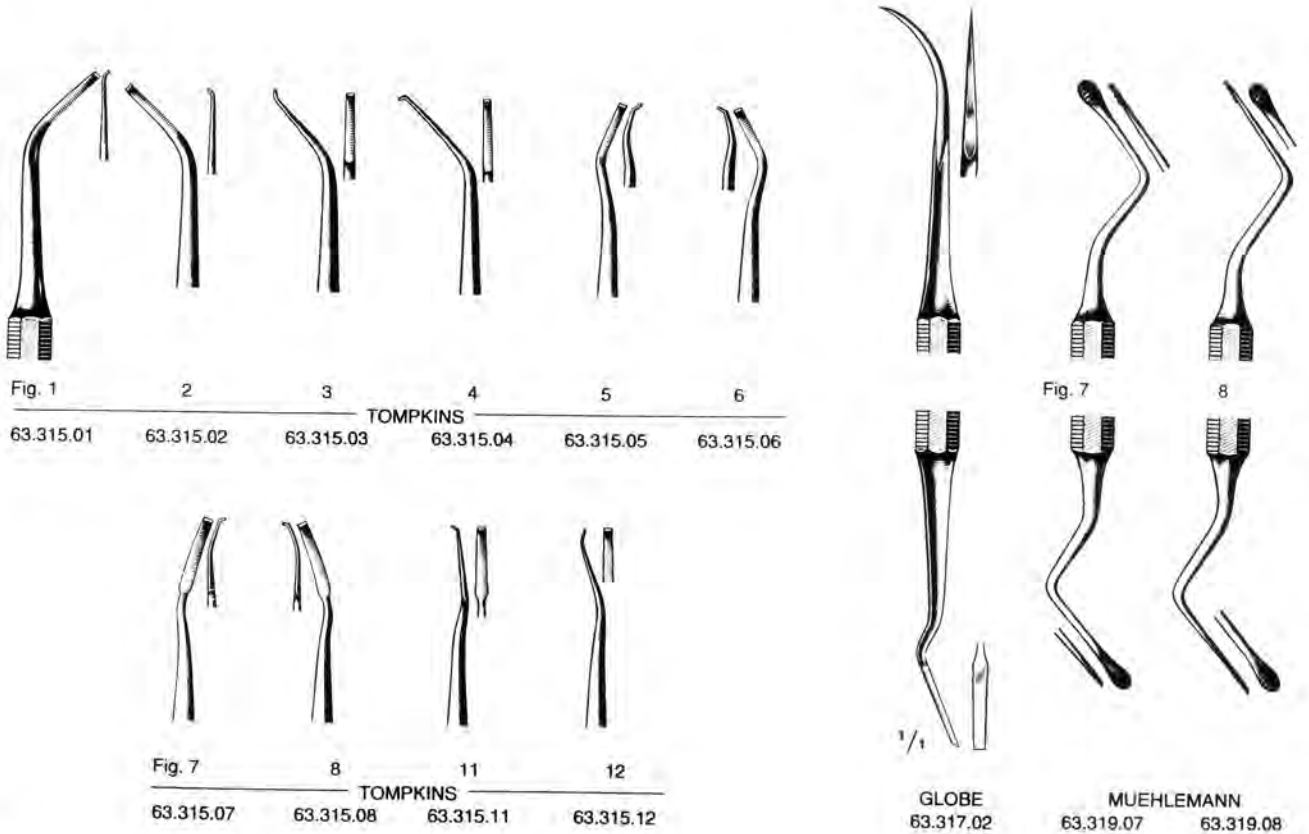
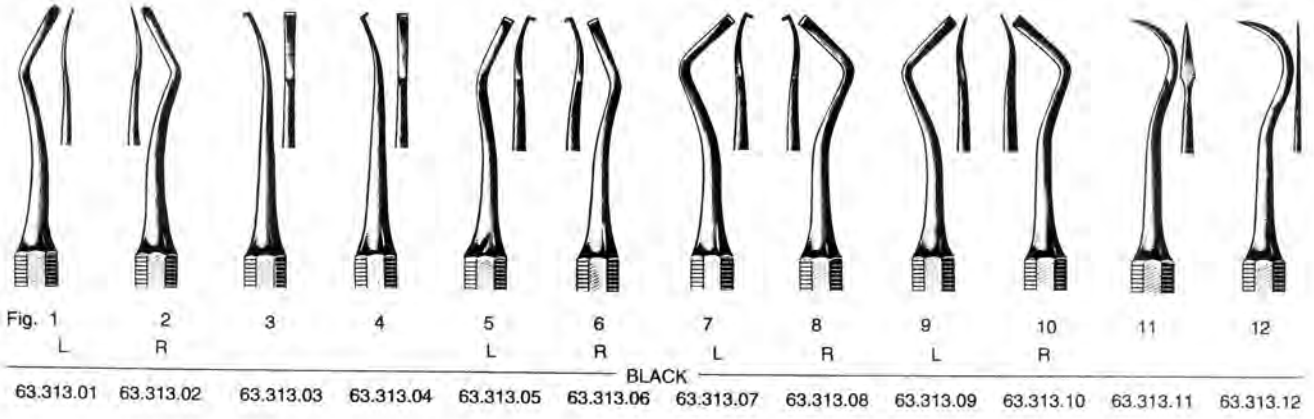

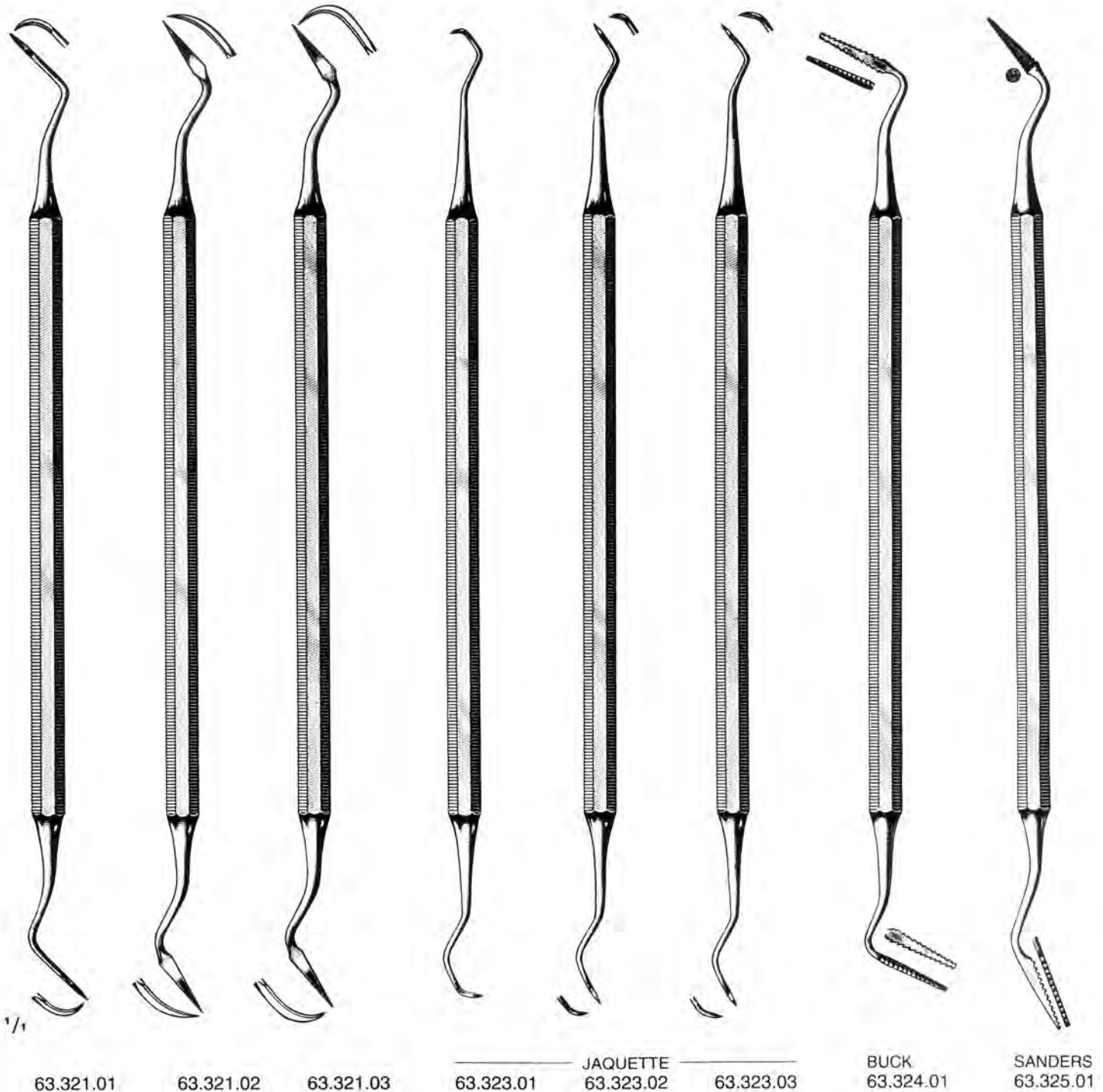

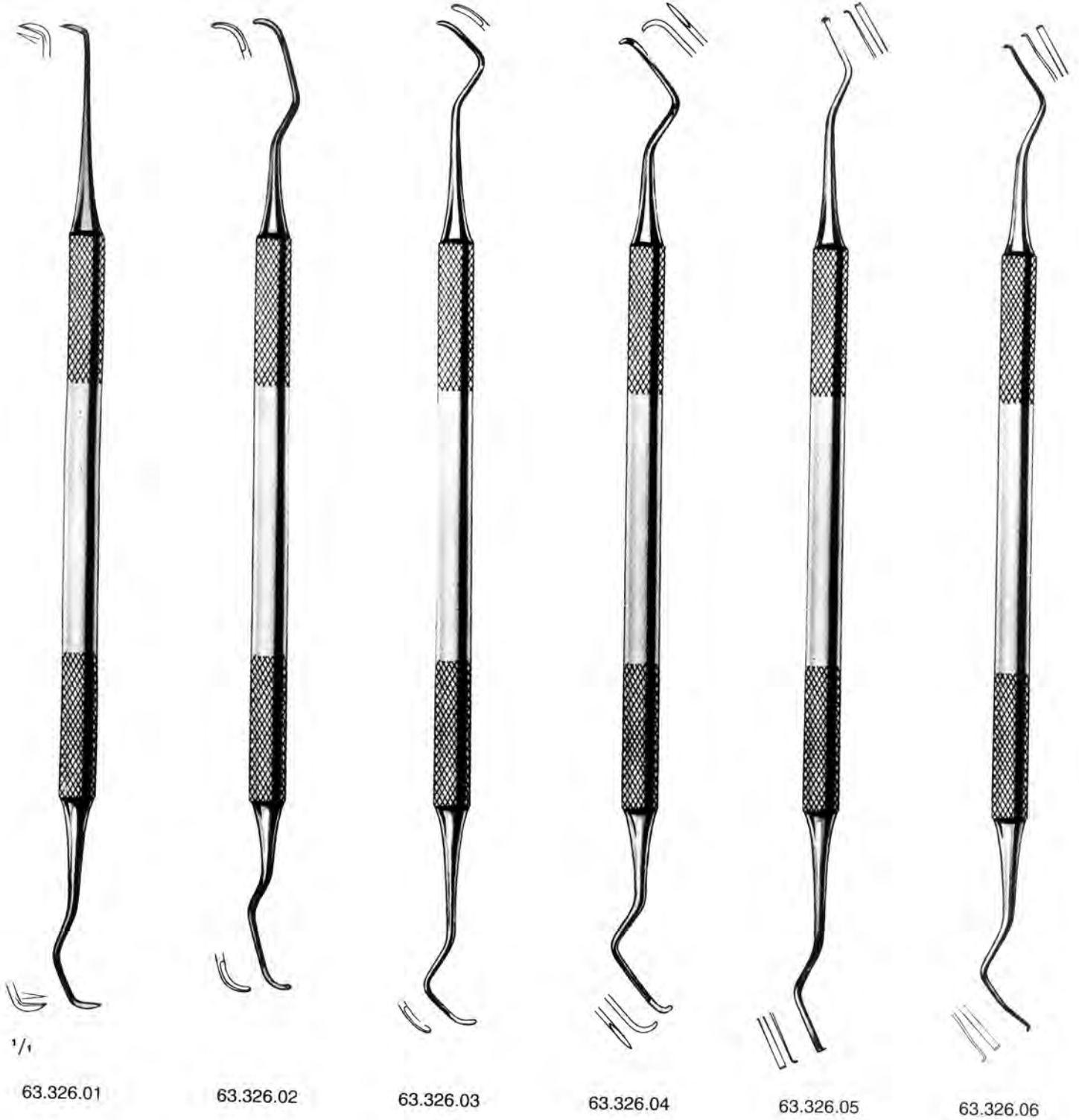





63.326.07



63.326.08



63.326.09



63.326.10



63.326.11



63.326.12



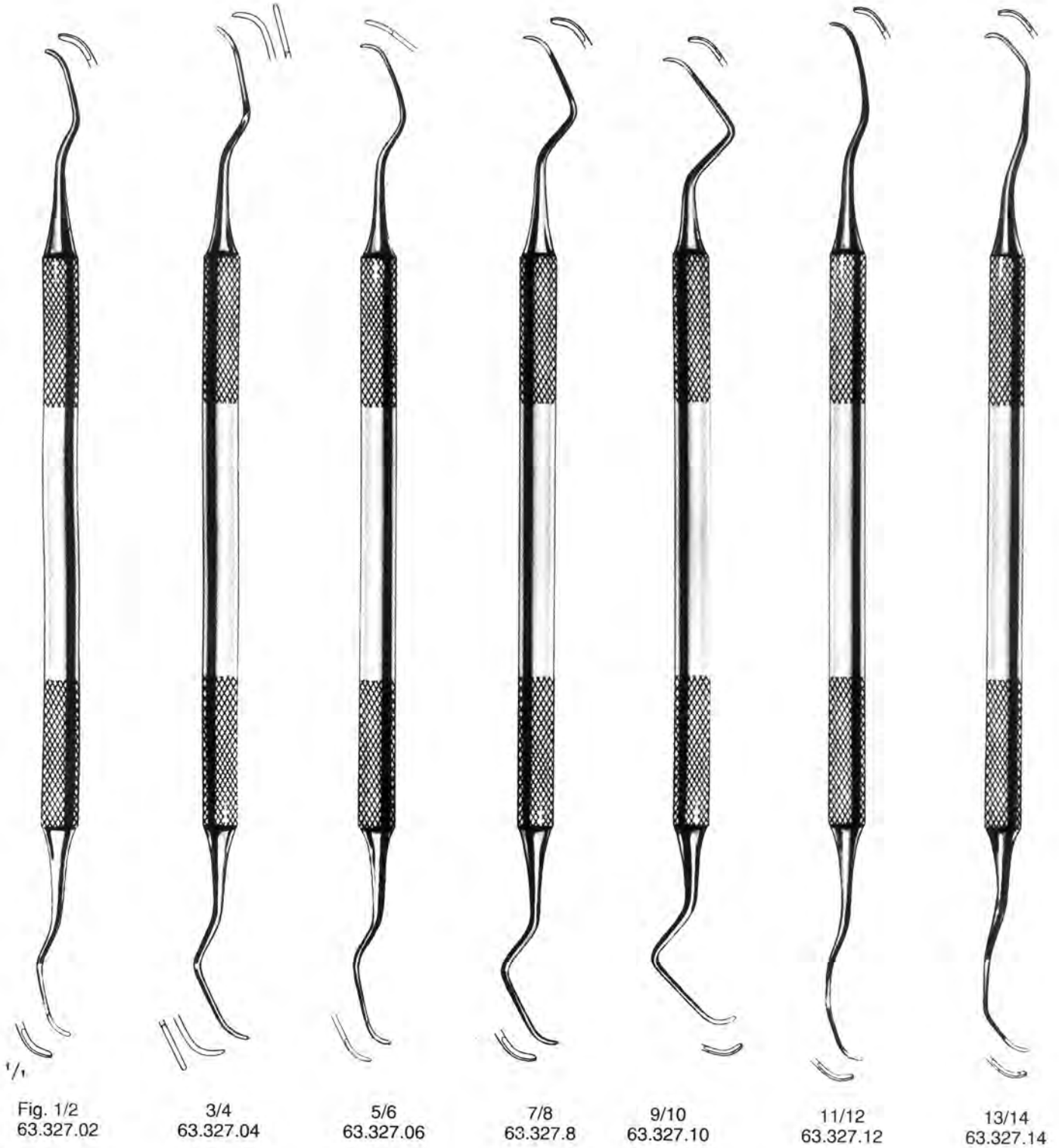



MERCITAN  
63.328.04

63.329.02

63.330.01

63.330.02

WARD-KIRKLAND  
63.330.03

63.330.04

63.330.05



1/1

KIRKLAND  
63.331.15



KIRKLAND  
63.331.16



KIRKLAND  
63.332.16



1/1

CRANE-KAPLAN  
63.343.01 63.343.02



1/1

63.345.01



63.346.01



63.346.02

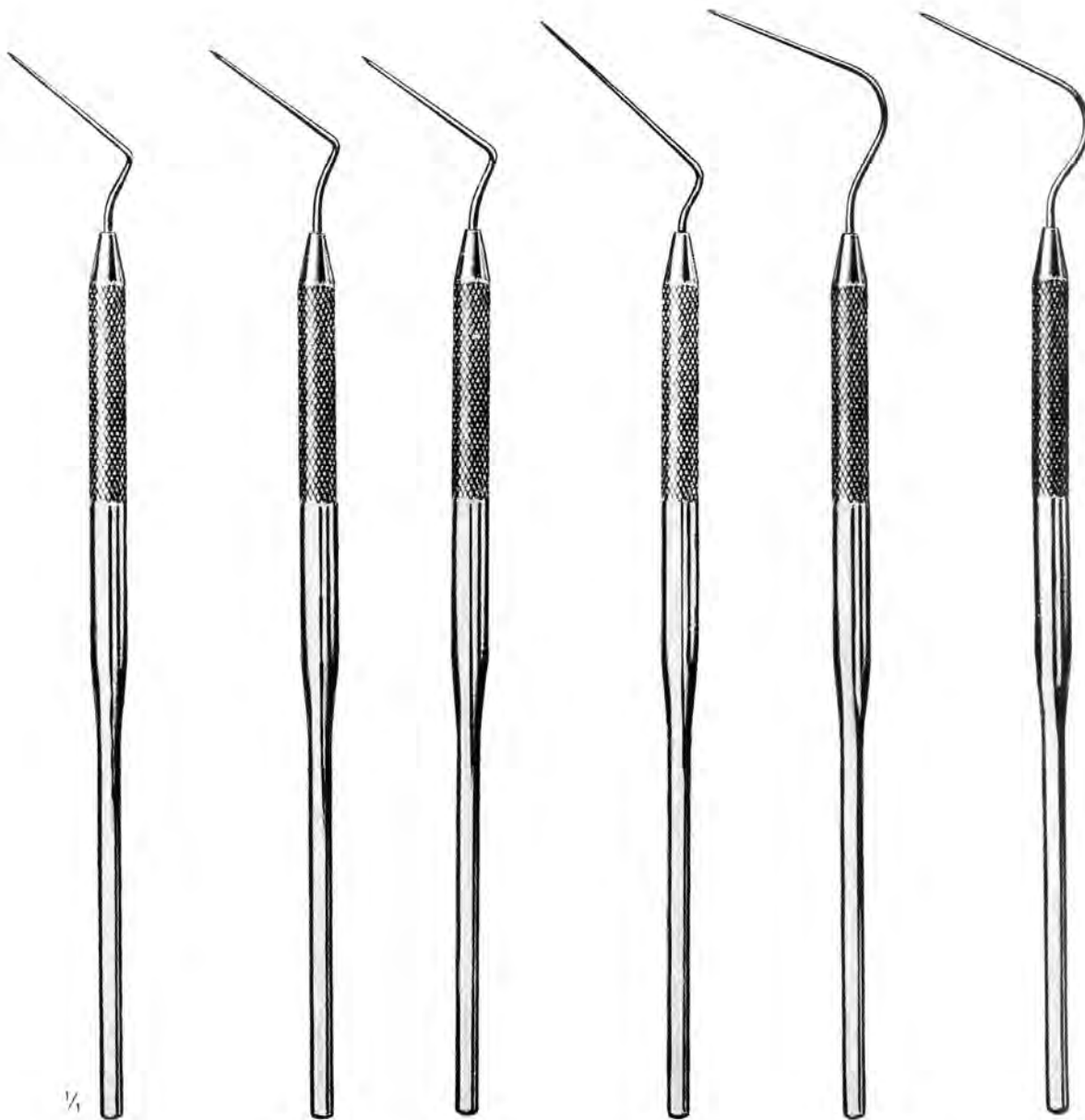

¼

Fig. 8  
63.352.08

10  
63.352.10

11  
63.352.11

0  
63.353.00

W  
63.354.00

WHO  
63.355.00

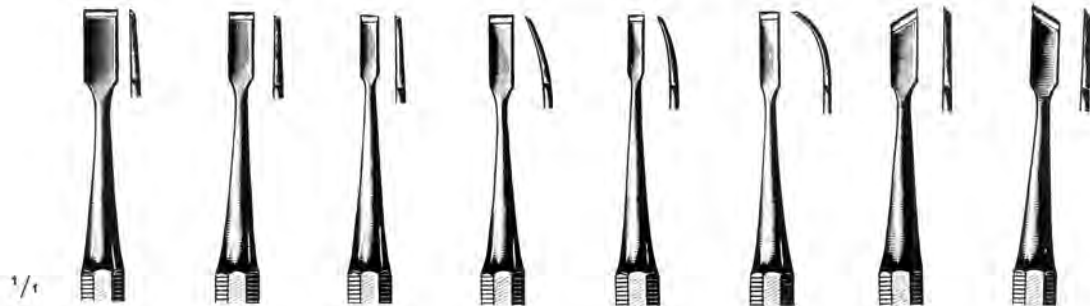
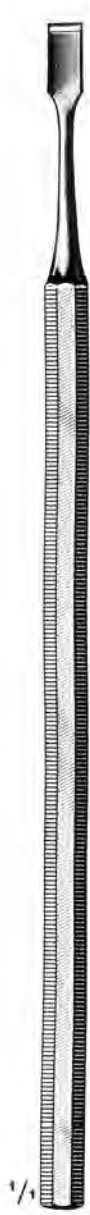

1/1

Fig. 1      3      5      6      11      12      17      18  
 WHITE  
 63.361.01    63.361.03    63.361.05    63.361.06    63.361.11    63.361.12    63.361.17    63.361.18

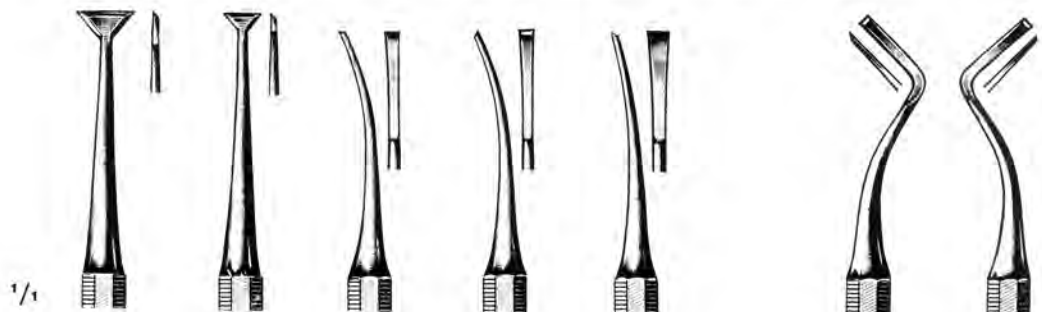

1/1

Fig. 48      48 S      50      51      52      1      2  
 WHITE      HOSPITAL  
 63.361.48    63.361.49    63.361.50    63.361.51    63.361.52    63.365.01    63.365.02

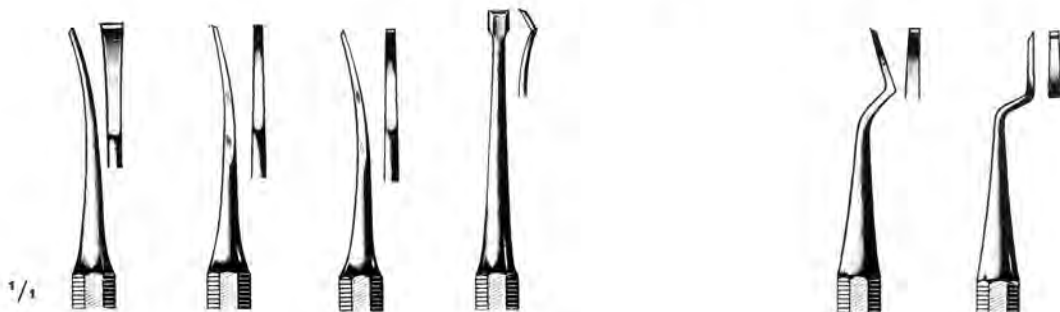

1/1

Fig. 39      40      41      43      1      2  
 WEDELSTAEDT      MITCHELL  
 63.367.39    63.367.40    63.367.41    63.367.43    63.369.01    63.369.02

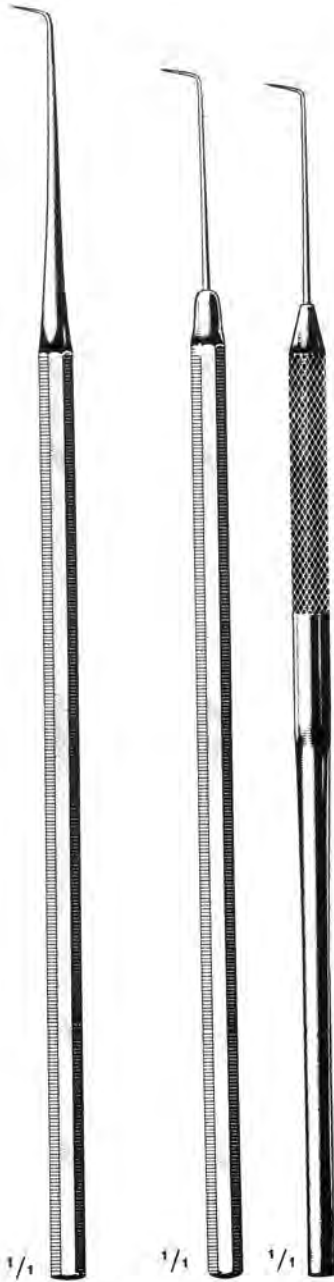

1/1 63.401.01 to 63.401.16  
 1/1 63.404.01 to 63.404.16  
 1/1 63.405.01 to 63.405.16



Fig. 1 2 3 6 7 8  
 WHITE  
 63.401.01 63.401.02 63.401.03 63.401.06 63.401.07 63.401.08  
 63.404.01 63.404.02 63.404.03 63.404.06 63.404.07 63.404.08  
 63.405.01 63.405.02 63.405.03 63.405.06 63.405.07 63.405.08

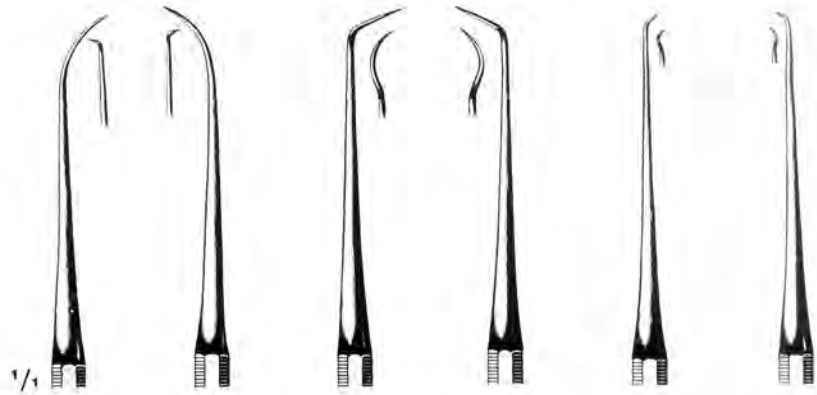
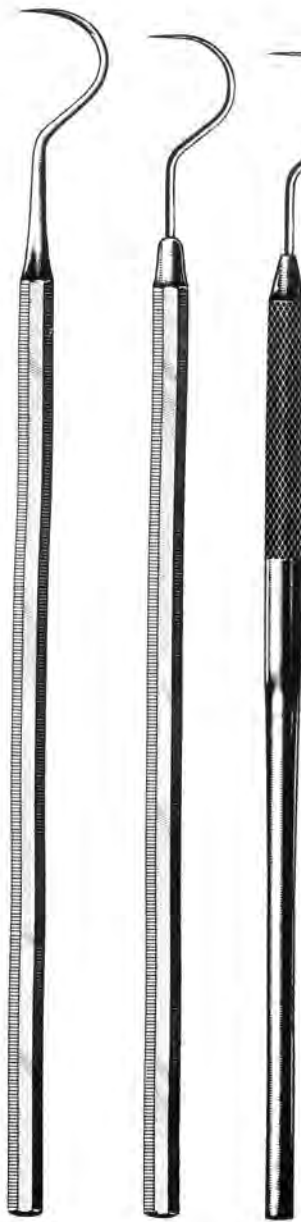

Fig. 9 10 11 12 15 16  
 WHITE  
 63.401.09 63.401.10 63.401.11 63.401.12 63.401.15 63.401.16  
 63.404.09 63.404.10 63.404.11 63.404.12 63.404.15 63.404.16  
 63.405.09 63.405.10 63.405.11 63.405.12 63.405.15 63.405.16



|           |           |           |           |           |           |           |
|-----------|-----------|-----------|-----------|-----------|-----------|-----------|
| Fig. 17   | 21        | 22        | 23        | 33        | 34        | 35        |
| 63.401.17 | 63.401.21 | 63.401.22 | 63.401.23 | 63.401.33 | 63.401.34 | 63.401.35 |
| 63.404.17 | 63.404.21 | 63.404.22 | 63.404.23 | 63.404.33 | 63.404.34 | 63.404.35 |
| 63.405.17 | 63.405.21 | 63.405.22 | 63.405.23 | 63.405.33 | 63.405.34 | 63.405.35 |



|           |           |           |           |           |           |           |
|-----------|-----------|-----------|-----------|-----------|-----------|-----------|
| Fig. 39   | 40        | 41        | Fig. 42   | 43        | 44        | 45        |
| 63.401.39 | 63.401.40 | 63.401.41 | 63.401.42 | 63.401.43 | 63.401.44 | 63.401.45 |
| 63.404.39 | 63.404.40 | 63.404.41 | 63.404.42 | 63.404.43 | 63.404.44 | 63.404.45 |
| 63.405.39 | 63.405.40 | 63.405.41 | 63.405.42 | 63.405.43 | 63.405.44 | 63.405.45 |

WHITE

|           |           |           |           |           |           |           |           |           |           |
|-----------|-----------|-----------|-----------|-----------|-----------|-----------|-----------|-----------|-----------|
| 63.401.17 | 63.404.17 | 63.405.17 | 63.401.39 | 63.401.40 | 63.401.41 | 63.401.42 | 63.401.43 | 63.401.44 | 63.401.45 |
| to        | to        | to        | 63.404.39 | 63.404.40 | 63.404.41 | 63.404.42 | 63.404.43 | 63.404.44 | 63.404.45 |
| 63.401.45 | 63.404.45 | 63.405.45 | 63.405.39 | 63.405.40 | 63.405.41 | 63.405.42 | 63.405.43 | 63.405.44 | 63.405.45 |

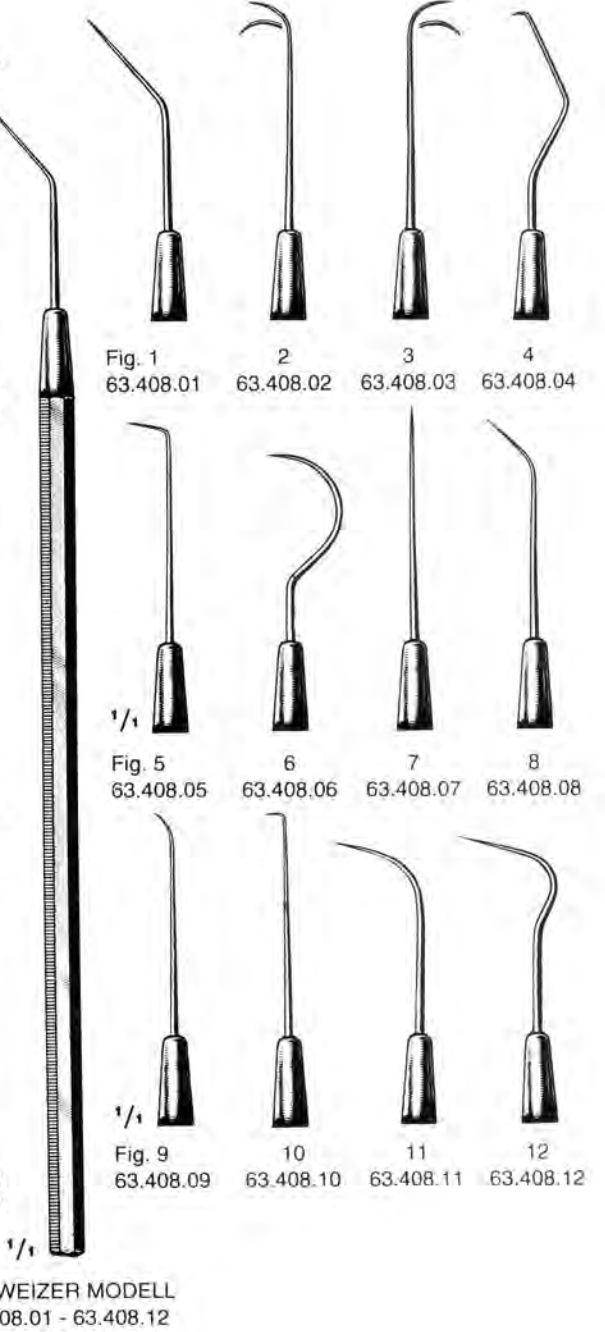
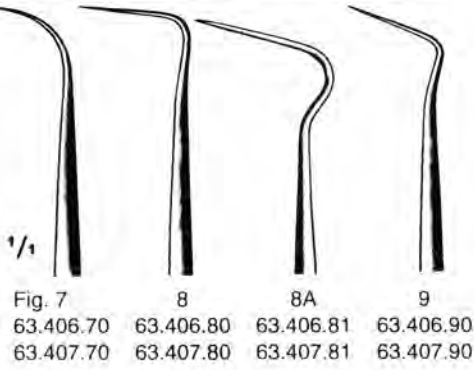
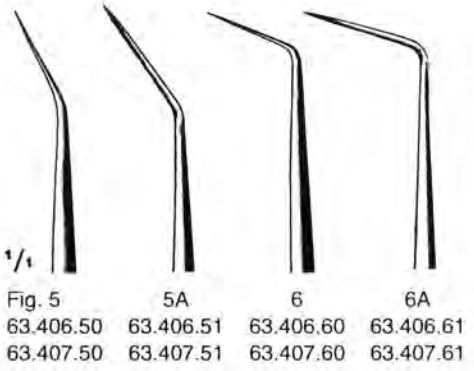
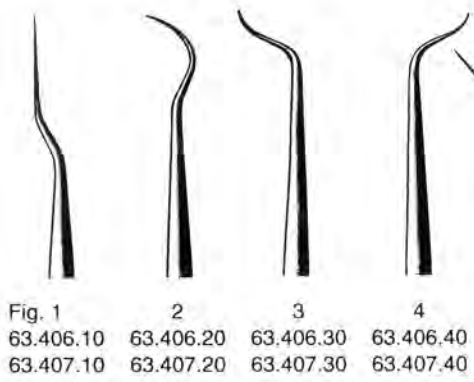
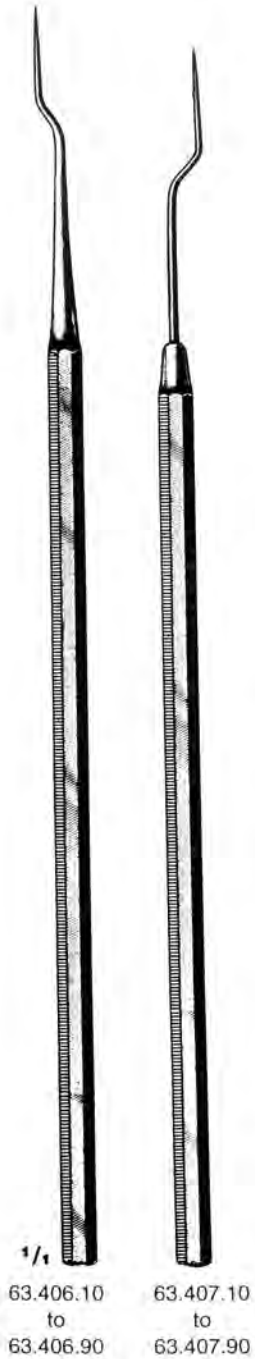



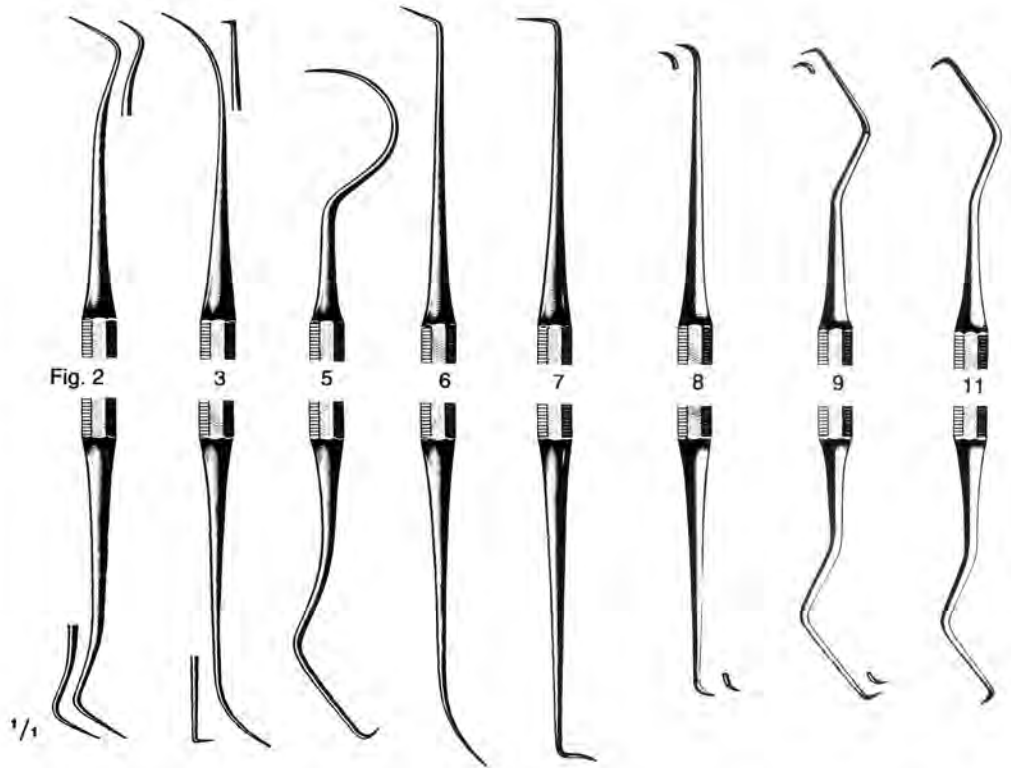
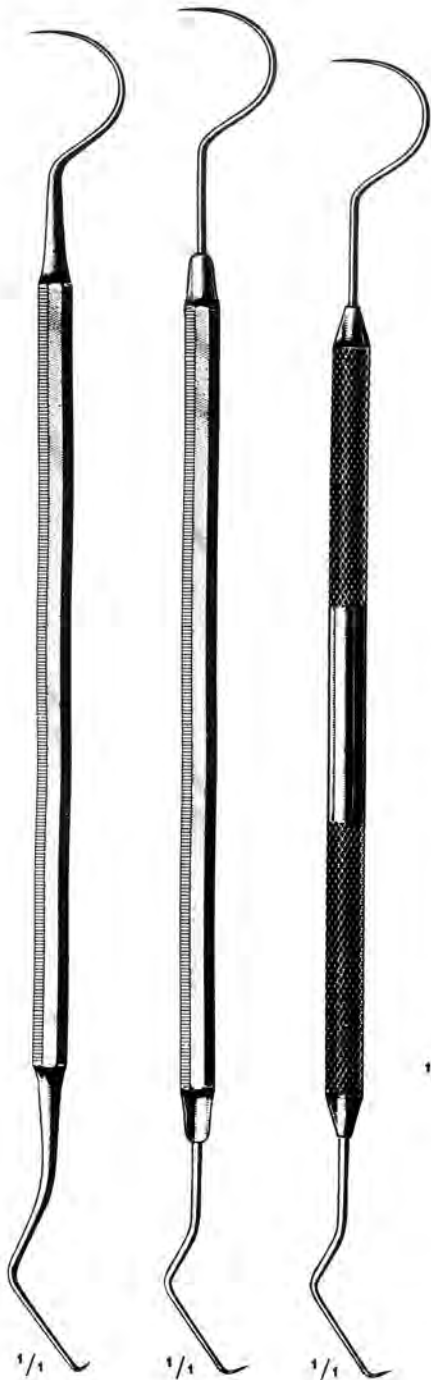

|           |           |           |           |           |           |           |           |
|-----------|-----------|-----------|-----------|-----------|-----------|-----------|-----------|
| 63.421.02 | 63.421.03 | 63.421.05 | 63.421.06 | 63.421.07 | 63.421.08 | 63.421.09 | BRIAULT   |
| 63.424.02 | 63.424.03 | 63.424.05 | 63.424.06 | 63.424.07 | 63.424.08 | 63.424.09 | 63.421.11 |
| 63.425.02 | 63.425.03 | 63.425.05 | 63.425.06 | 63.425.07 | 63.425.08 | 63.425.09 | 63.424.11 |
|           |           |           |           |           |           |           | 63.425.11 |

|           |           |           |
|-----------|-----------|-----------|
| 63.421.02 | 63.424.02 | 63.425.02 |
| to        | to        | to        |
| 63.421.11 | 63.424.11 | 63.425.11 |

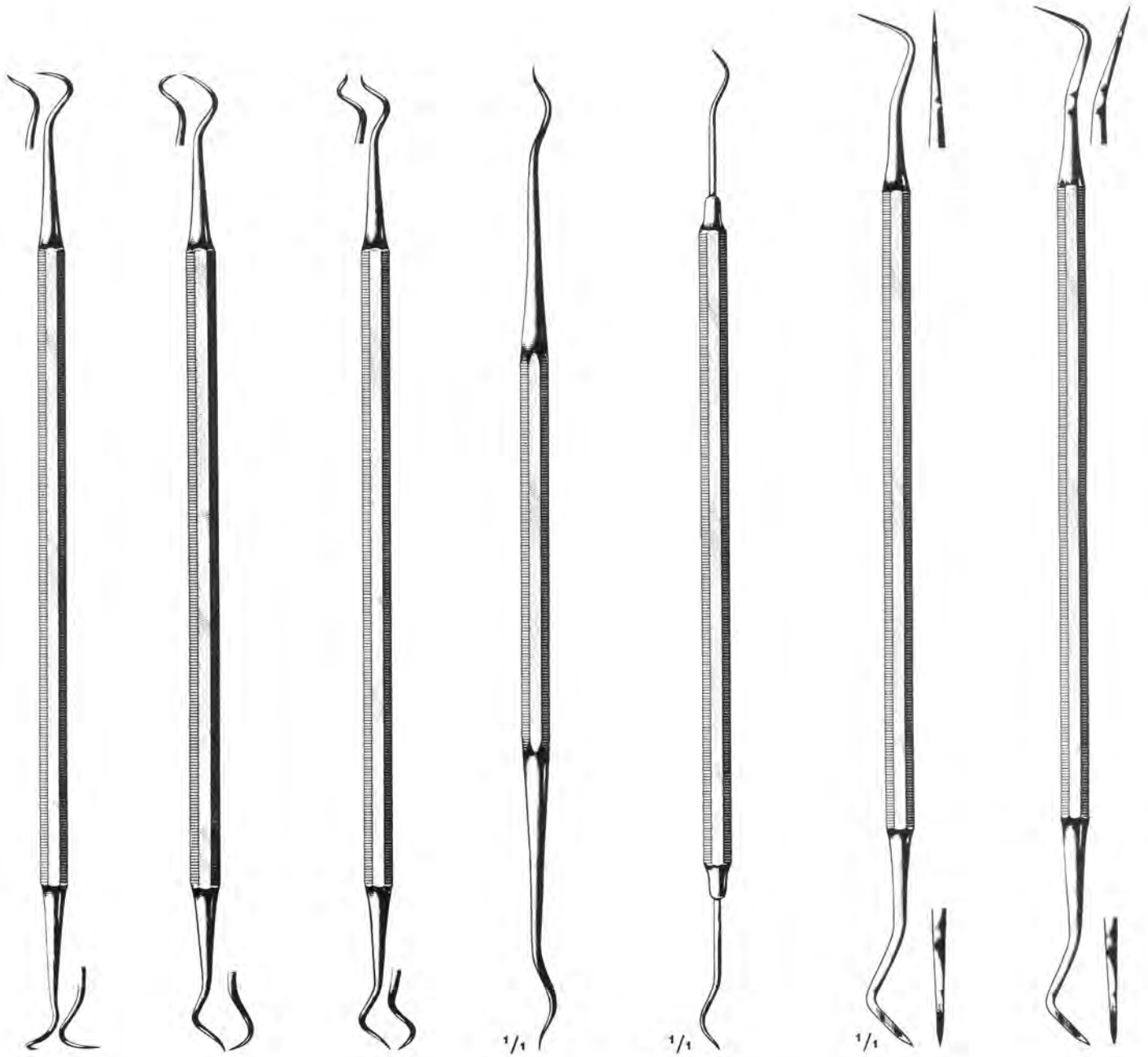

63.427.01

63.427.02

63.427.03

1/1

WESTON  
63.429.01

1/1

WESTON  
63.431.01

1/1

LANGE  
63.433.01

LANGE  
63.433.02

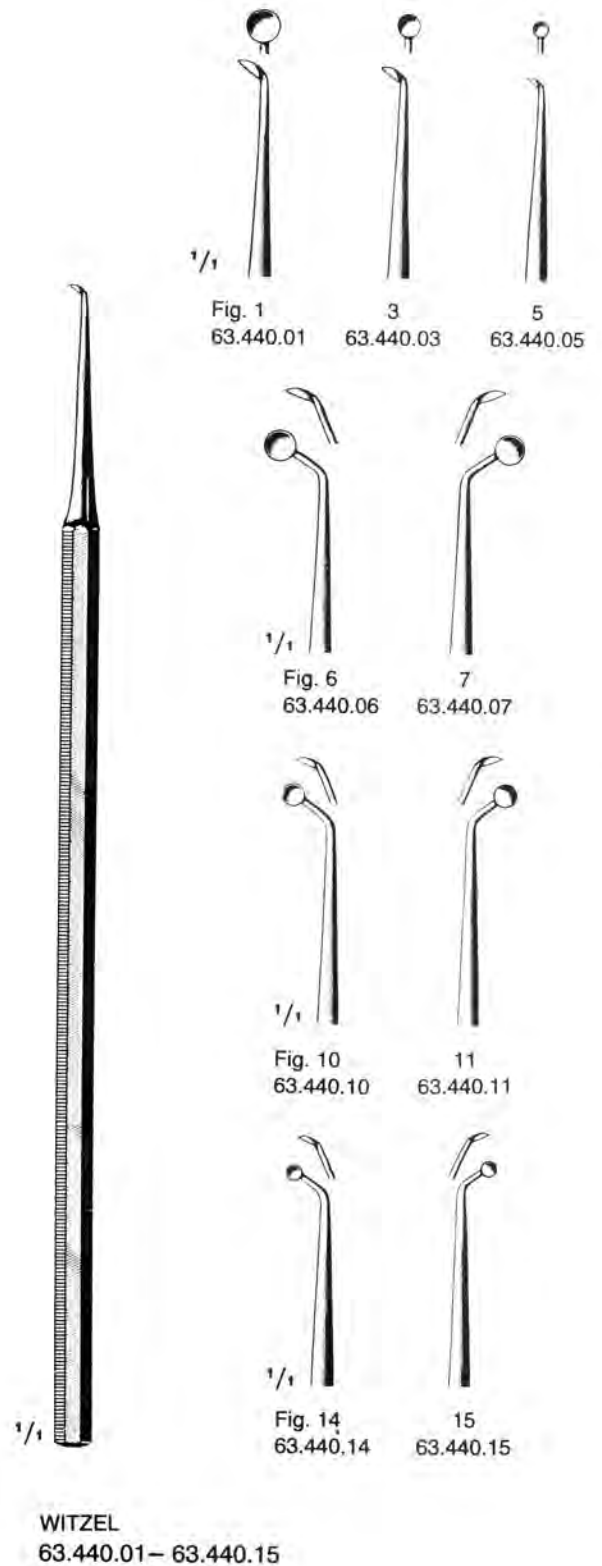
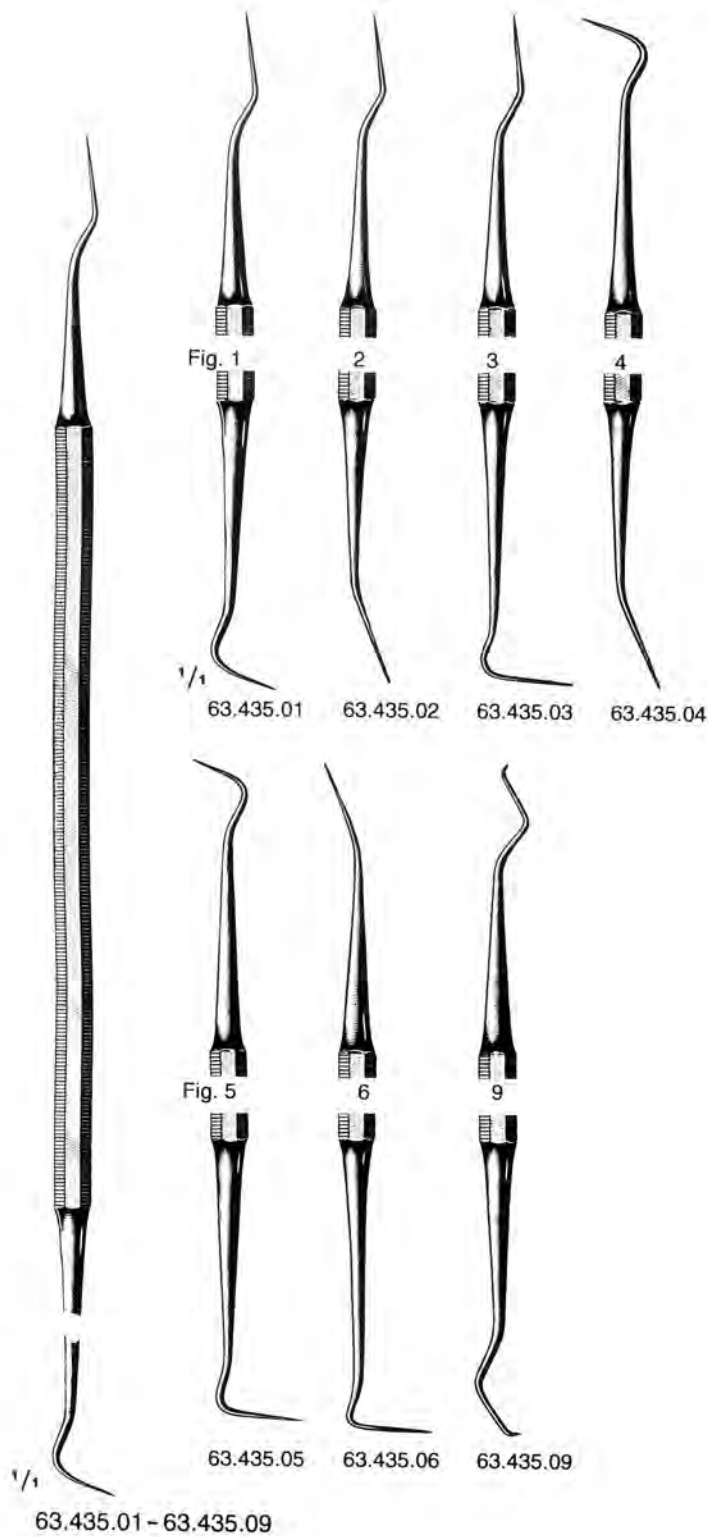

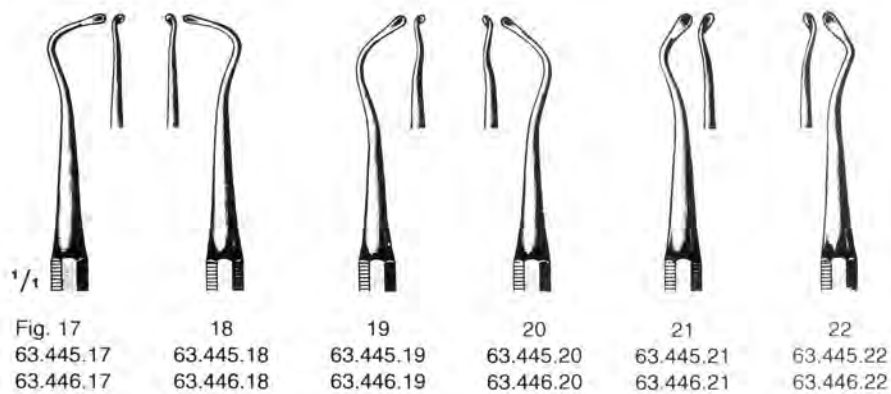
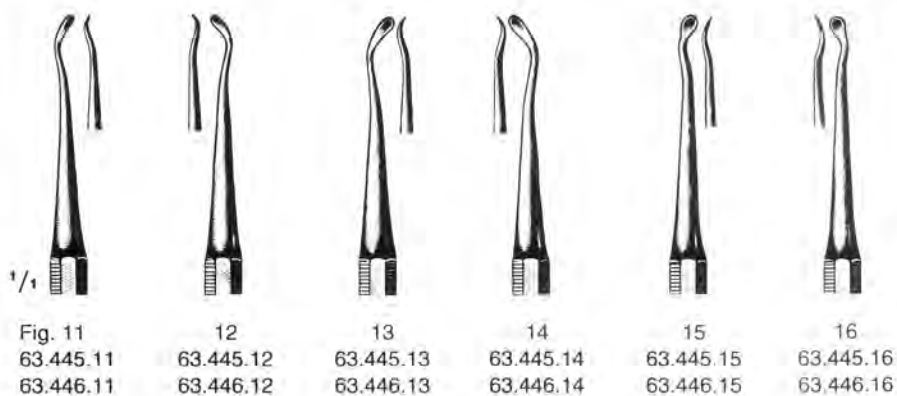
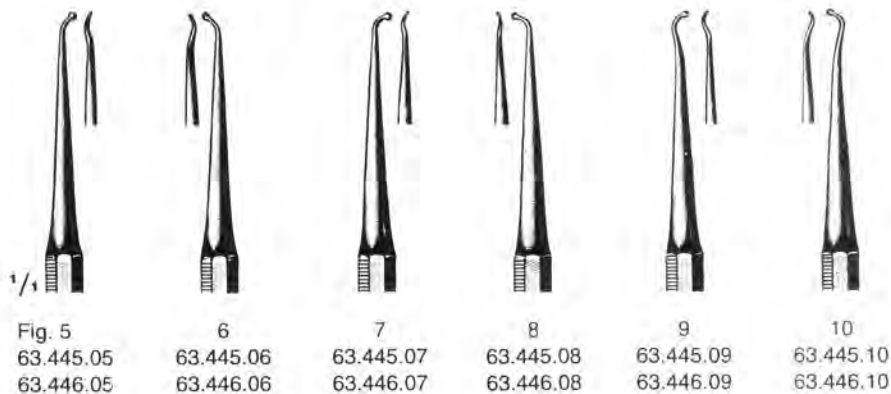
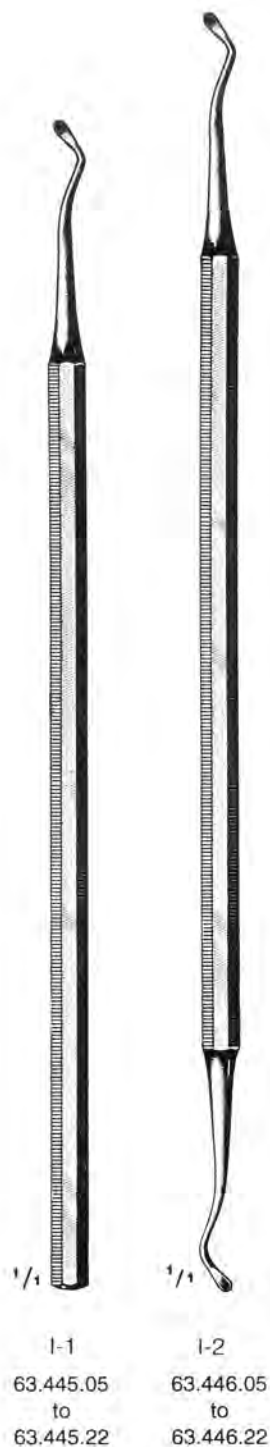

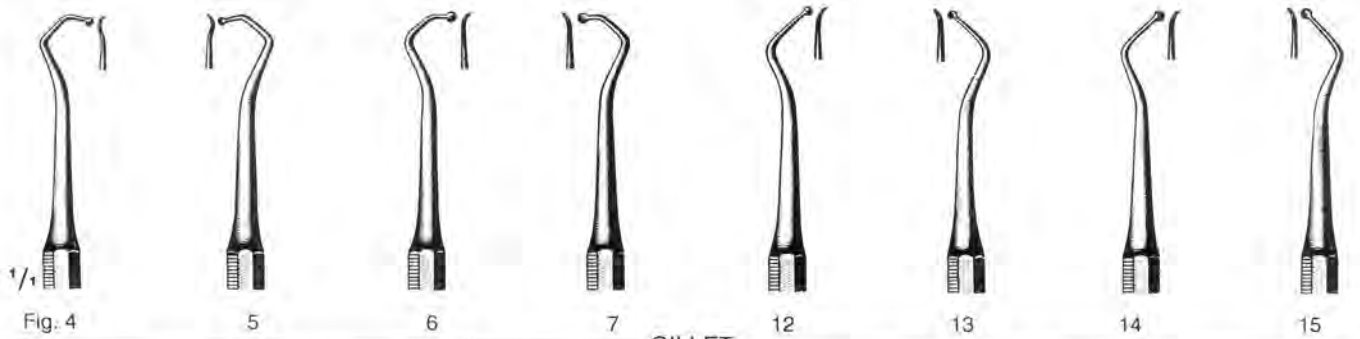

|           |           |           |           |           |           |           |           |           |    |
|-----------|-----------|-----------|-----------|-----------|-----------|-----------|-----------|-----------|----|
| Fig. 4    | 5         | 6         | 7         | GILLET    |           | 12        | 13        | 14        | 15 |
| 63.450.04 | 63.450.05 | 63.450.06 | 63.450.07 | 63.450.12 | 63.450.13 | 63.450.14 | 63.450.14 | 63.450.15 |    |
| Fig. 4/5  |           | 6/7       |           | 12/13     |           | 14/15     |           |           |    |
| 63.451.04 |           | 63.451.06 |           | 63.451.12 |           | 63.451.14 |           |           |    |



|     |              |           |           |           |           |           |           |           |
|-----|--------------|-----------|-----------|-----------|-----------|-----------|-----------|-----------|
| I-1 | Fig. 171     | 172       | 173       | 174       | 175       | 176       | 177       | 178       |
|     | 63.461.71    | 63.461.72 | 63.461.73 | 63.461.74 | 63.461.75 | 63.461.76 | 63.461.77 | 63.461.78 |
| I-2 | Fig. 171/172 |           | 173/174   |           | 175/176   |           | 177/178   |           |
|     | 63.462.71    |           | 63.462.73 |           | 63.462.75 |           | 63.462.77 |           |



|     |              |           |           |           |           |           |           |           |
|-----|--------------|-----------|-----------|-----------|-----------|-----------|-----------|-----------|
| I-1 | Fig. 179     | 180       | 3         | 4         | 7         | 8         | 9         | 10        |
|     | 63.461.79    | 63.461.80 | 63.465.03 | 63.465.04 | 63.465.07 | 63.465.08 | 63.465.09 | 63.465.10 |
| I-2 | Fig. 179/180 |           | 3/4       |           | 7/8       |           | 9/10      |           |
|     | 63.462.79    |           | 63.466.03 |           | 63.466.07 |           | 63.466.09 |           |

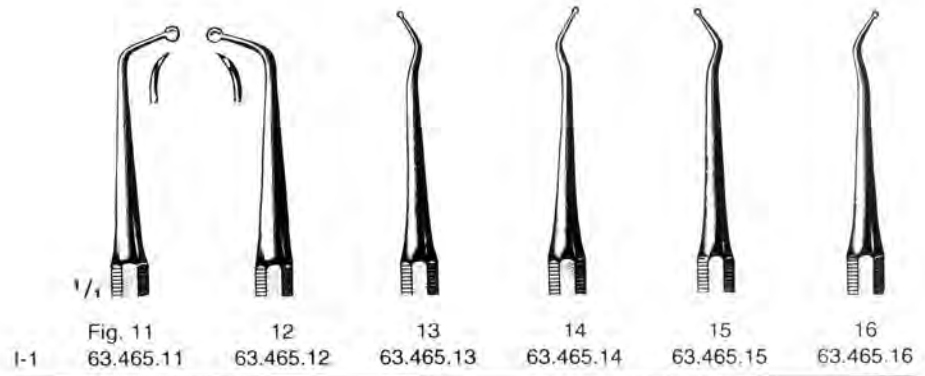
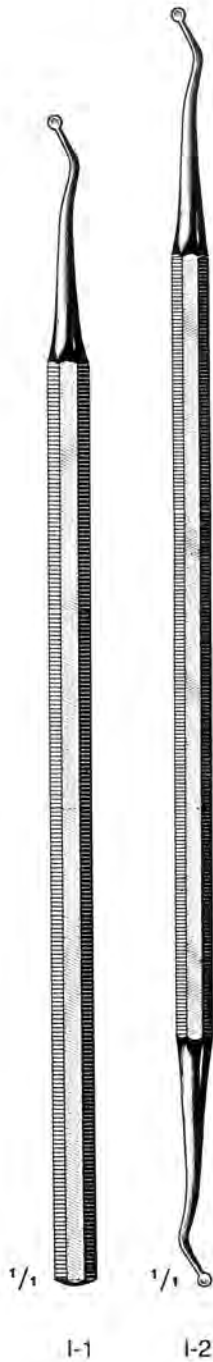

|     |           |           |           |           |           |           |
|-----|-----------|-----------|-----------|-----------|-----------|-----------|
|     | Fig. 11   | 12        | 13        | 14        | 15        | 16        |
| I-1 | 63.465.11 | 63.465.12 | 63.465.13 | 63.465.14 | 63.465.15 | 63.465.16 |



|     |           |           |           |           |           |           |
|-----|-----------|-----------|-----------|-----------|-----------|-----------|
|     | Fig. 17   | 18        | 19        | 20        | 21        | 22        |
| I-1 | 63.465.17 | 63.465.18 | 63.465.19 | 63.465.20 | 63.465.21 | 63.465.22 |

|     |            |           |           |
|-----|------------|-----------|-----------|
|     | Fig. 17/18 | 19/20     | 21/22     |
| I-2 | 63.466.17  | 63.466.19 | 63.466.21 |

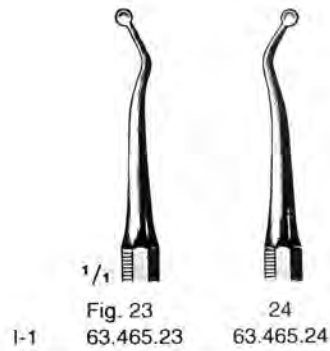

|     |           |           |
|-----|-----------|-----------|
|     | Fig. 23   | 24        |
| I-1 | 63.465.23 | 63.465.24 |

|     |            |
|-----|------------|
|     | Fig. 23/24 |
| I-2 | 63.466.23  |



|     |                         |           |                    |           |
|-----|-------------------------|-----------|--------------------|-----------|
|     | Fig. 25                 | 26        | 27                 | 28        |
| I-1 | 63.465.25               | 63.465.26 | 63.465.27          | 63.465.28 |
| I-2 | Fig. 25/26<br>63.466.25 |           | 27/28<br>63.466.27 |           |

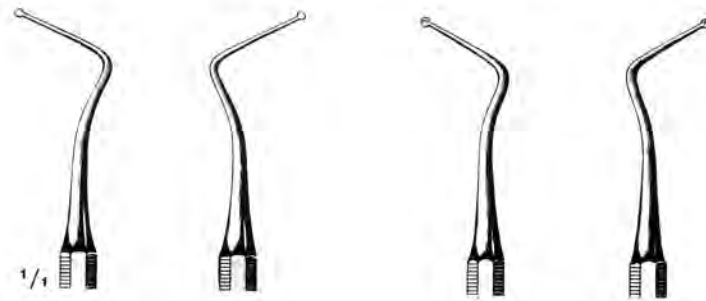

|     |                         |           |                    |           |
|-----|-------------------------|-----------|--------------------|-----------|
|     | Fig. 29                 | 30        | 31                 | 32        |
| I-1 | 63.465.29               | 63.465.30 | 63.465.31          | 63.465.32 |
| I-2 | Fig. 29/30<br>63.466.29 |           | 31/32<br>63.466.31 |           |

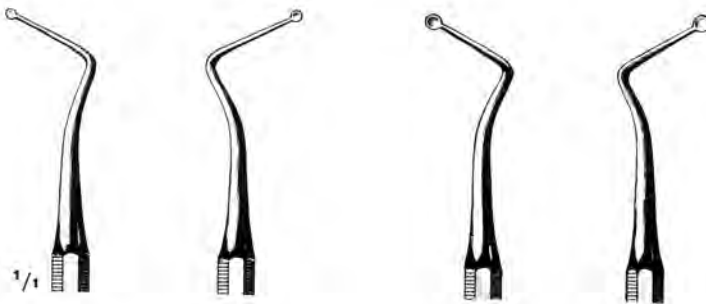

|     |                         |           |                    |           |
|-----|-------------------------|-----------|--------------------|-----------|
|     | Fig. 33                 | 34        | 35                 | 36        |
| I-1 | 63.465.33               | 63.465.34 | 63.465.35          | 63.465.36 |
| I-2 | Fig. 33/34<br>63.466.33 |           | 35/36<br>63.466.35 |           |

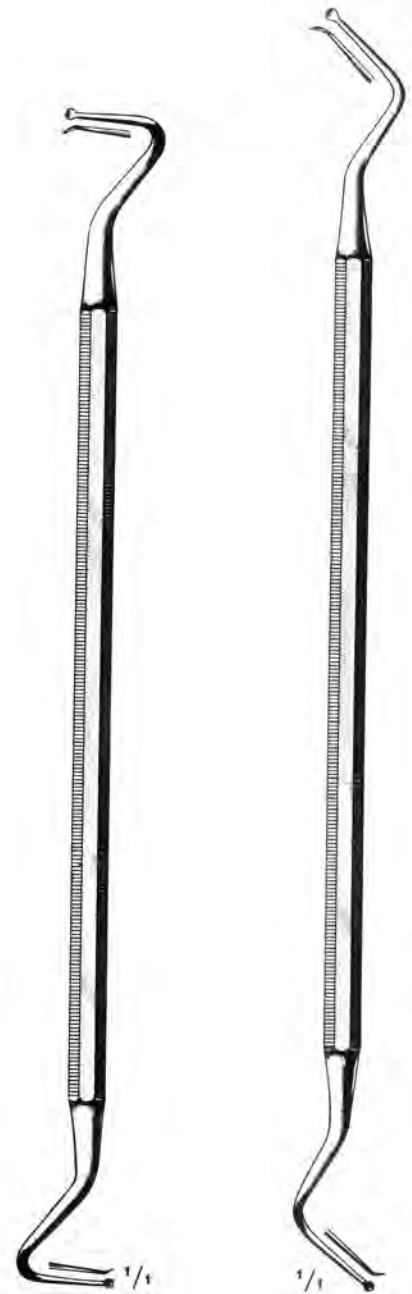

FRIEDMAN  
63.475.30

FRIEDMAN  
63.475.31

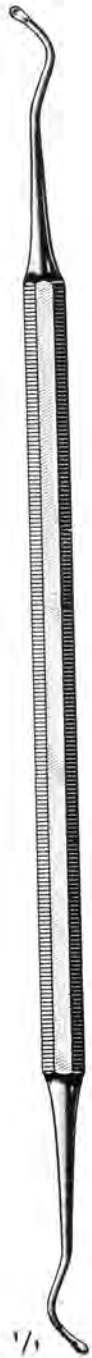

63.481.05    63.481.14    63.481.17    63.481.18    63.481.19    63.481.20

WHITE



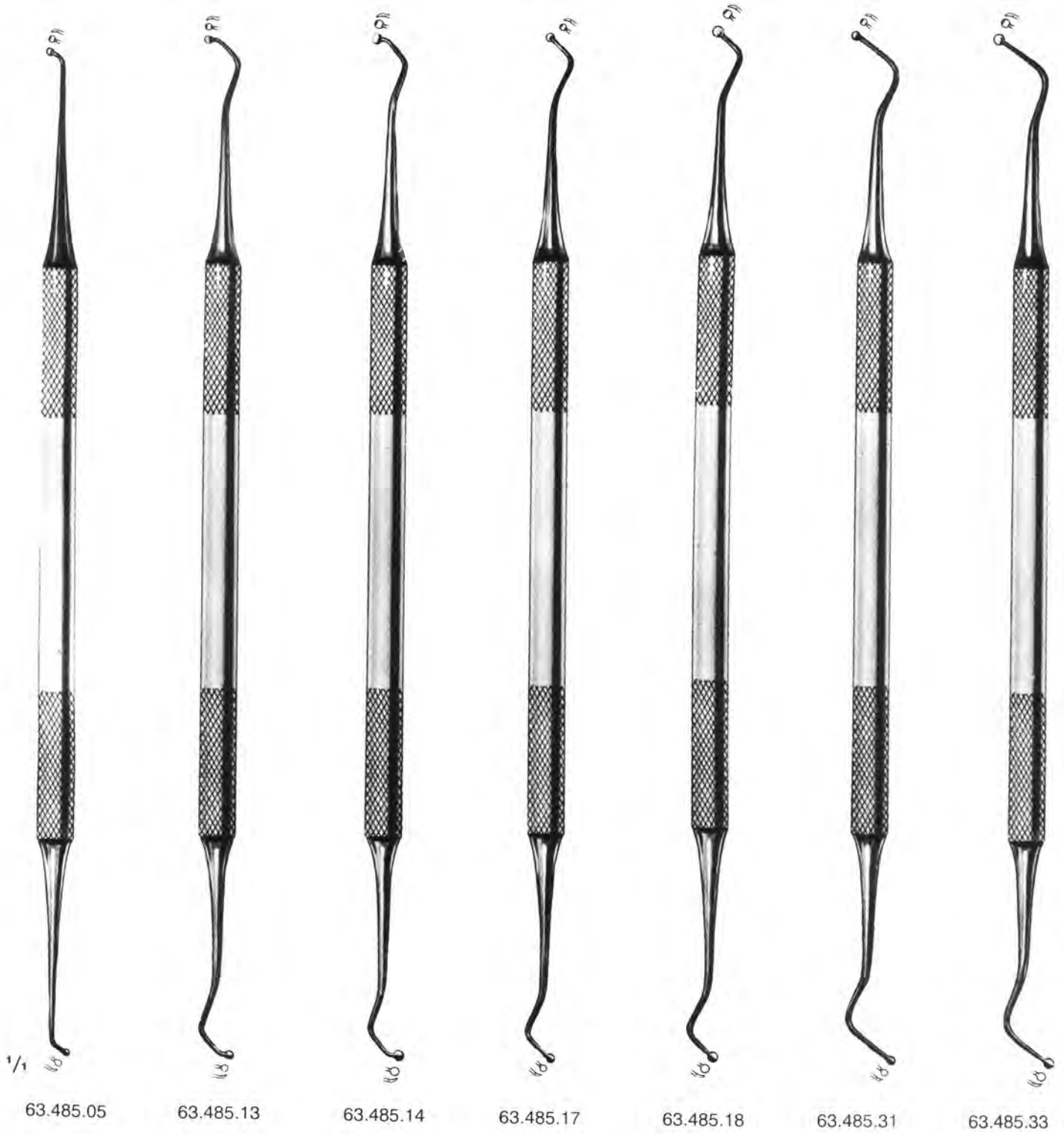



BLACK  
 63.491.03 - 63.491.99

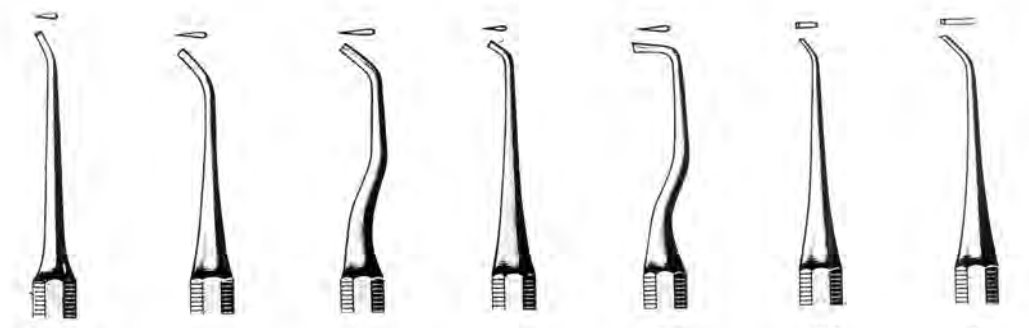

Fig. 3 9 14 17 20 28 32  
 63.491.03 63.491.09 63.491.14 63.491.17 63.491.20 63.491.28 63.491.32

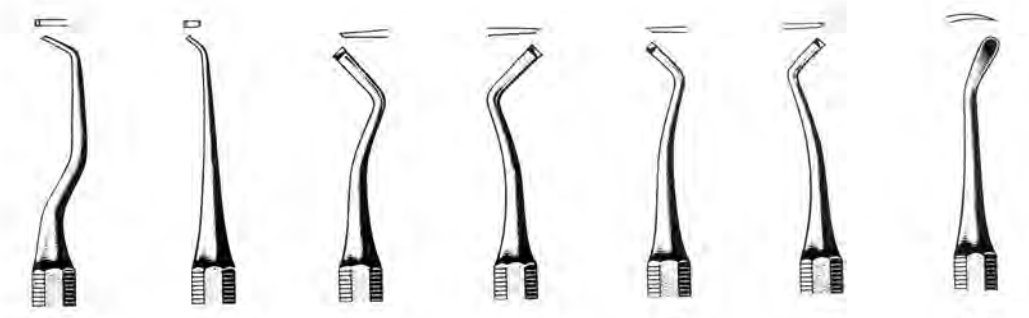

Fig. 38 41 51 52 53 54 57  
 63.491.38 63.491.41 63.491.51 63.491.52 63.491.53 63.491.54 63.491.57

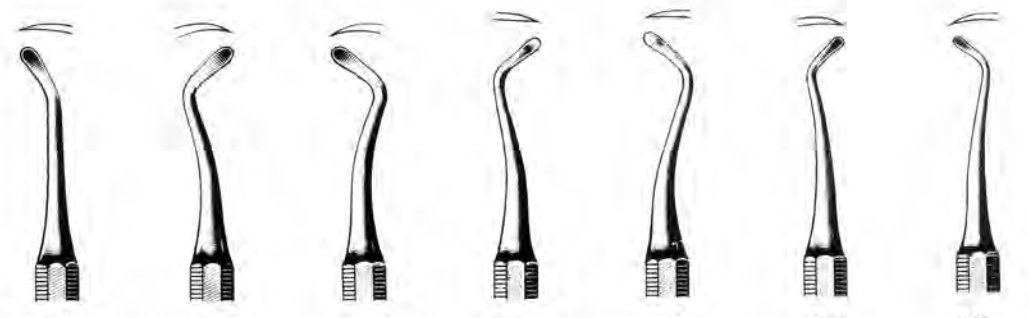

Fig. 58 61 62 63 64 65 66  
 63.491.58 63.491.61 63.491.62 63.491.63 63.491.64 63.491.65 63.491.66



Fig. 69  
63.491.69



70  
63.491.70



73  
63.491.73



74  
63.491.74



75  
63.491.75



76  
63.491.76



77  
63.491.77



78  
63.491.78



Fig. 81  
63.491.81



82  
63.491.82



83  
63.491.83



84  
63.491.84



85  
63.491.85



86  
63.491.86



87  
63.491.87



90  
63.491.90



Fig. 93  
63.491.93



95  
63.491.95



98  
63.491.98



99  
63.491.99

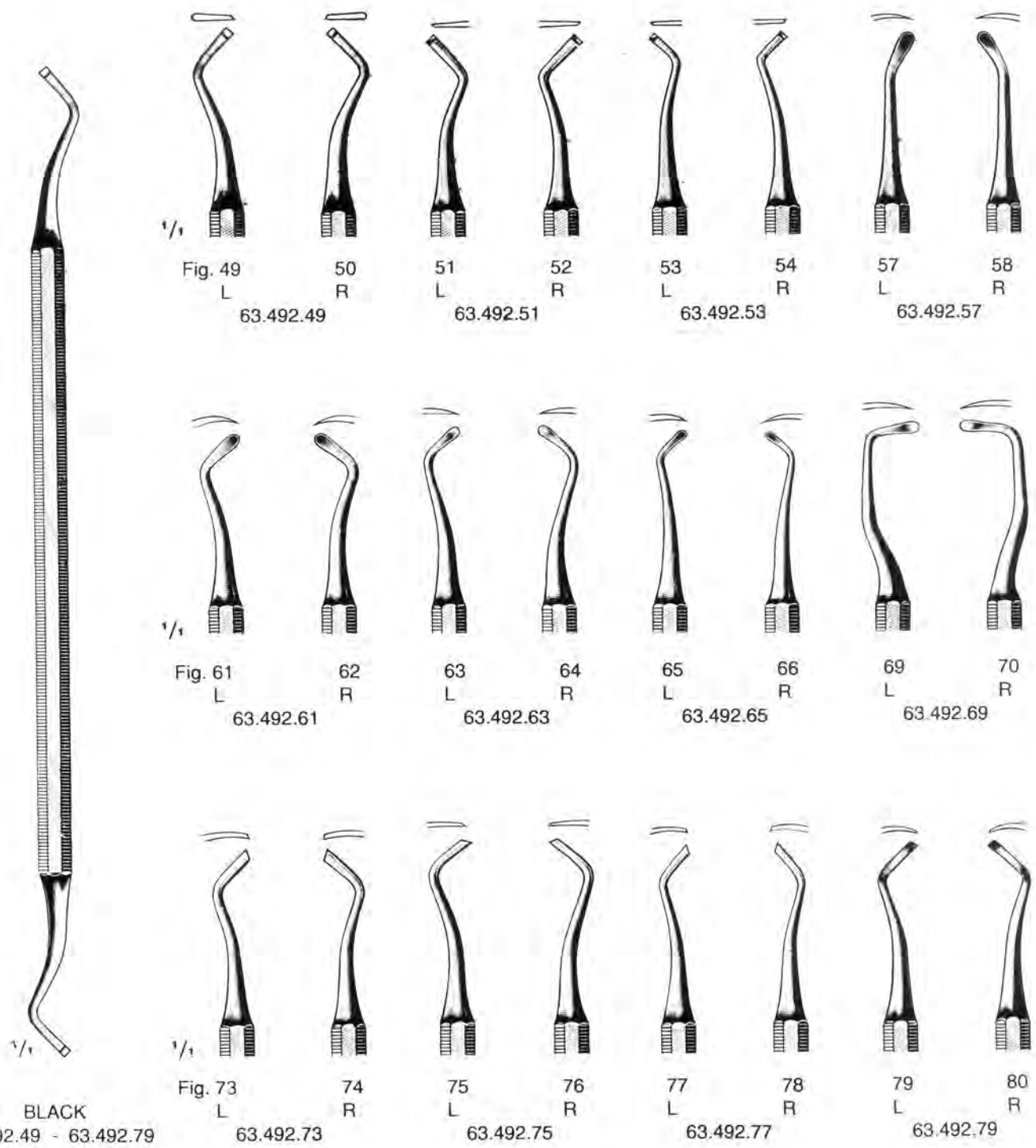

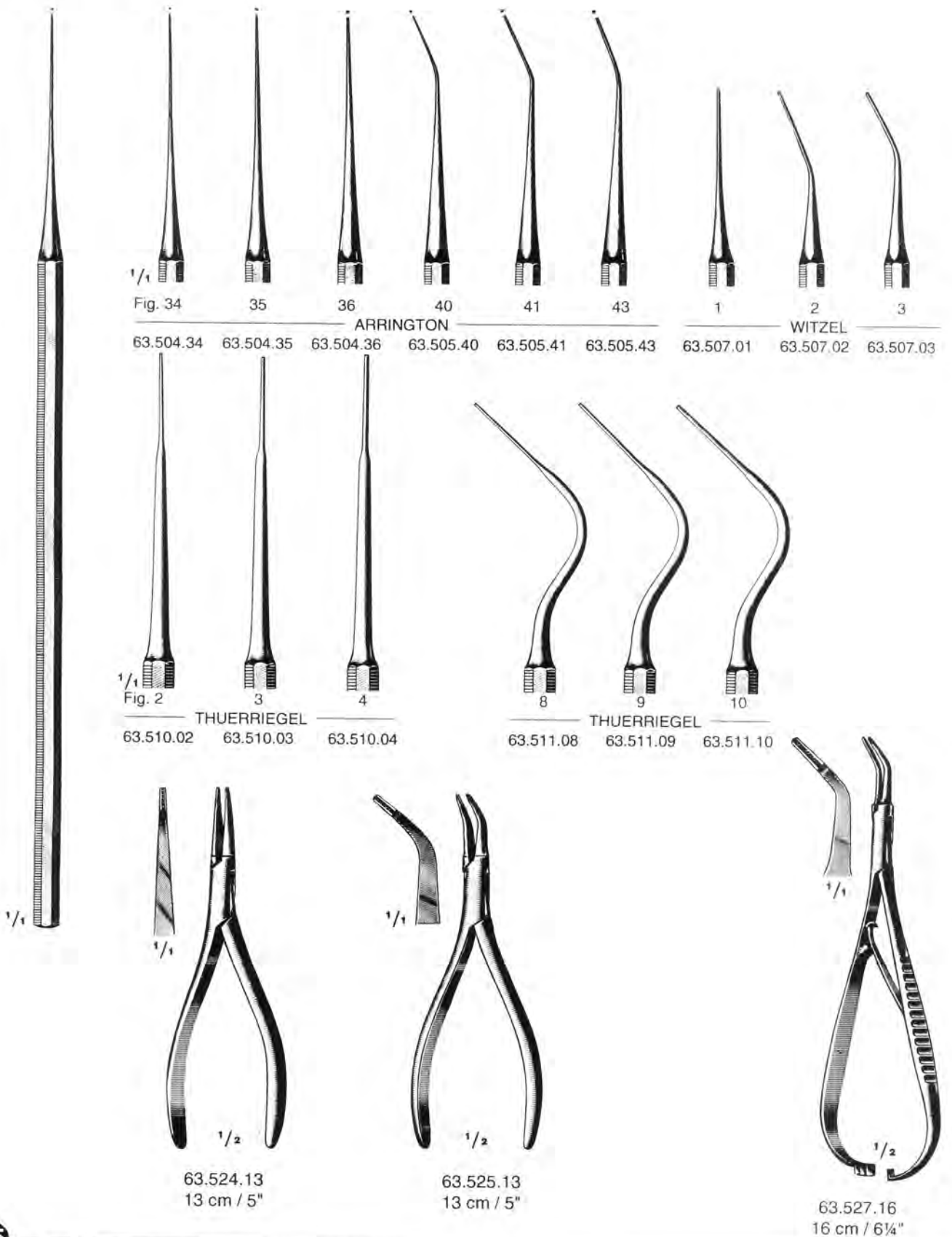



MINI-FRIEDMAN  
 63.799.12  
 12 cm / 5"



FRIEDMAN  
 63.801.14  
 14 cm / 5½"



MEAD  
 63.815.16  
 16.5 cm / 6½"  
 (Fig. 1A)



MEAD  
 63.817.16  
 16.5 cm / 6½"  
 (Fig. 2A)



BLUMENTHAL  
 63.835.15  
 15.5 cm / 6"



BLUMENTHAL  
 63.837.15  
 15.5 cm / 6"



BLUMENTHAL  
 63.839.15  
 15.5 cm / 6"



LUER  
63.853.15  
15 cm / 6"



LUER  
15 cm / 6"



Fig. 1  
63.864.15



Fig. 2  
63.865.15



1/4

1/2



BEYER  
63.879.18  
18 cm / 7"



CLEVELAND  
63.939.17  
17 cm / 6 3/4"



CLEVELAND-GARDENER  
16 cm / 6 1/4"



Fig. 6 A  
63.947.16



Fig. 6  
63.949.16



**CHEATLE**  
 64.020.27  
 27 cm / 10½"



64.040.20 20 cm / 8"  
 64.042.30 30 cm / 12"

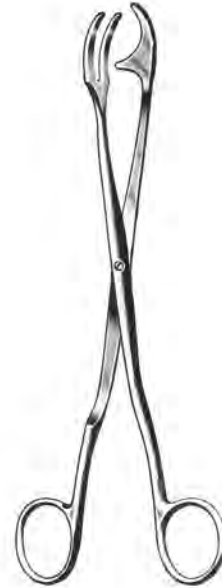

**ROGGE**  
 64.050.23  
 23 cm / 9"



**UNIVERSAL**  
 64.080.20 20 cm / 8"  
 64.082.28 28 cm / 11"



**UNIVERSAL**  
 64.081.20  
 64.083.28



**DAVIS**  
 64.090.16 16 cm / 6¼"  
 64.092.20 20 cm / 8"  
 64.094.24 24 cm / 9½"



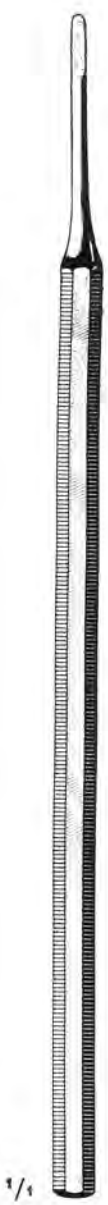
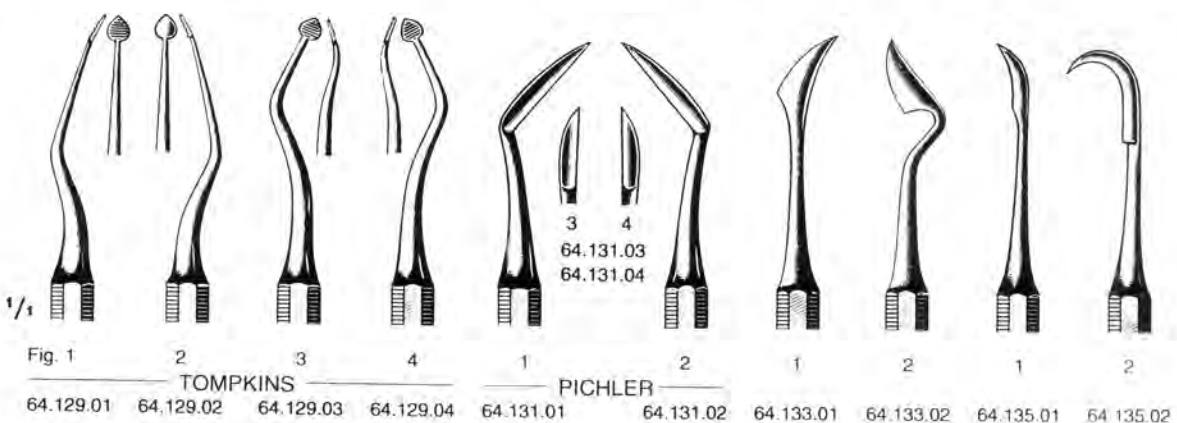
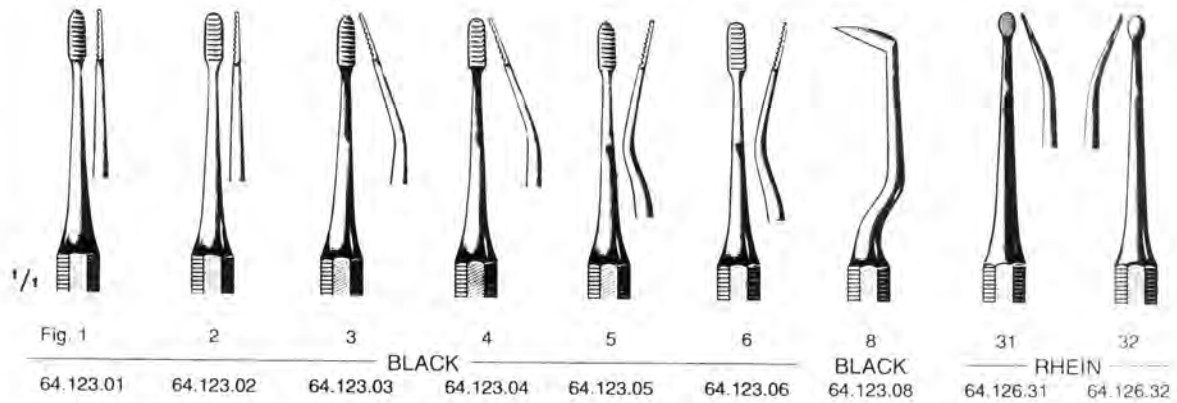
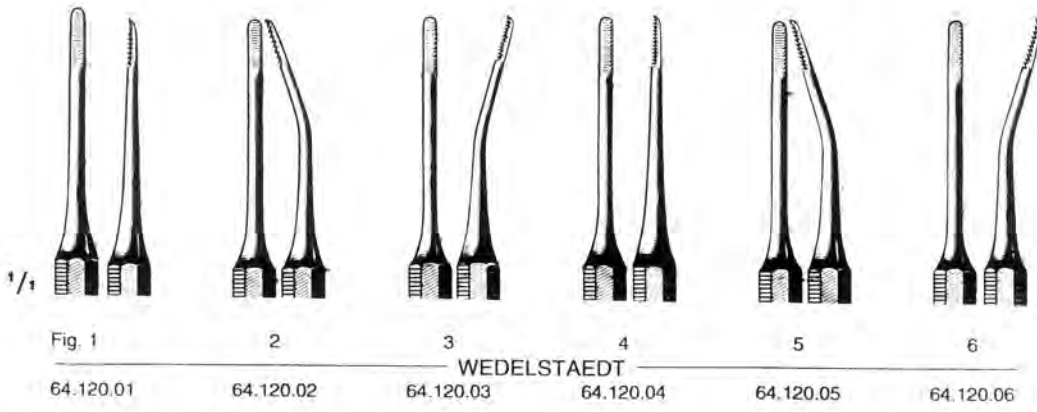

HAUBEIL  
64.137.02

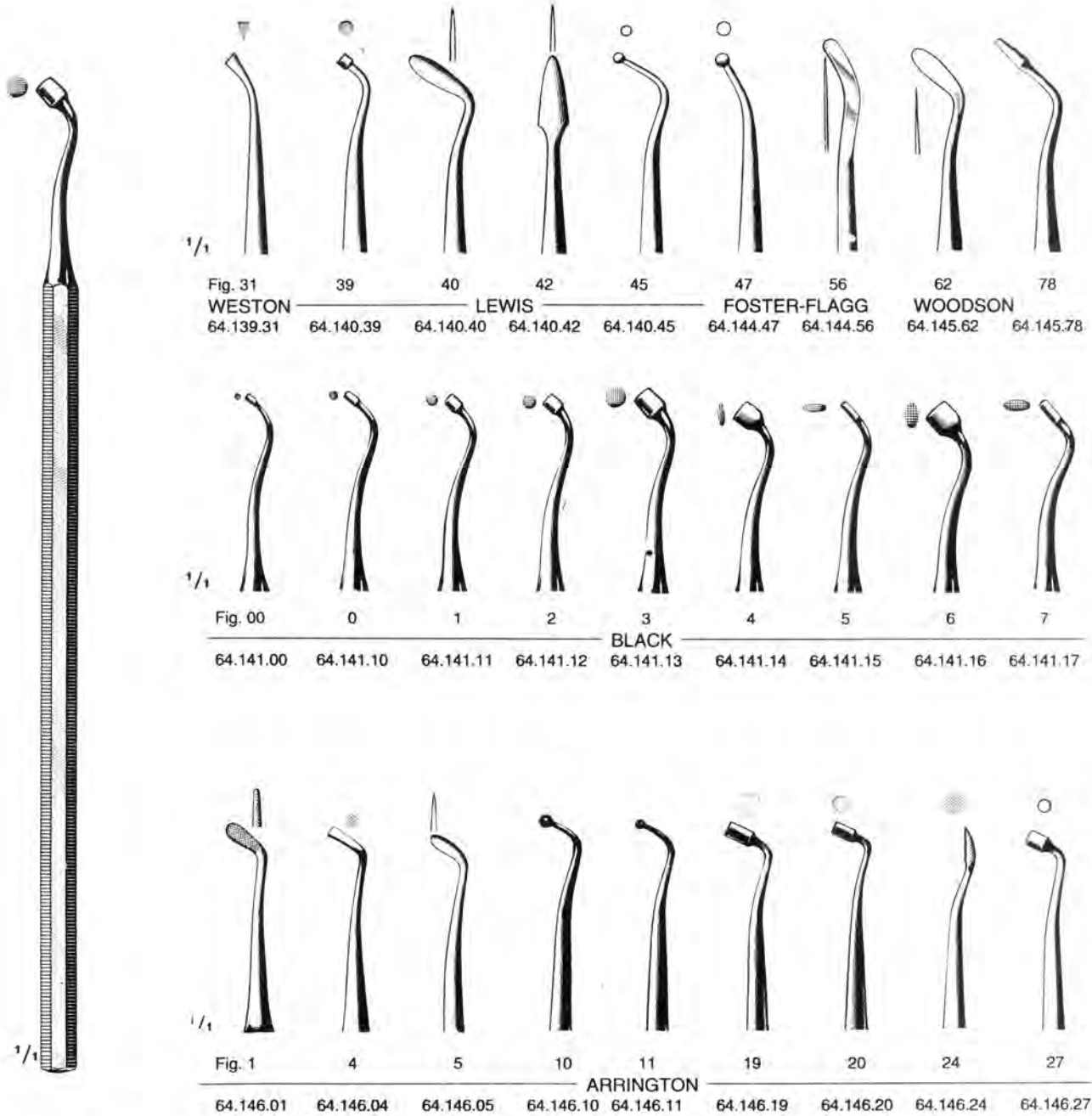



Fig. 1  
1/1

2

3

4

5

5A

6

7

MODELL >>AMALG<<

- 64.151.10
- 64.151.20
- 64.151.30
- 64.151.40
- 64.151.50
- 64.151.51
- 64.151.60
- 64.151.70

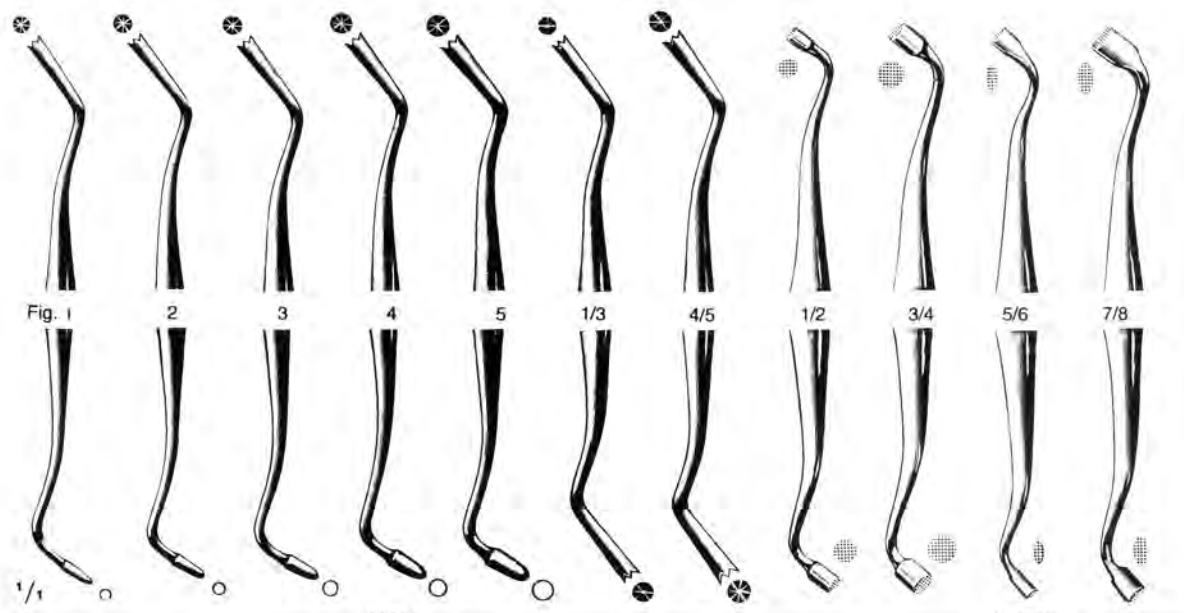

Fig. 1  
1/1

2

3

4

5

1/3

4/5

1/2

3/4

5/6

7/8

MALL

HAUBEIL

- 64.161.01
- 64.161.02
- 64.161.03
- 64.161.04
- 64.161.05
- 64.161.13
- 64.161.45
- 64.171.12
- 64.171.34
- 64.171.56
- 64.171.78

Instruments for Amalgam, Gutta - Percha & Cement  
 Instrumentos para amalgama, gutapercha y cemento  
 Instrumente für Amalgam, Gutta percha und Zement

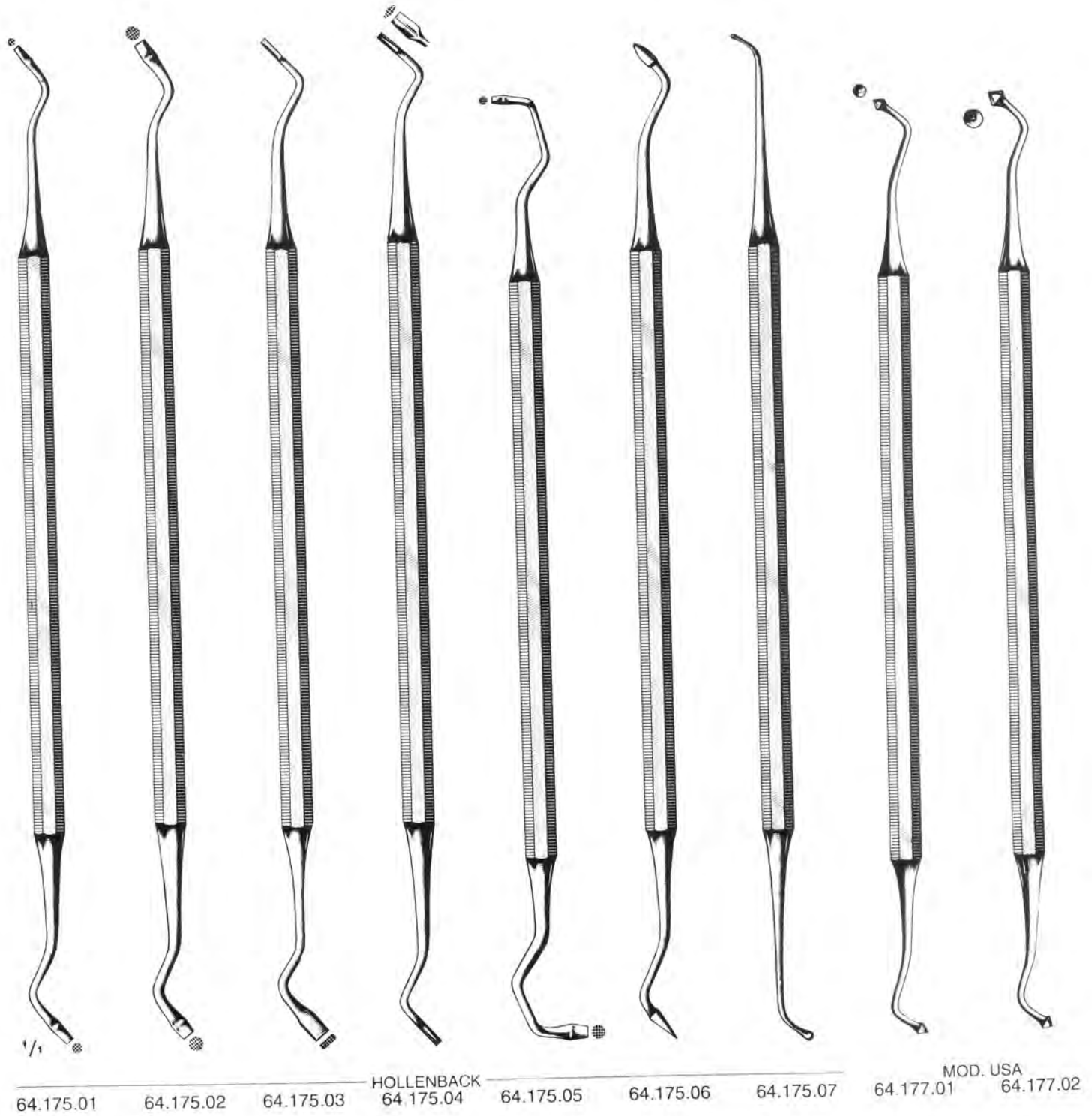



1/4  
64.187.05  
PAIR



64.189.05  
PAIR



1/4  
64.185.01



64.187.01



64.189.01

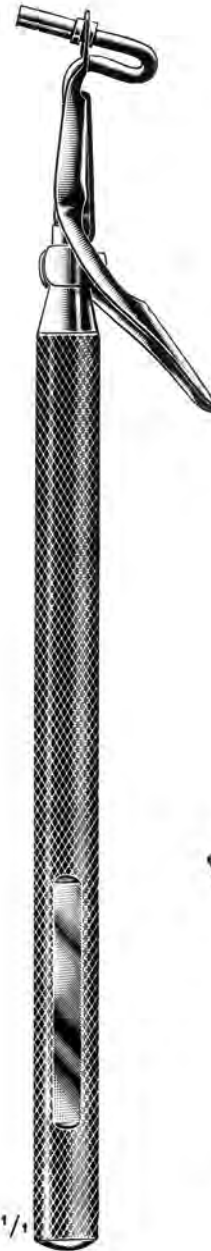

1/4  
IVORY  
64.206.17



1/4  
IVORY  
64.206.21

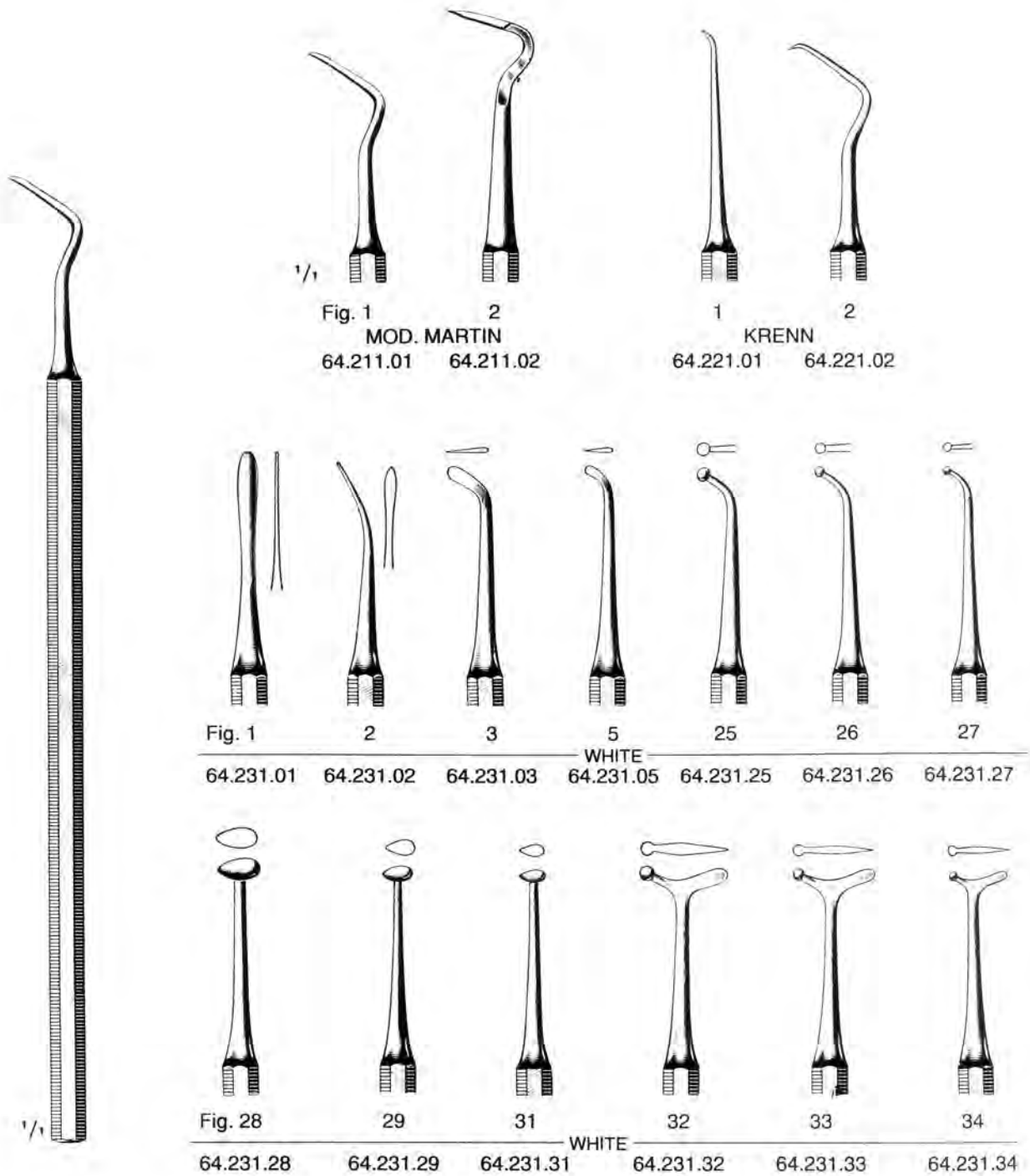



64.251.00

64.251.01

MOD. >>SPATULA<<

64.251.02

64.251.03

64.251.04



64.251.05

64.251.06

MOD. >>SPATULA<<

64.251.07

64.251.08

64.251.09



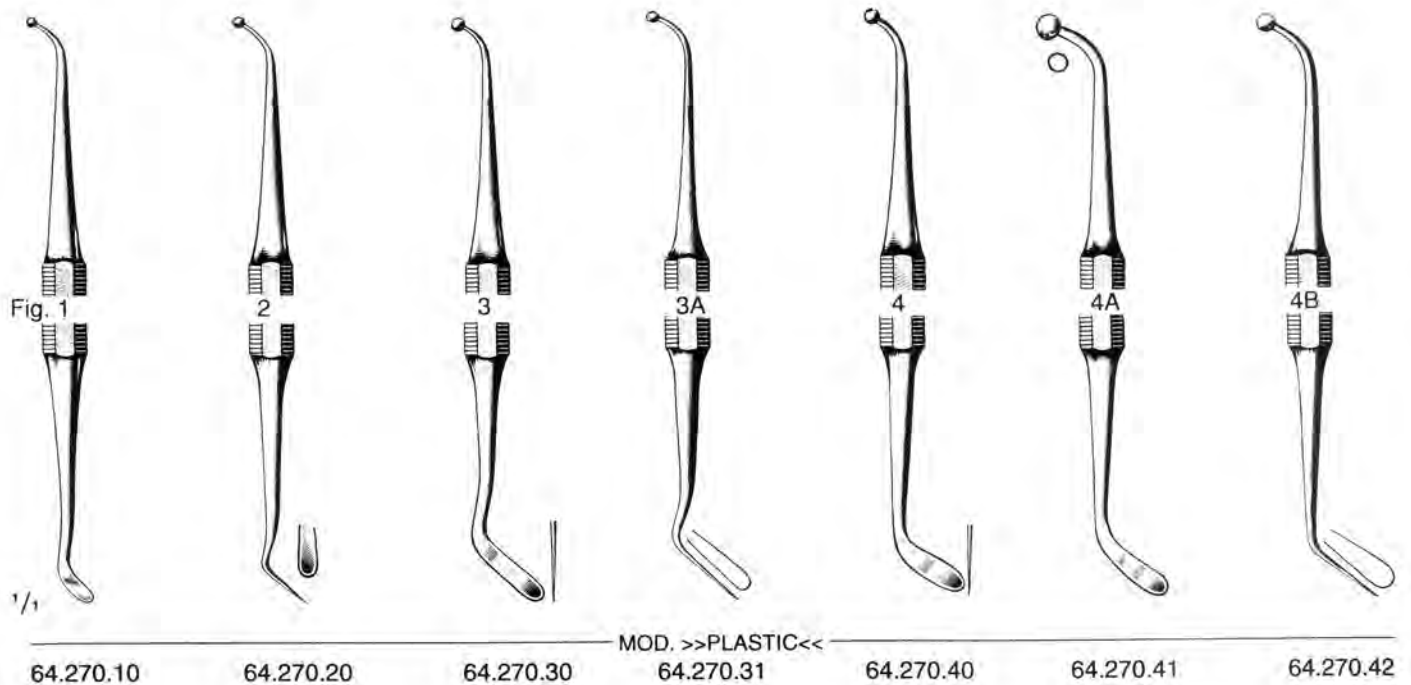
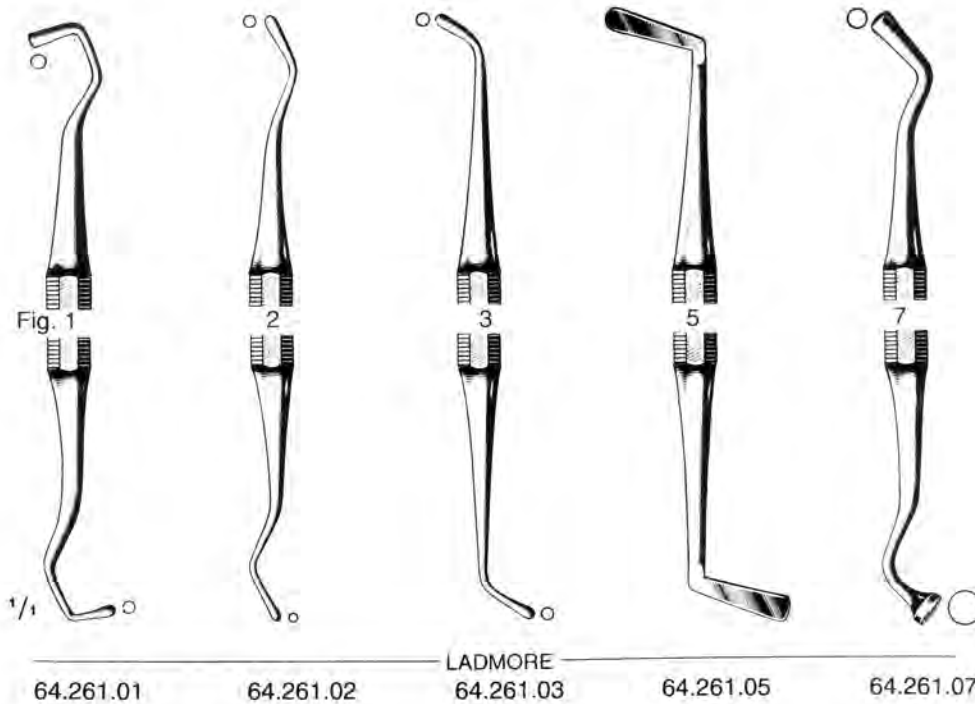



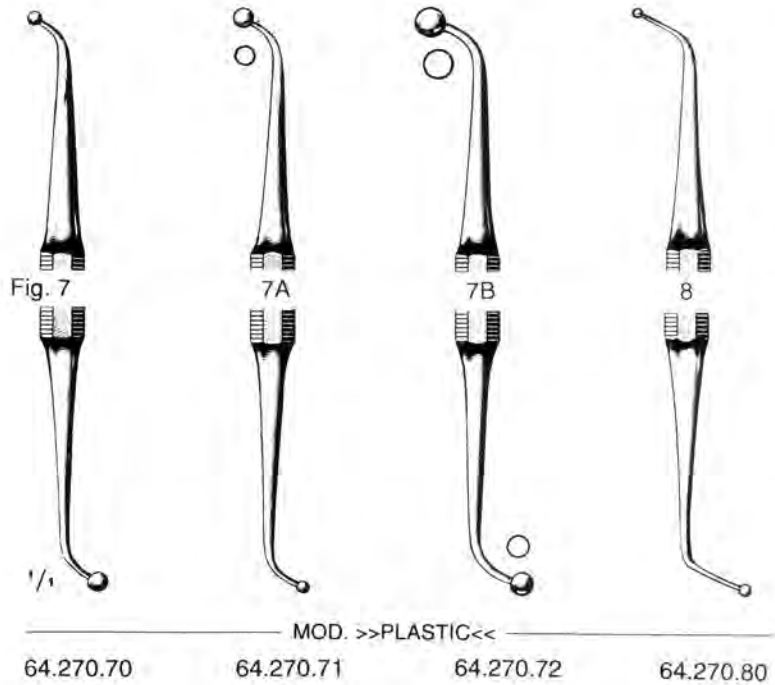
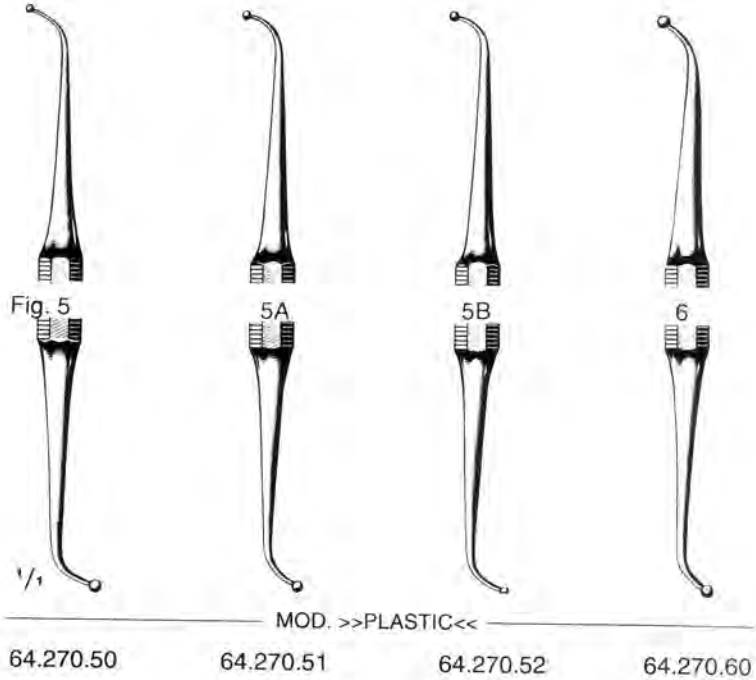
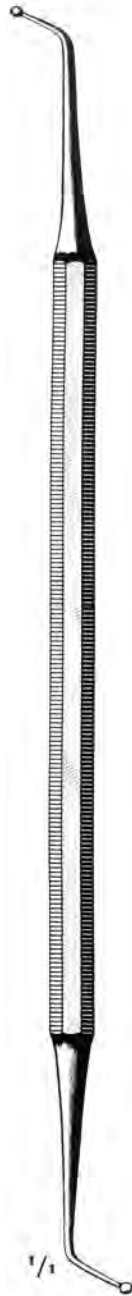

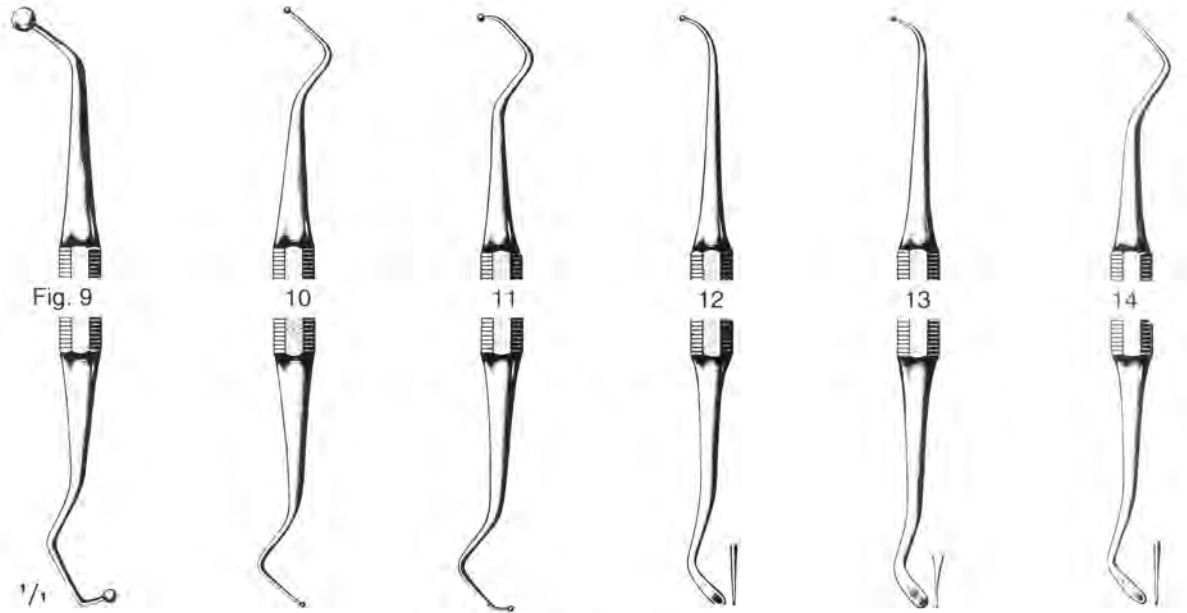

64.270.90      64.271.10      MOD. >>PLASTIC<<      64.271.11      64.271.12      64.271.13      64.271.14

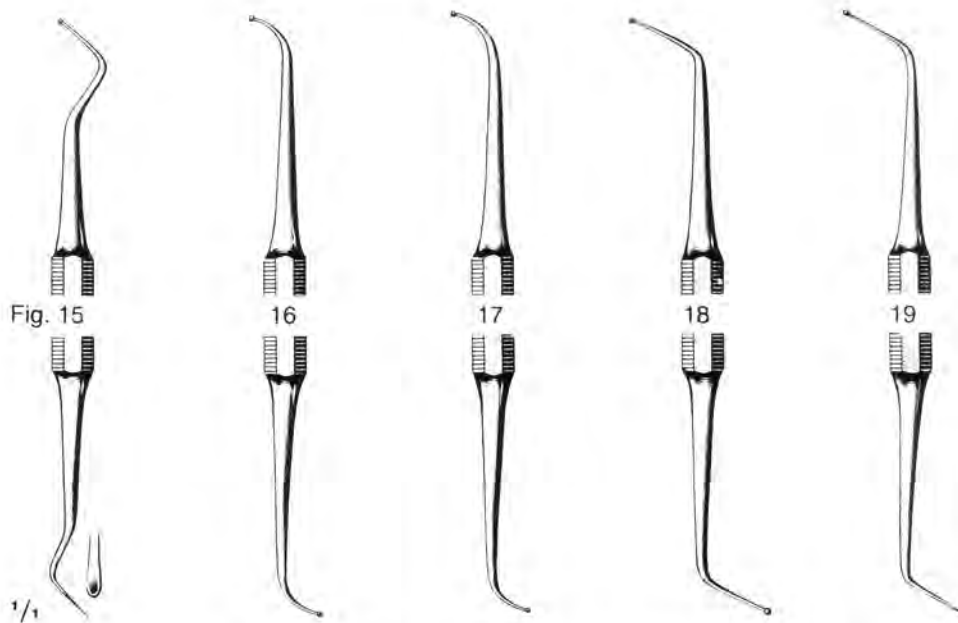

64.271.15      64.271.16      64.271.17      MOD. >>PLASTIC<<      64.271.18      64.271.19

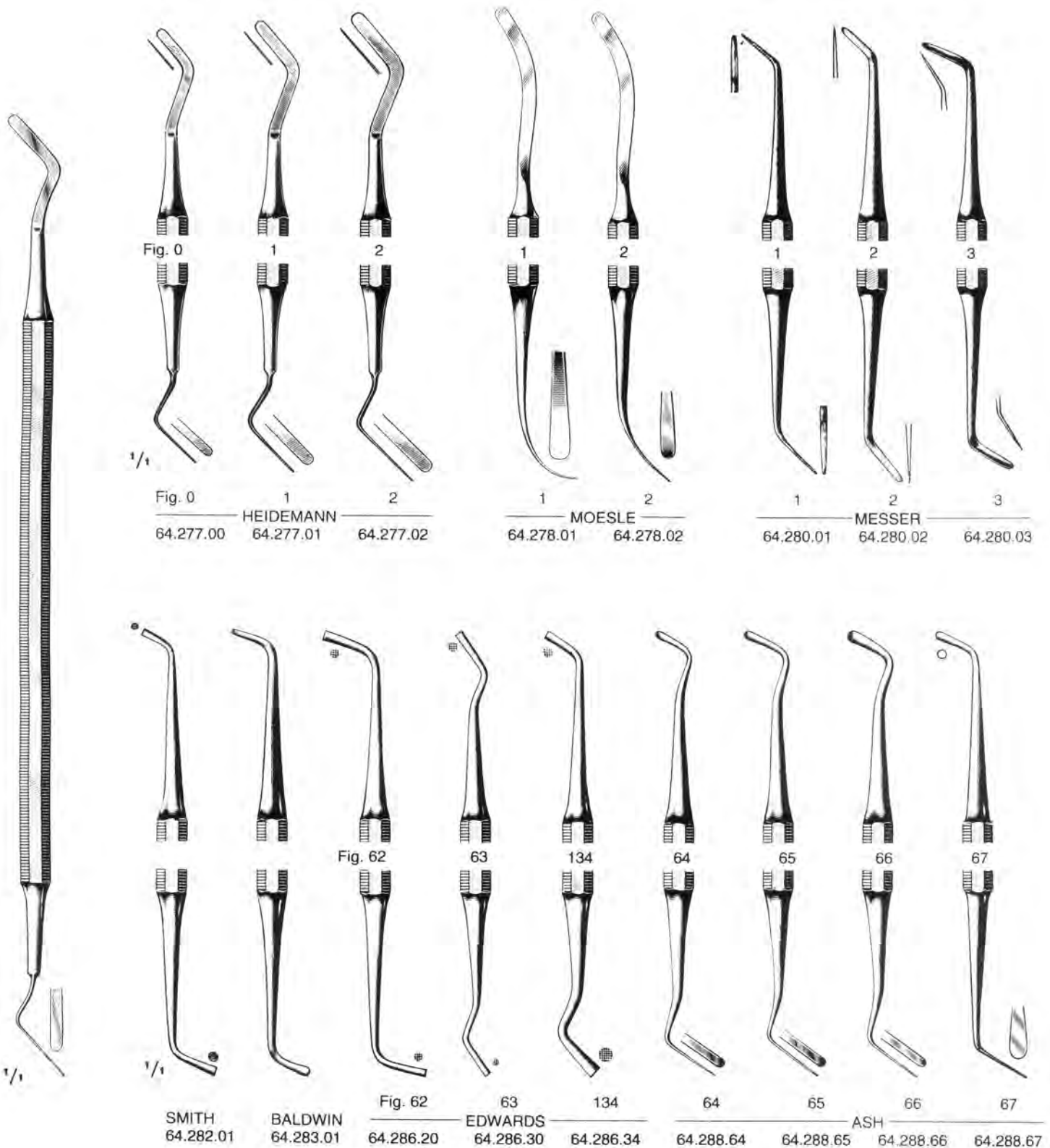

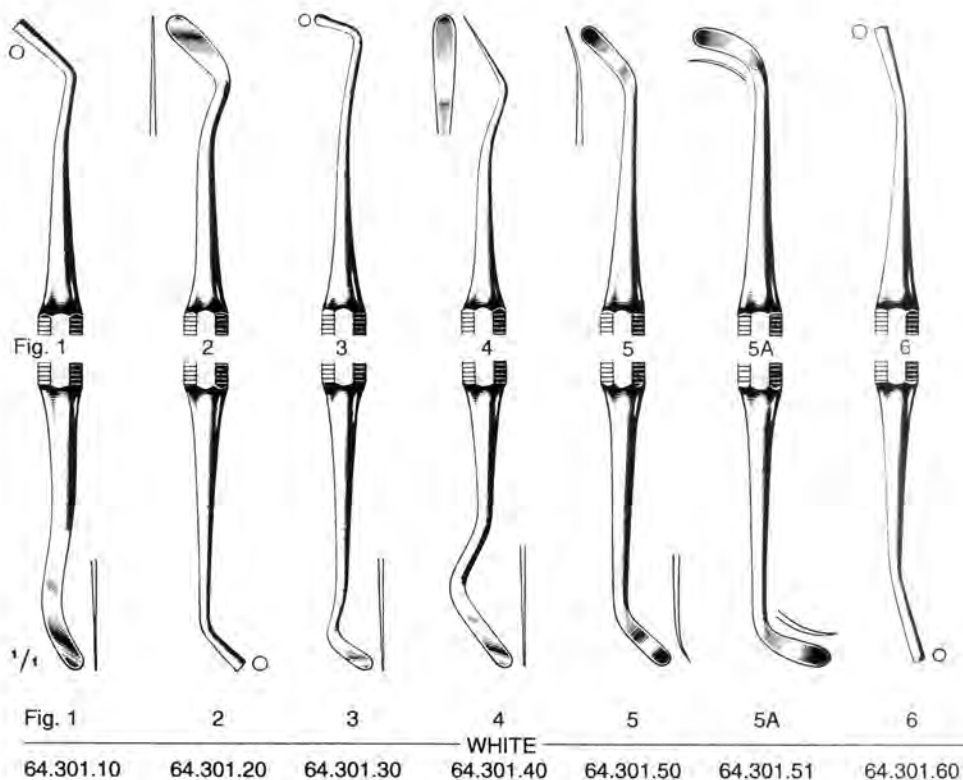
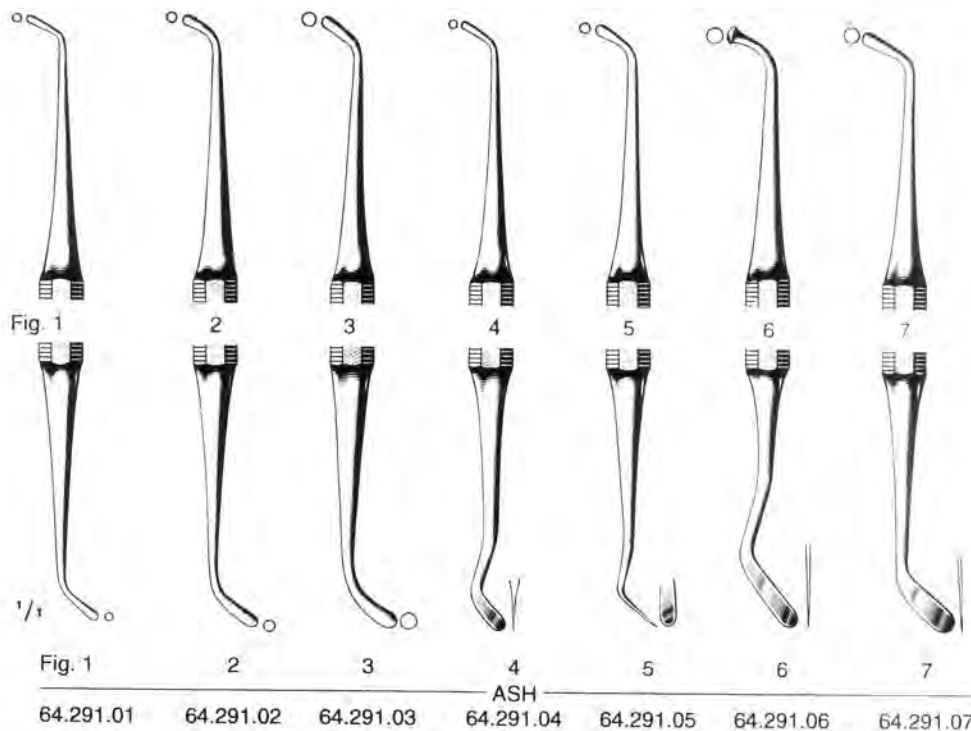
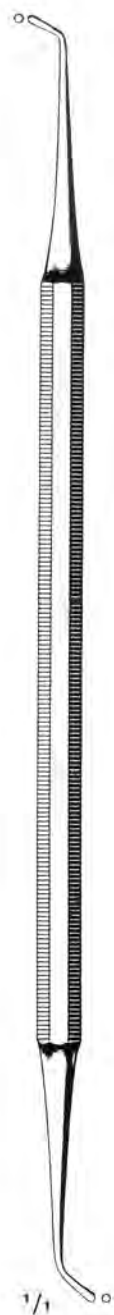

Plastic Filling Instruments  
Instrumentos para obturaciones plásticas  
Instrumente für plastische Füllungen

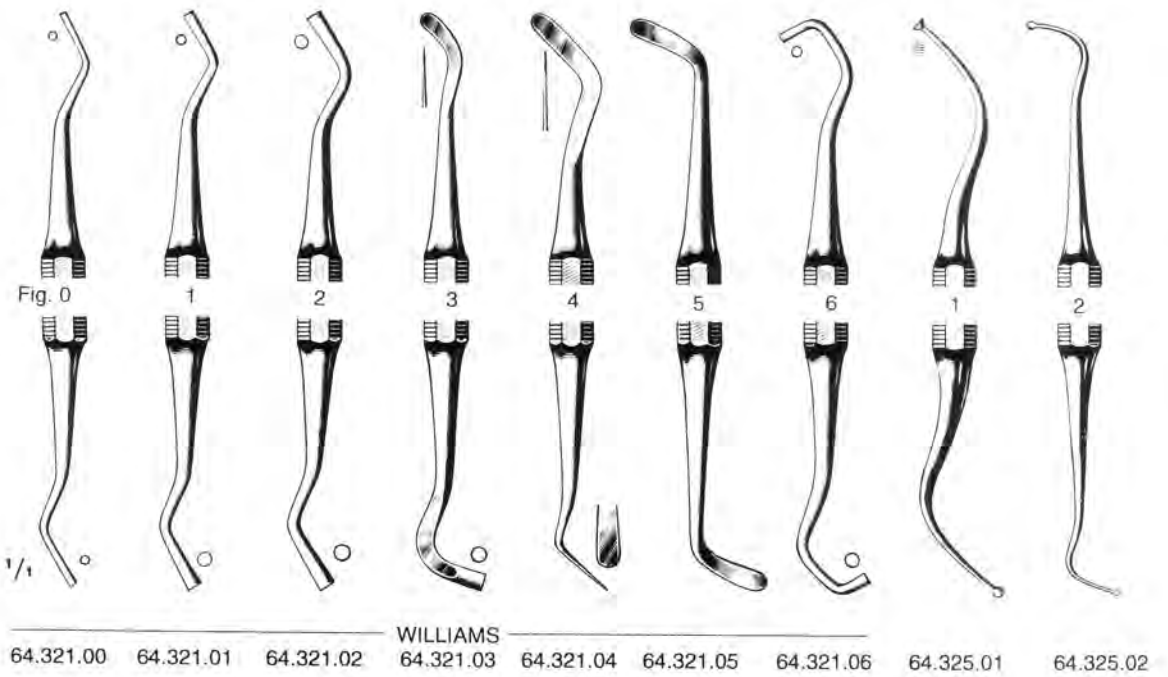
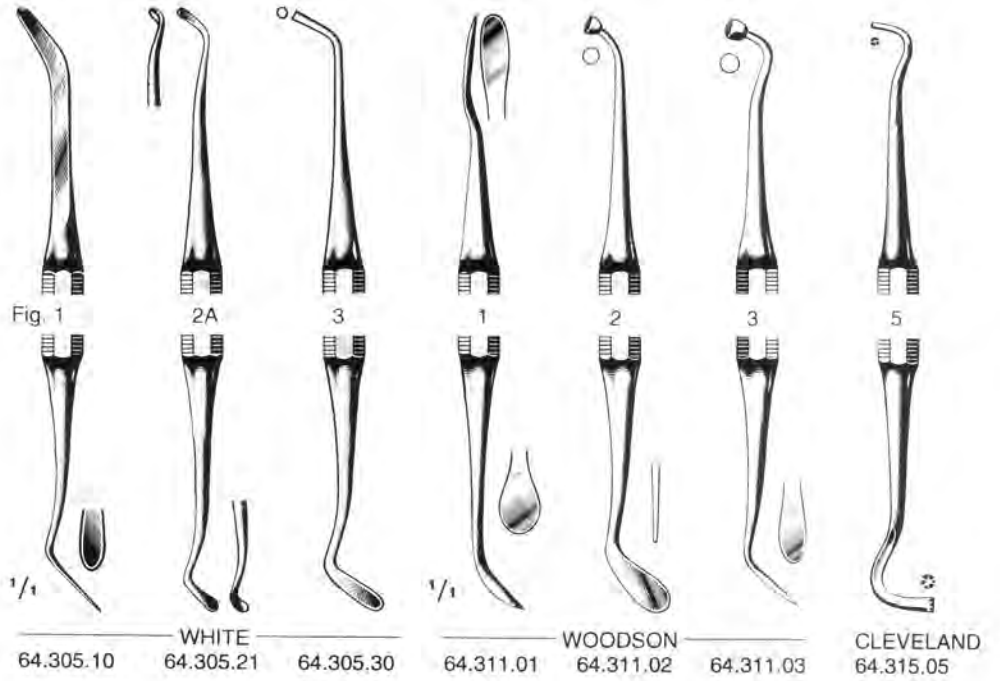
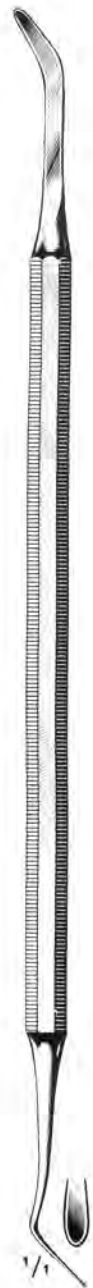

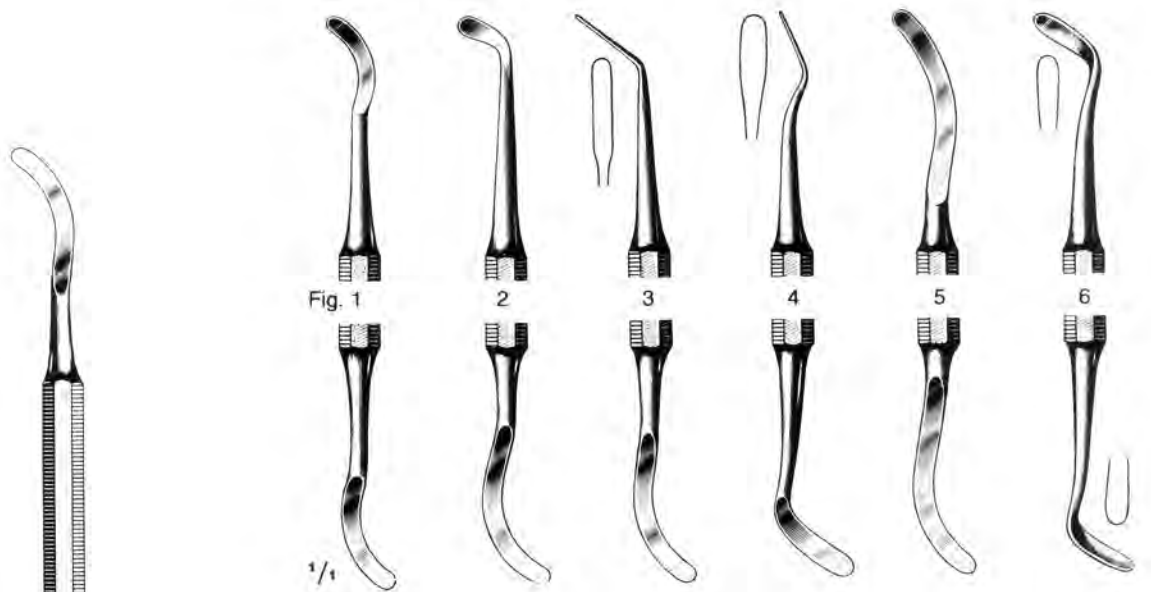

Fig. 1

2

3

4

5

6

1/1

LINSEMANN

64.341.01    64.341.02    64.341.03    64.341.04    64.341.05    64.341.06

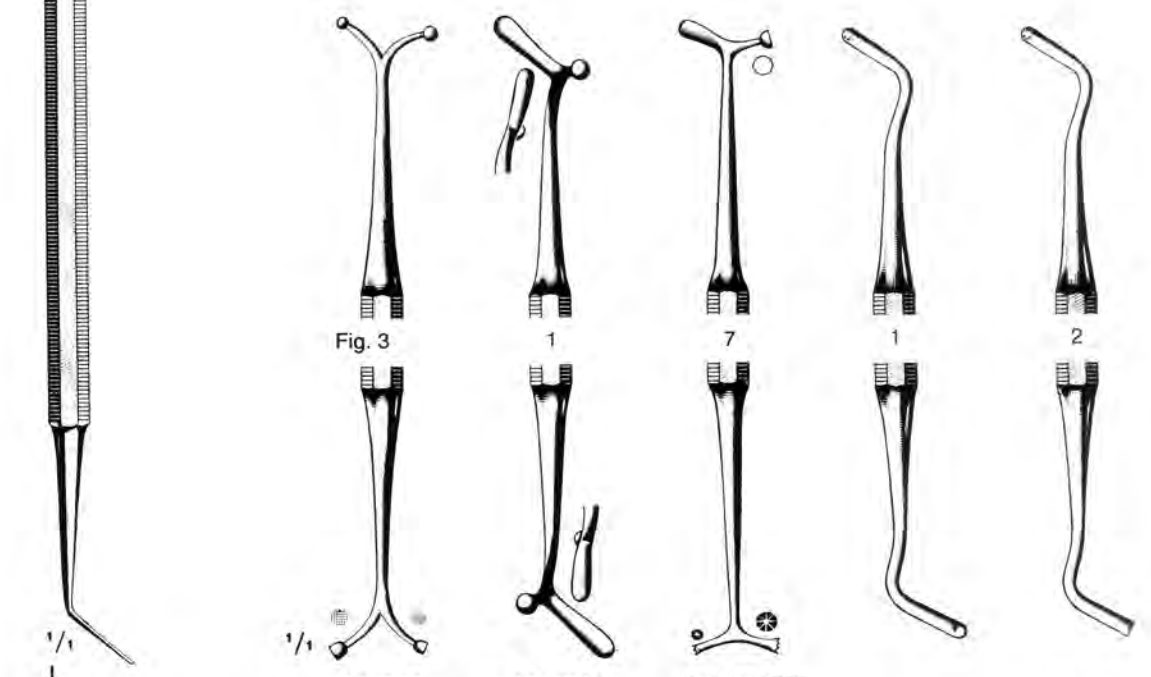

Fig. 3

1

7

1

2

1/1

VAJNA  
64.345.03

VAJNA  
64.347.01

BENNET  
64.349.07

64.351.01

64.351.02

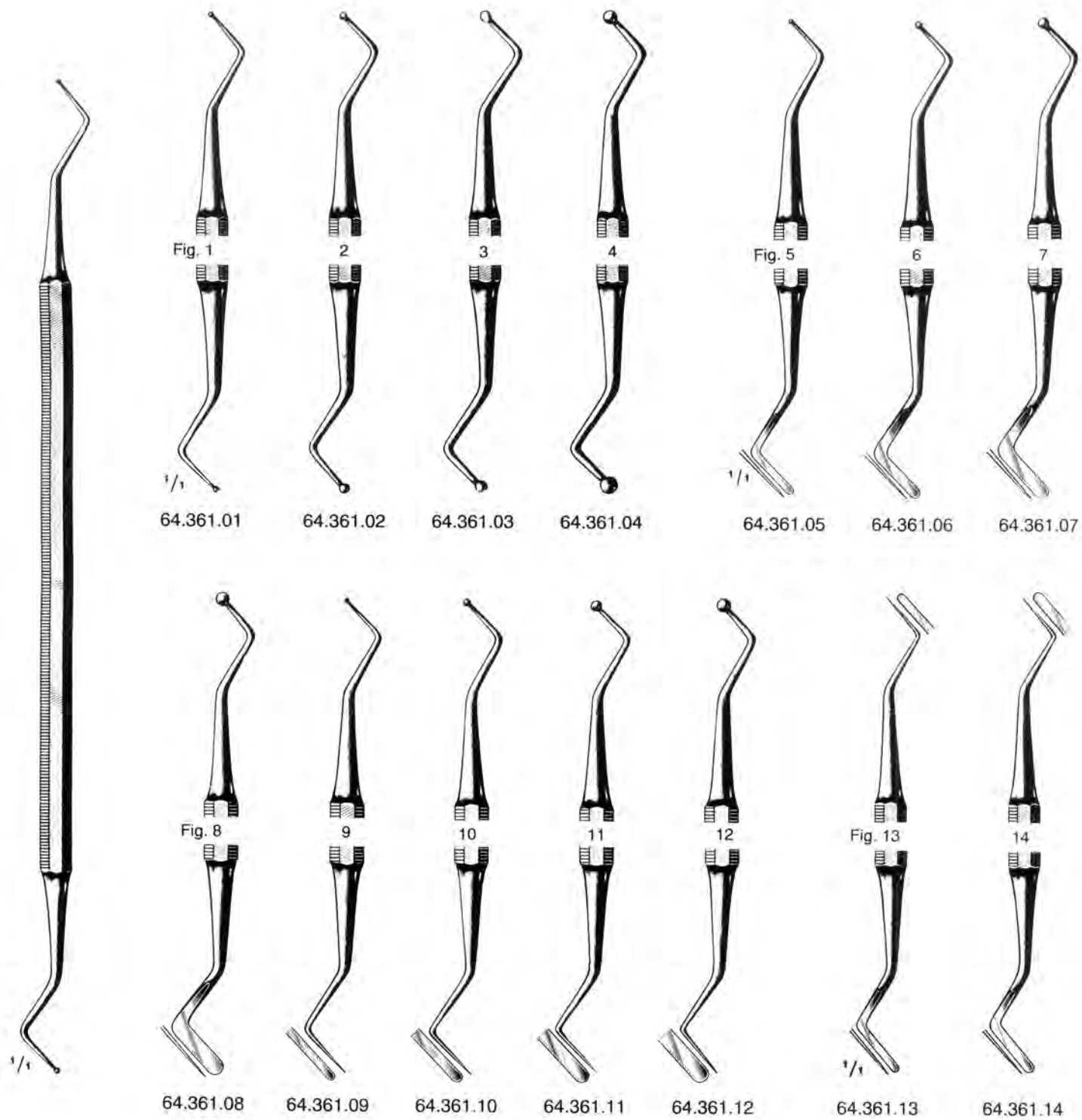

Axial Filling Instruments  
 Instrumentos Axial para obturaciones plásticas  
 Axial Füllungsinstrumente

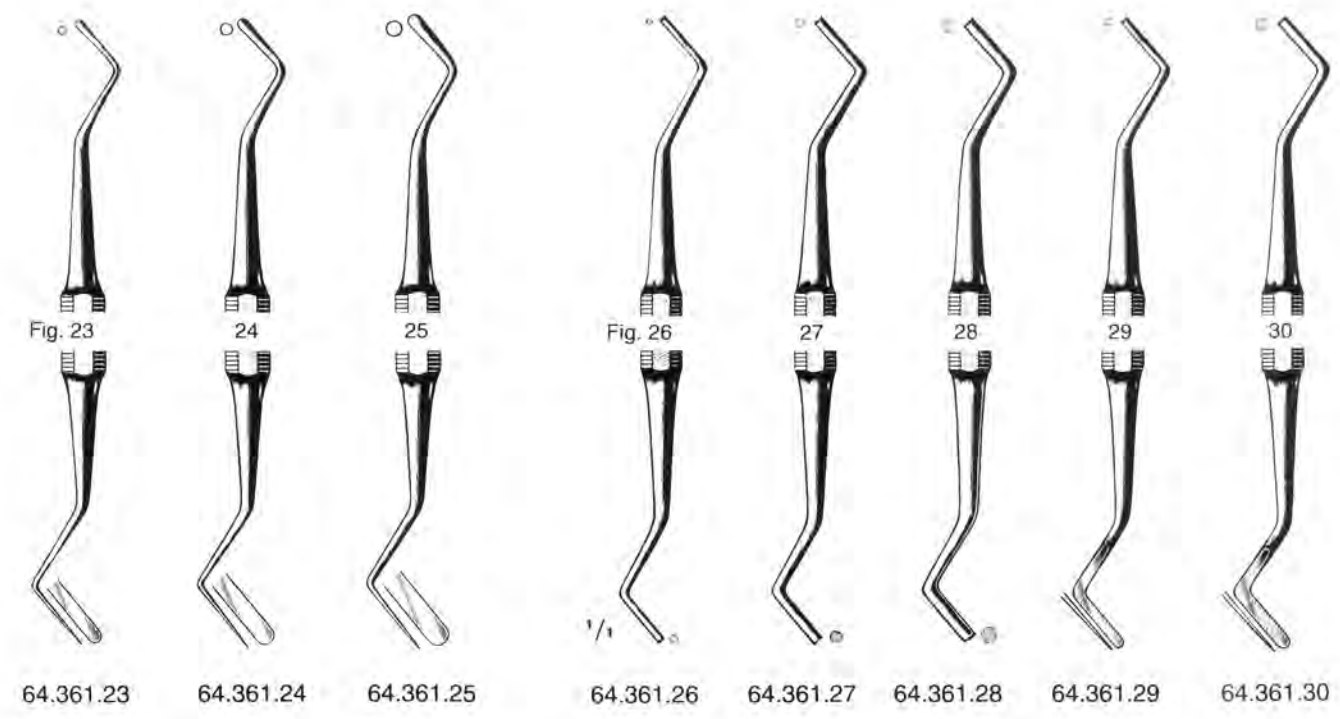
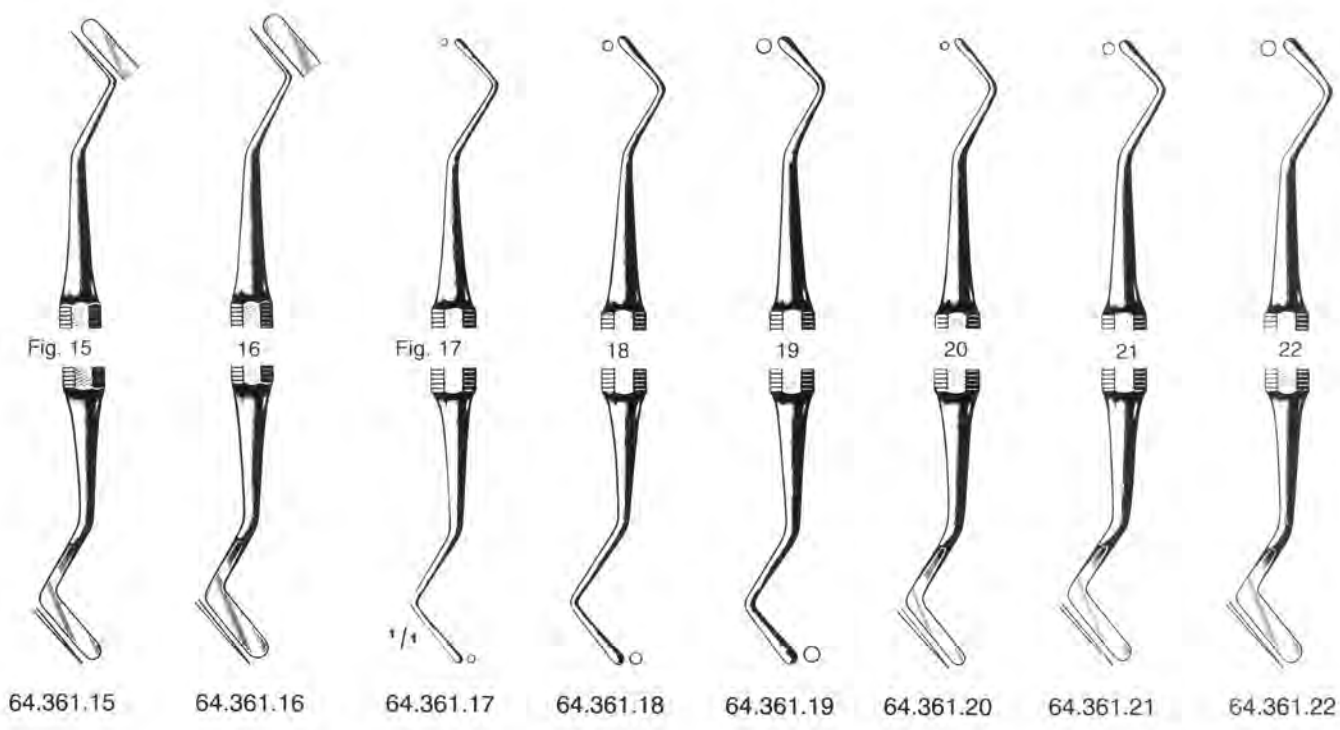



Axial Filling Instruments  
Instrumentos Axial para obturaciones plásticas  
Axial Füllungsinstrumente

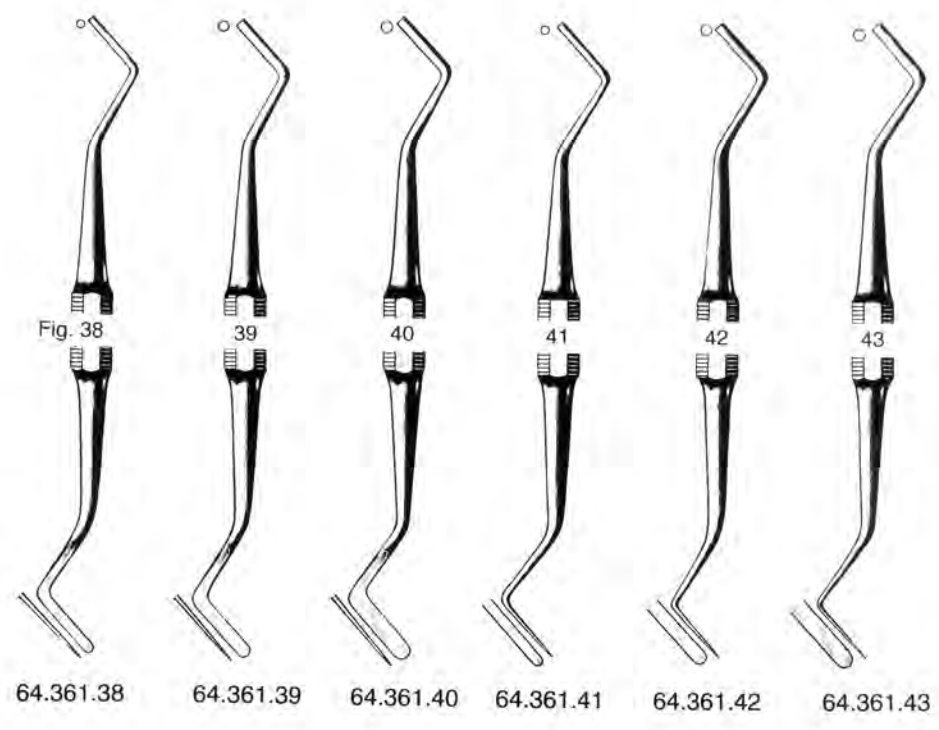
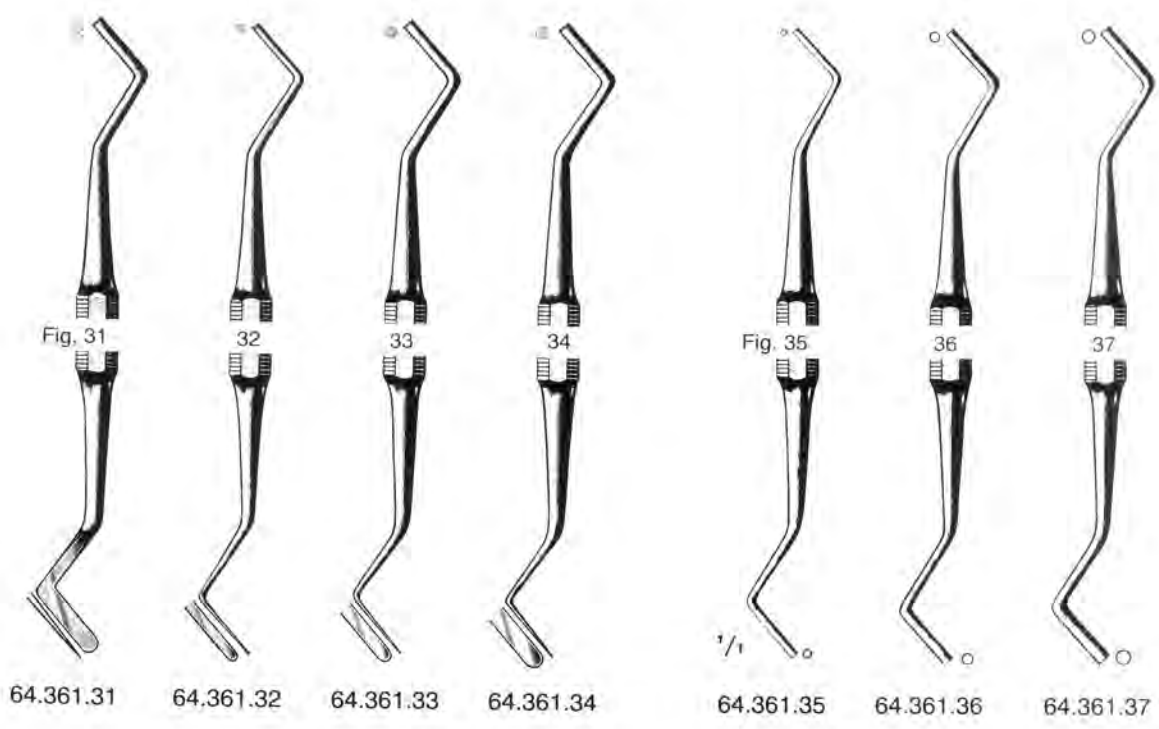

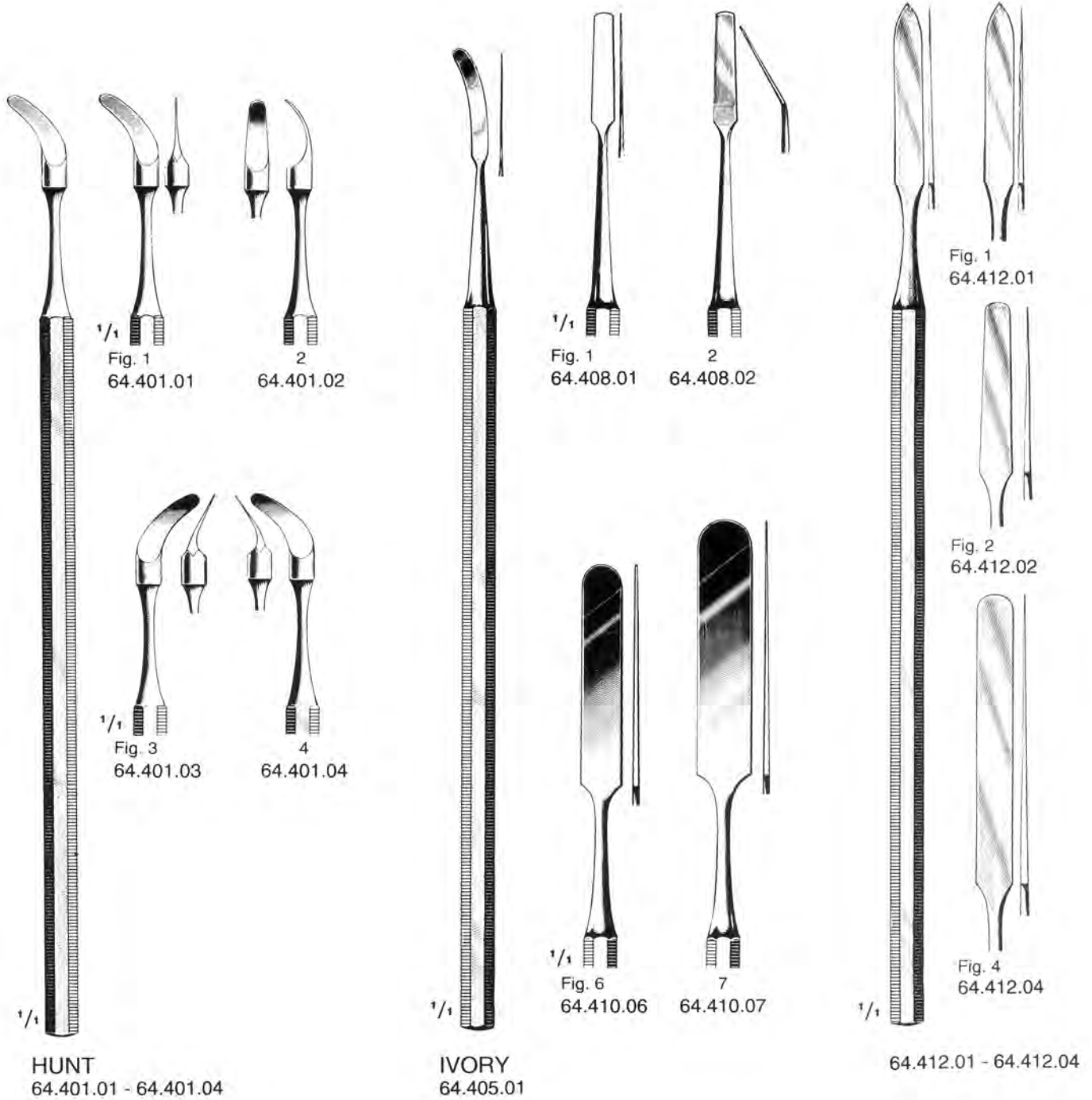

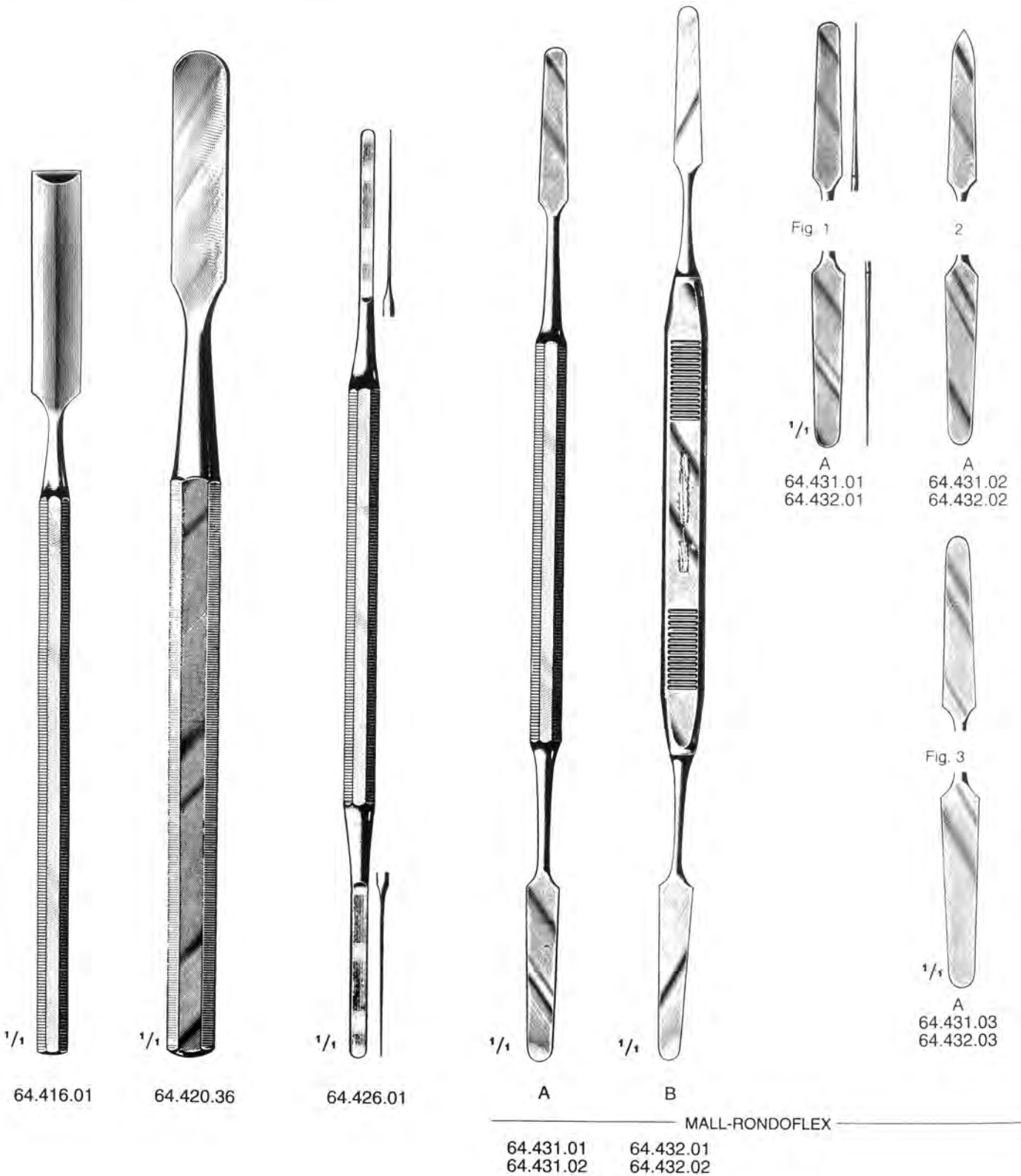

Cement Spatulas - Silicate Spatulas  
 Espátulas para cemento y silicato  
 Zementspatel - silikatspatel

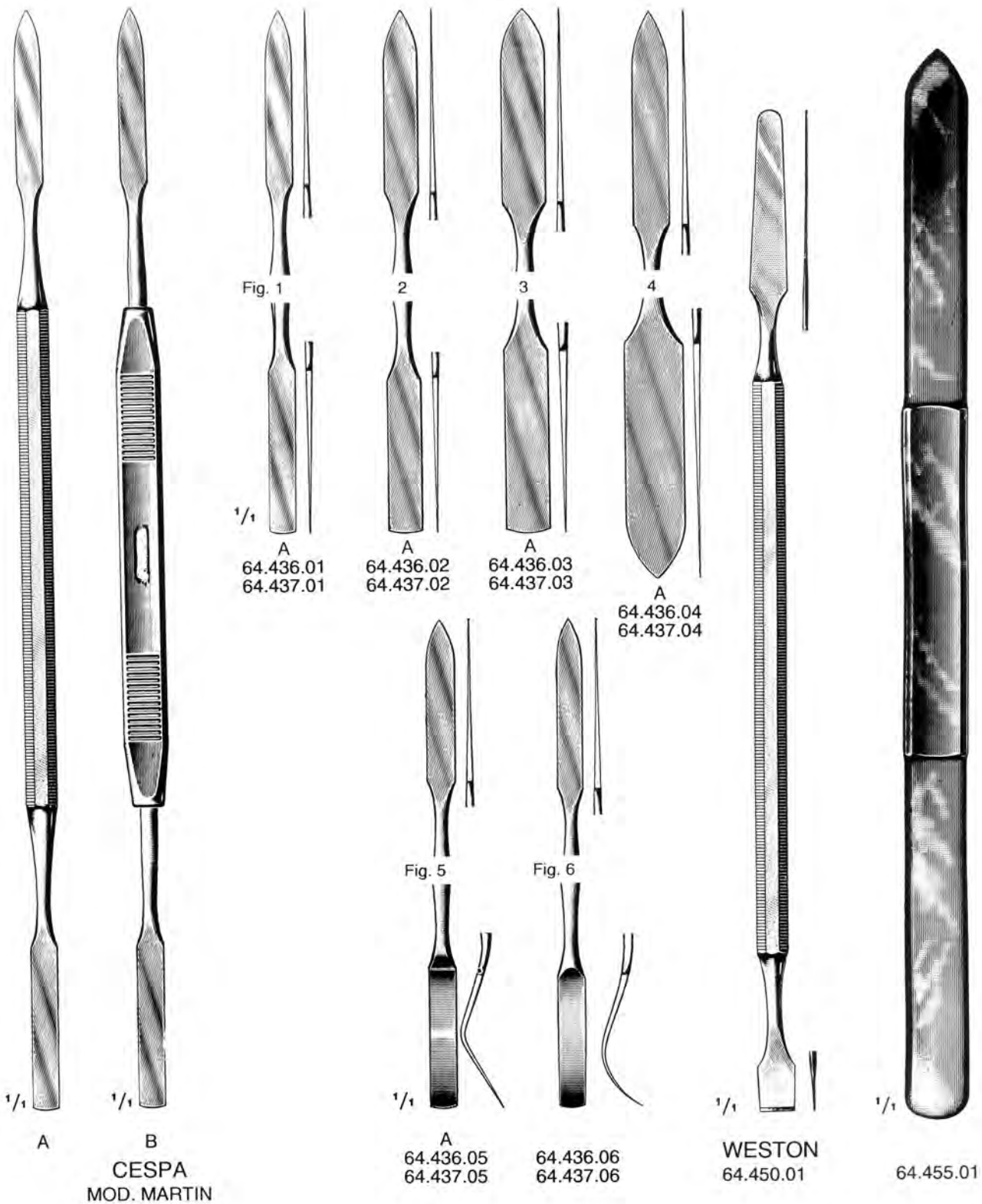

Separators and Matrix Retainers  
Separadores y Porta – matrices  
Separatoren, Matritzenspanner



IVORY  
64.460.01



IVORY  
64.465.01



IVORY  
64.467.01



IVORY  
64.468.01



IVORY  
64.480.05 5 mm  
64.480.07 7 mm



IVORY  
64.481.05



DIDNER  
64.482.05



TOFFLEMIRE  
Universal  
64.483.05



TOFFLEMIRE  
Junior  
64.484.00



TOFFLEMIRE  
Senior  
64.485.00

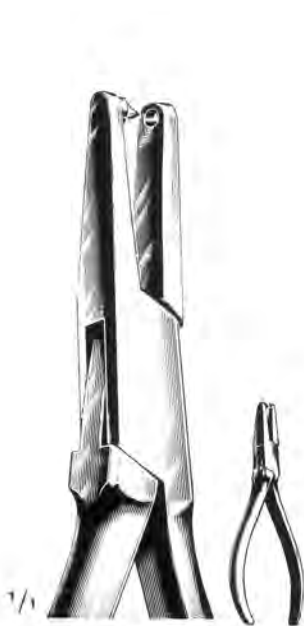

**TUTTLE**  
 64.490.15  
 15 cm / 6"



**AINSWORTH**  
 64.500.16  
 16 cm / 6 1/4"



**IVORY**  
 64.502.17  
 17 cm / 6 3/4"

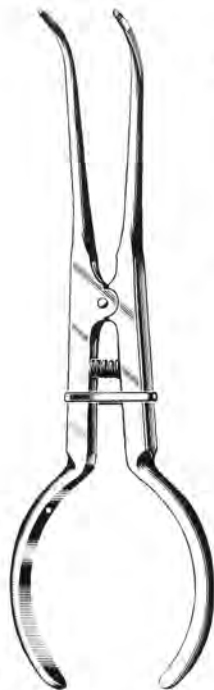

64.503.17  
 64.505.17  
 17 cm / 6 3/4"

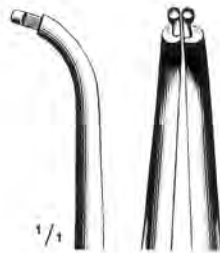

**STOCKES**  
 64.503.17



**PALMER**  
 64.505.17

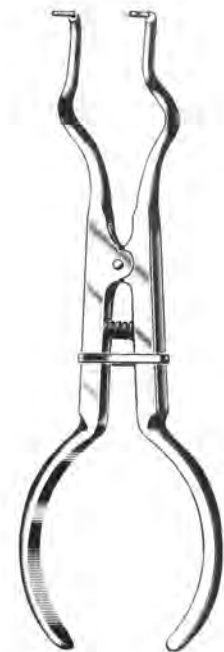

**BREWER**  
 64.513.17  
 17 cm / 6 3/4"



IVORY  
64.514.17  
17 cm / 6¾"

Crown and Band Remover  
Arranca - Coronas y bandas  
Kronen - und Bandabnehmer



IVORY  
64.525.17  
17.5 cm / 7"

Band Pusher  
Adaptador de cuitas  
Bandon drücker



64.530.17  
17.5 cm / 7"

Band Setter  
Empujador para bandas  
Bandanfretzer



BAADE  
64.600.00



MERSHAM  
64.605.00



64.610.00

Molar Clamps – Wingless



64.515.26



64.515.28



64.515.30



64.515.31



64.515.51

Bicuspid Clamps – Wingless



64.515.27



64.515.29



64.515.60

Molar Clamps - Winged



64.518.200



64.518.201



64.518.202



64.518.203



64.518.204



64.518.205



Molar Clamps – Wingless



64.518.30



64.518.31



64.518.51



64.518.138



64.518.139

Molar Clamps – Wingless



64.518.15



64.518.18



64.518.24



64.518.25



64.518.26



64.518.28

Biscupid Clamps - Winged



64.518.206



64.518.207



64.518.208



64.518.209

Biscupid Clamps - Winged



64.518.22



64.518.27



64.518.29

Lateral Clamps – Winged



64.518.210



64.518.211



64.518.212

Crown Slitter  
Pinza para cortar coronas  
Kronenaufschneidezange



64.600.16

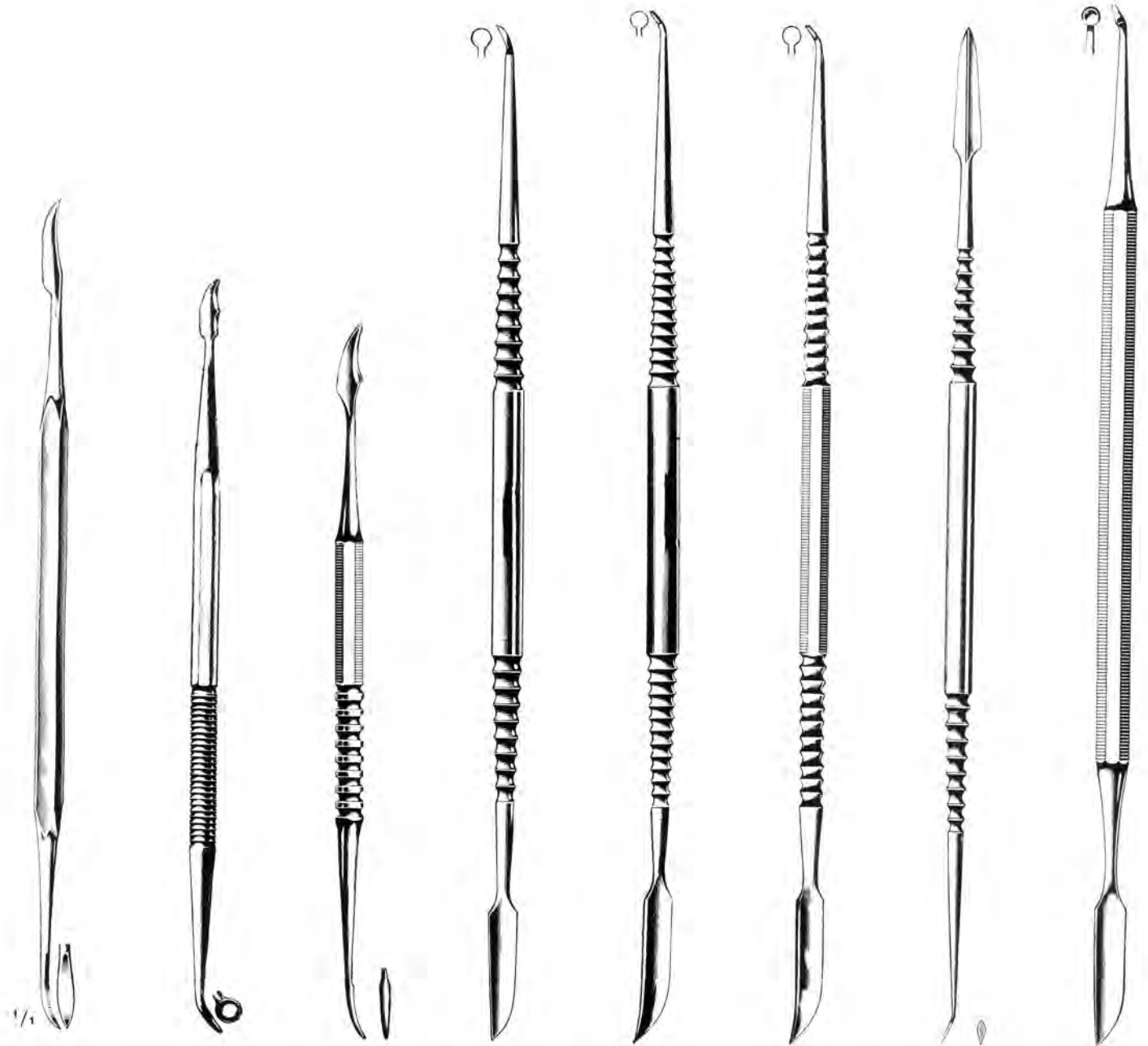

HYLIN  
66.392.01

ZAHLE  
66.394.01

ZAHLE  
66.395.01

LE CRON  
66.401.01

LE CRON  
66.402.01

LE CRON  
66.403.01

LE CRON  
66.404.01

LE CRON  
66.405.01

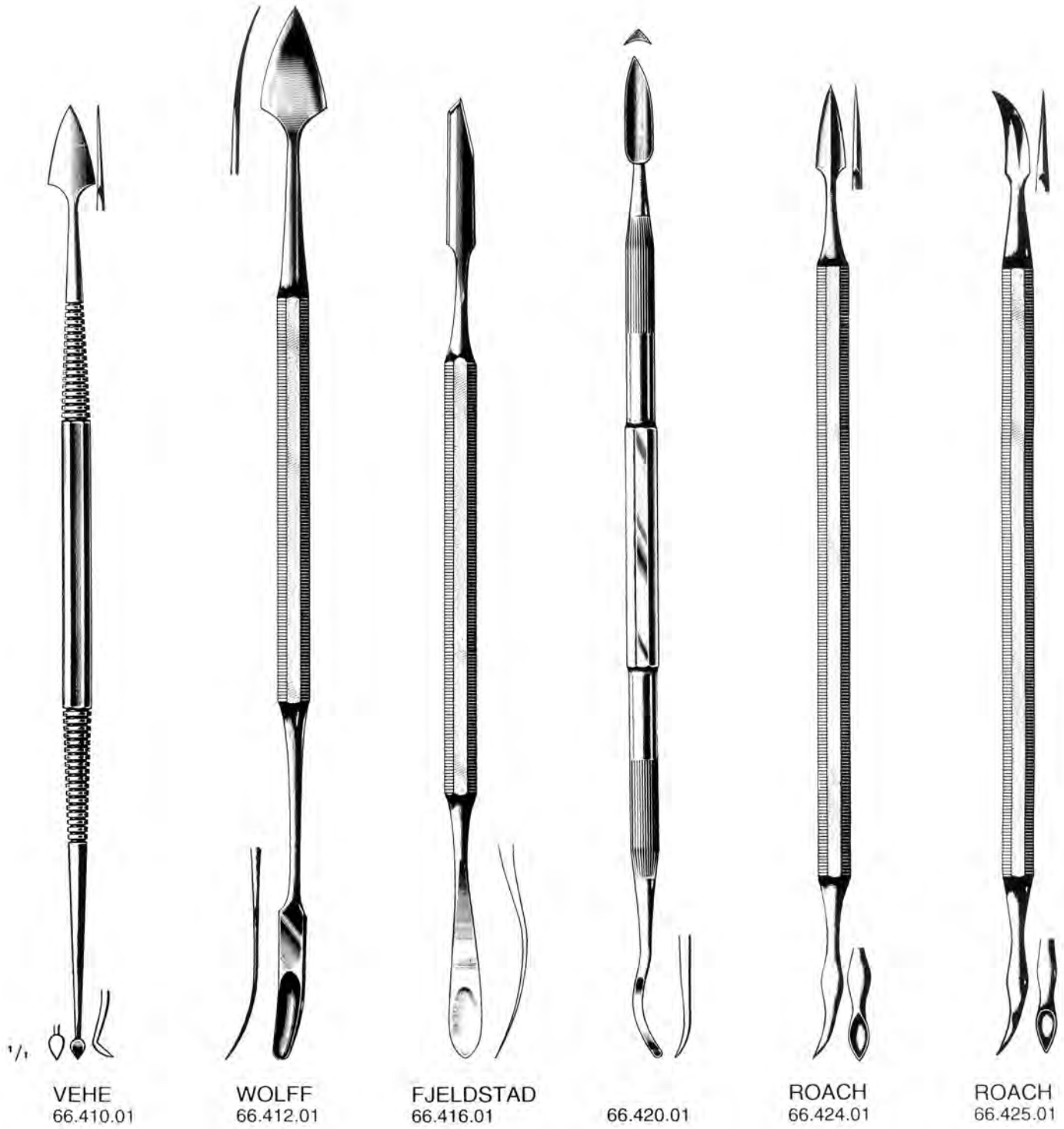

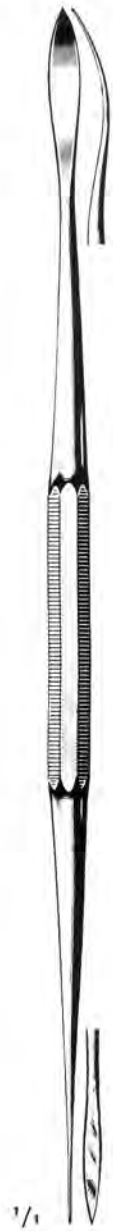

RIEGNER  
66.428.01

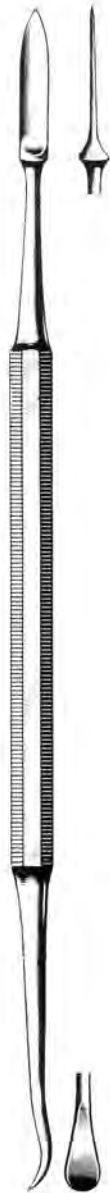

EVANS  
66.430.01

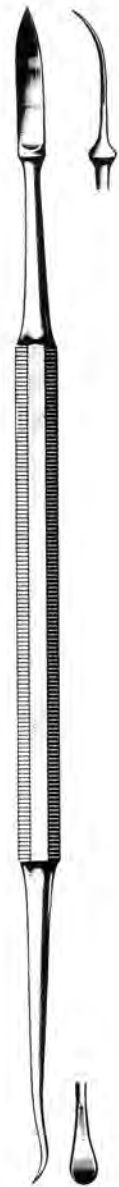

EVANS  
66.431.01



Fig 1  
FRAHM  
66.435.01

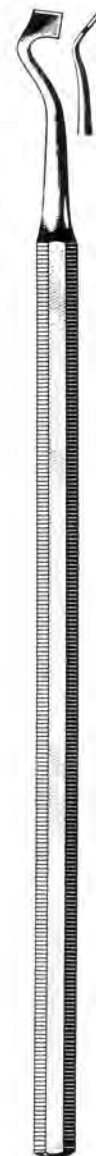

2  
FRAHM  
66.435.02



3  
FRAHM  
66.435.03



ERMERT  
66.450.01



ERMERT  
66.451.01

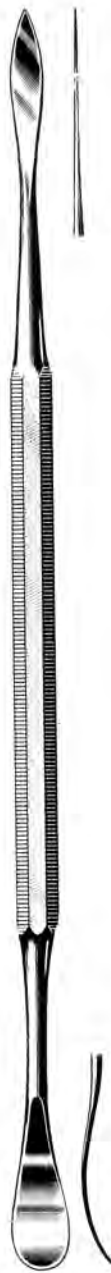

BEALE  
66.462.01  
Mod. 7A

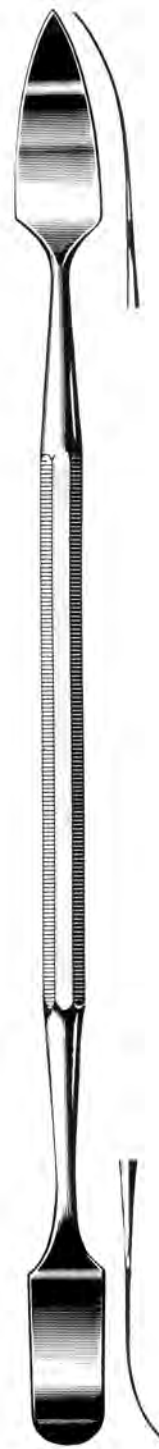

GRITMAN  
66.465.01  
Mod. 31

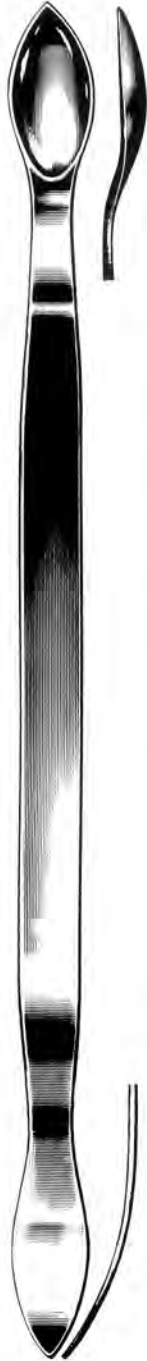

66.470.01  
Mod. 5



**FAHNENSTOCK**  
66.482.13 13 cm / 5"  
66.482.17 17.5 cm / 7"

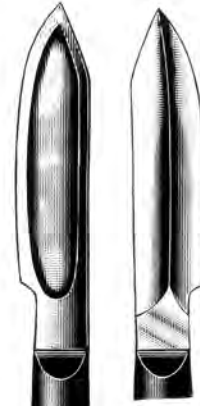

**LESSMANN**  
66.484.13  
66.484.17



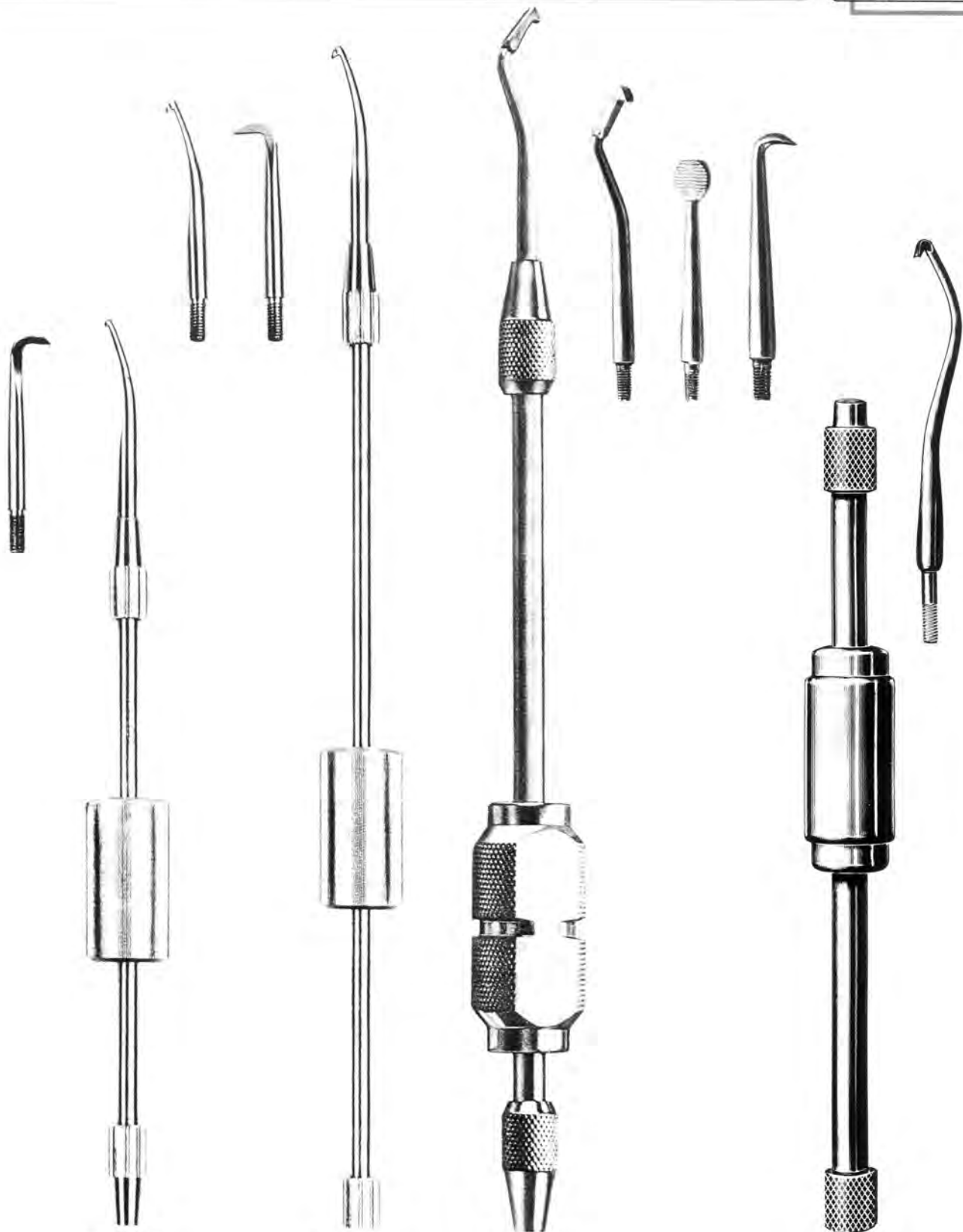

with one  
 attachment  
 66.501.01

with two  
 attachment  
 66.502.01

with three  
 attachment  
 66.503.01

MILLER  
 66.580.01



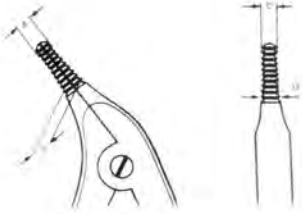

**BOHM**  
66.510.14  
14.5 cm / 5½"



**BOHM**  
66.512.11  
11.5 cm / 4½"



66.517.15  
15 cm / 6"



66.519.15  
15 cm / 6"

Crown Slitter  
Pinzas para cortar Coronas  
Kronenauf Schneidezange



MONFORT  
66.590.19

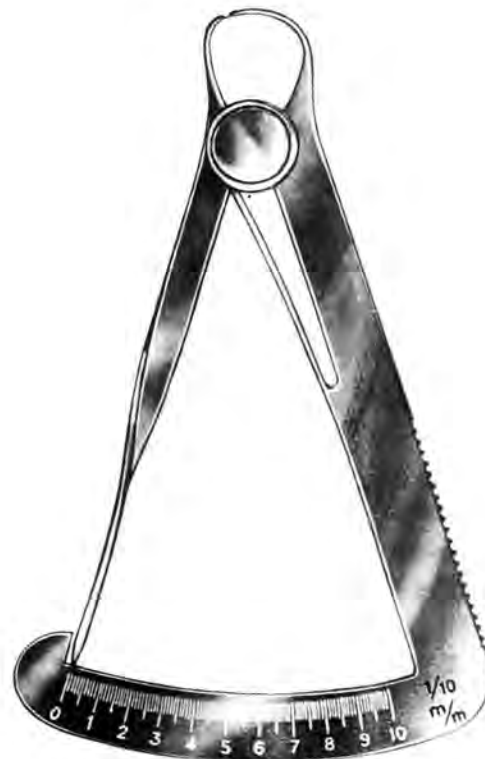

Caliper  
(for wax – pour cire – für – wachs)  
66.595.00

(for metal – pour metal – für – metal)  
66.600.00

Flat Nose Pliers  
Alicates de picos chatos  
Flachzangen



14 cm



67.504.14



67.505.14



LANGENBECK  
14 cm



67.517.14



67.518.14



12.5 cm



67.521.13

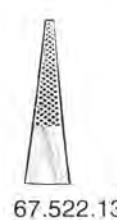

67.522.13

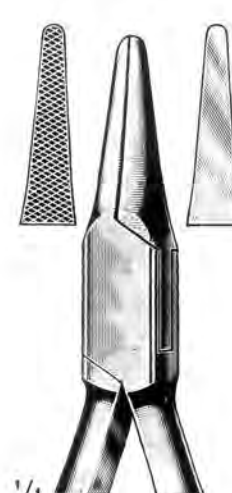

GOSLEE  
67.524.14  
14 cm

Flat and Round Nose Pliers  
 Alicates de picos chatos y redondos  
 Flach - und Rundzangen

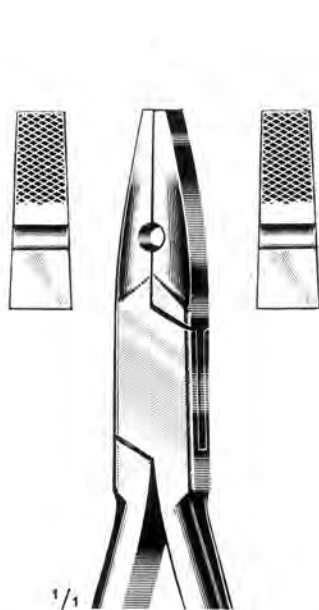

67.526.14  
14 cm

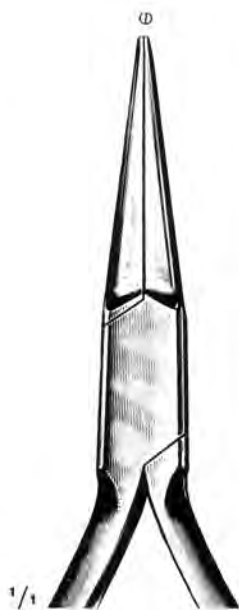

LANGENBECK  
67.534.14  
14 cm



67.536.13  
13 cm

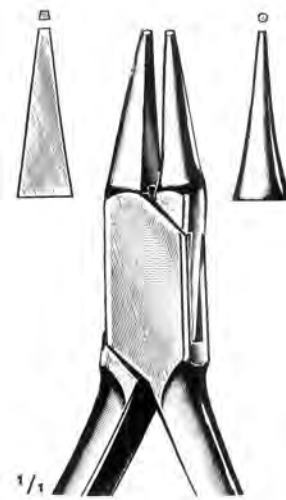

67.538.15  
15 cm



67.540.13  
13 cm



13 cm



67.542.13



67.543.13

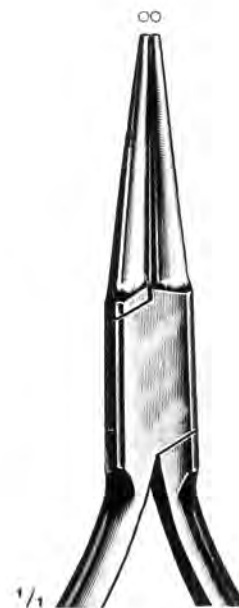

LANGENBECK  
67.544.14  
14 cm



INSTRUMENTS

Flat and Round Nose Pliers, End and side Nippers  
Alicates de picos chatos y redondos, Alicates cortantes  
Flach -, Rund - und Zwickzangen



DUMONT  
11 cm

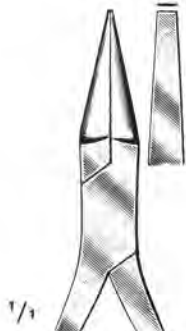

67.554.11



67.555.11



67.556.11



DUMONT  
11.5 cm



67.560.11



67.561.11

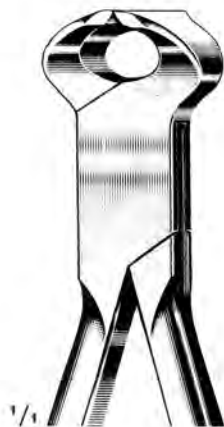

67.562.12  
12.5 cm



67.563.11  
11 cm



67.564.12  
12 cm



67.572.11  
11 cm

End Nippers Wire and Bar Bending Pliers  
 Alicates cortantes, Alicates para doblar alambres y barras  
 Zwickzange, Draht - und Bügelbiegezaugen



Diamond Jaws  
 67.574.14  
 16 cm



SCHWARZ  
 67.604.13  
 Model I  
 13 cm



SCHWARZ  
 67.606.13  
 Model II  
 13 cm



SCHWARZ  
 67.608.13  
 Model III  
 13 cm

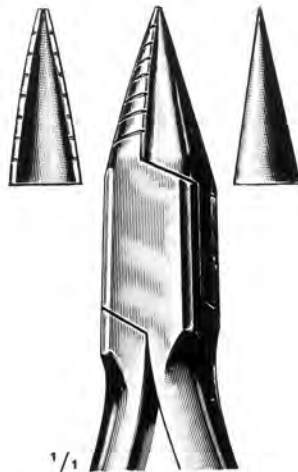

SCHWARZ  
 67.612.14  
 14.5 cm



FISCHER  
 67.616.14  
 14 cm



ANDRESEN  
 67.620.12  
 14 cm

Bar Clasp and wire Banding Pliers  
 Alicates para doblar barras, ganchos y alambres  
 Bügel -, Klammern - und drahtbiegezangen



**McKELLOPS**  
67.624.17  
17 cm



**McKELLOPS**  
67.626.16  
16 cm



**WALDRON**  
67.636.12  
12.5 cm

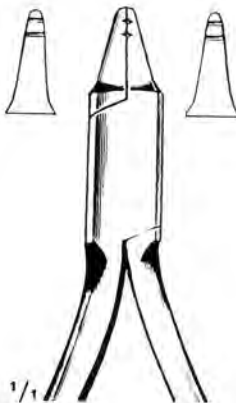

**OLIVER**  
67.640.12  
12.5 cm



**STADLER**  
67.632.15  
15 cm

Bending and Ligature Pliers  
 Alicates para ganchos y ligaduras  
 Klammernbiegeezangen und Ligaturenzange

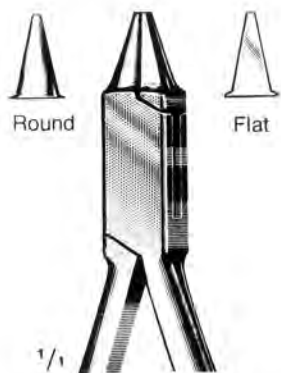

**ANGLE**  
 67.650.12  
 12 cm / 4¾"

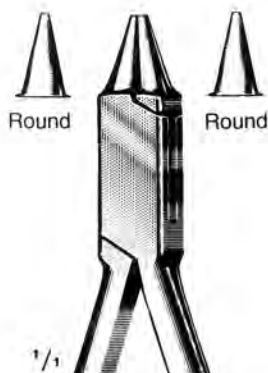

**ANGLE**  
 67.651.12  
 12 cm / 4¾"



**ADAMS**  
 67.654.13  
 13 cm / 5"

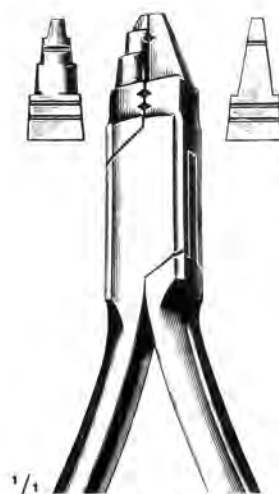

**YOUNG**  
 67.660.13  
 13 cm / 5"



**ADERER**  
 67.672.11  
 11.5 cm / 4½"



**ADERER**  
 67.674.13  
 13 cm / 5"



**ANGLE**  
 67.679.13  
 13 cm / 5"



**ADERER**  
 67.684.14  
 14 cm / 5½"

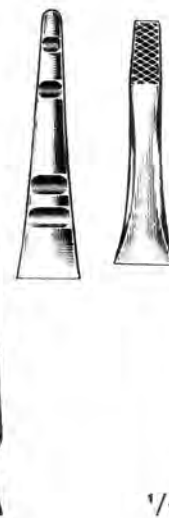

**FISCHER**  
 67.686.13  
 13 cm / 5¼"



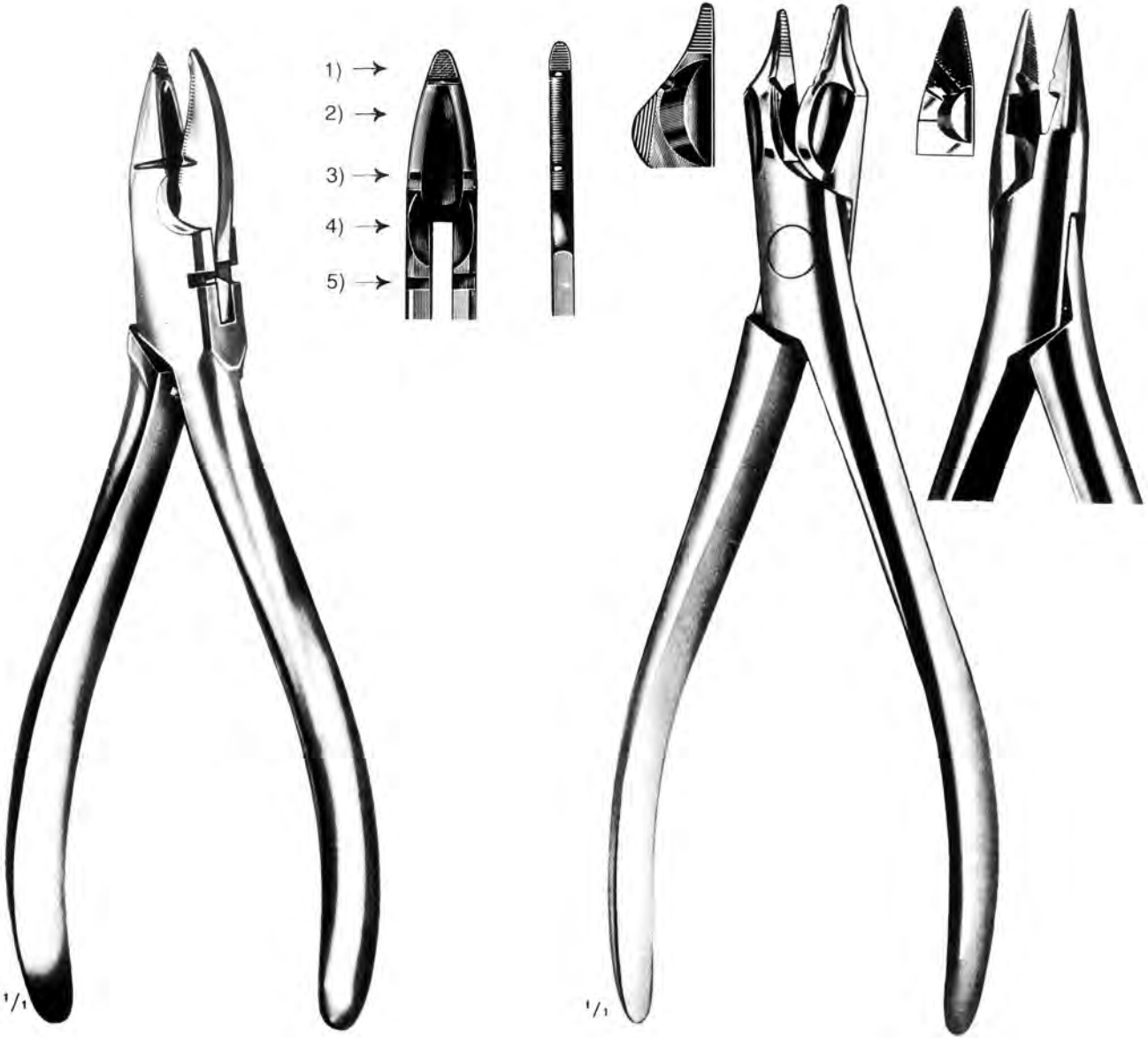

1/1  
**WALDSACHS-UNIVERSAL**  
67.690.15  
15.5 cm / 6"

1/1  
**UNIVERSAL**  
67.697.15  
15.5 cm / 6"

Copper Ring and Bridge Removing Pliers  
Alicates para quitar anillos de cobre y puentes  
Kupferring - und Brückenabnehmerzangen



FURRER  
67.702.15  
16 cm / 6¼"



FURRER  
67.703.15  
16 cm / 6¼"



FURRER  
67.705.15  
16 cm / 6¼"

Clasp Bending pliers - Collar Pliers  
 Alicates para doblar ganchos y para cuellos de coronas  
 Klammernbiegezangen, Kronenbänderzangen usw



**WEINGART**  
67.711.14  
14 cm

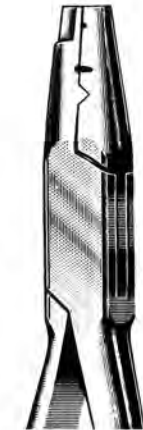

**SCHWARZ**  
67.720.12  
12.5 cm / 5"



**SCHWARZ**  
67.723.12  
12.5 cm / 5"



**ADERER**  
67.726.15  
15 cm / 6¼"

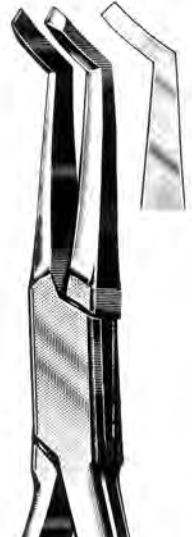

**KOERBITZ**  
67.733.14  
14 cm / 5½"

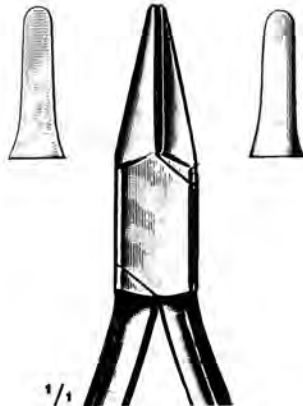

**ROBINSON**  
67.740.12  
12.5 cm / 5"

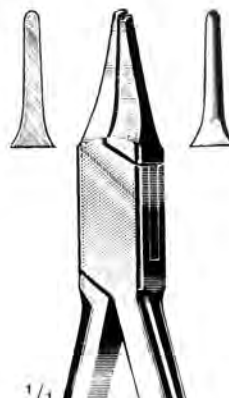

**PEESO**  
67.742.12  
12.5 cm / 5"



**PEESO**  
67.744.12  
12.5 cm / 5"

Crown Pliers  
 Alicates para coronas  
 Kronenzangen



TRYFUS  
 67.760.16  
 16.5 cm / 6½"

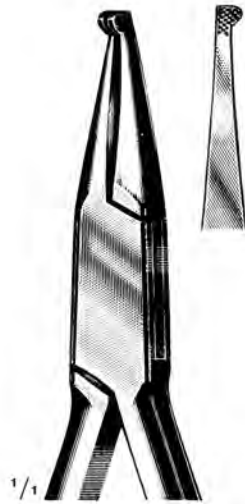

HOW  
 67.750.14  
 14 cm / 5½"

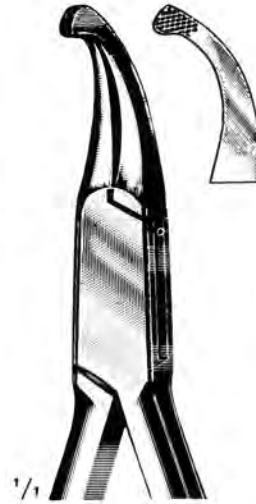

HOW  
 67.751.14  
 14 cm / 5½"



ZIEBE  
 67.766.13  
 13 cm / 5"



PEESO  
 67.770.14  
 14.5 cm / 5¾"

Crown stretching, contouring and Ligature Cutting Pliers  
 Alicates para ensanchar coronas, para contornen y alicates cotantes para ligaduras  
 Kronenstreakzange, konturzangen und ligaturen - schneidezange



**HERBST**  
67.774.14  
14 cm / 5½"



**FREVERT**  
67.776.12  
12 cm / 4¾"



**REYNOLDS**  
67.783.12  
12.5 cm / 5"



**GORDON**  
67.785.14  
14 cm / 5½"



**TRIPLEX**  
67.780.14  
14 cm / 5½"

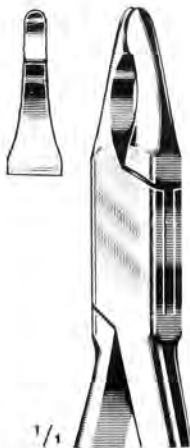

**JOHNSON**  
67.788.13  
13 cm / 5"

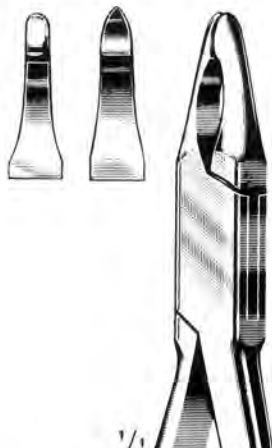

**JOHNSON**  
67.790.13  
13 cm / 5"

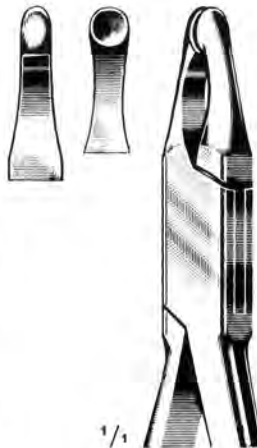

**ABELL**  
67.794.13  
13 cm / 5"

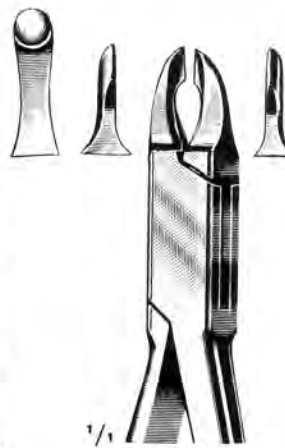

**ANGLE**  
67.796.13  
13 cm / 5"



# INDEX OF NUMBERS

## A

|                                  |         |
|----------------------------------|---------|
| ABBOT Scalers                    | 79      |
| ABEL Ligature Cutting Pliers     | 153     |
| ABRAHAM Cleft Palate Knife       | 28      |
| ADERER Bending & Ligature Pliers | 148     |
| ADERER Clasp Bending Pliers      | 151     |
| ADSON - BROWN Tissue Forceps     | 9       |
| ADSON Tissue Forceps             | 9       |
| AINSWORTH Rubber Dam Punch       | 130     |
| Amalgam Carrier                  | 113     |
| ANDERSON Bar Bending Pliers      | 146     |
| ANGLE Bending & Ligature Pliers  | 148     |
| ANGLE Ligature Cutting Pliers    | 153     |
| APEXO Root Elevators             | 63      |
| ARRINGTON Instruments            | 110     |
| ARRINGTON Nerve Instruments      | 105     |
| ARRUGA Needle Holder             | 18      |
| ARRUGA Needle Holder TC          | 14      |
| ASH Plastic Filling Instruments  | 119-120 |
| ARTHUR Splinter Forceps          | 10      |
| Awls                             | 19      |

## B

|                                     |         |
|-------------------------------------|---------|
| BAADE Crown & Band Remover          | 131     |
| BACK HAUS Towel Clamp               | 12      |
| BALDWIN Plastic Filling Instruments | 119     |
| Band Pusher                         | 13      |
| Remover                             | 13      |
| Setter                              | 13      |
| BARRAQUER Needle Holder             | 18      |
| BEALE Carvers                       | 138     |
| BEEBEE Scissors                     | 3       |
| BEIN Root Elevators                 | 60,67   |
| BENNET Plastic Filling Instruments  | 122     |
| BEYER Bone Rougeurs                 | 107     |
| BLACK Instruments                   | 110     |
| BLACK Cutting Instruments           | 102,104 |
| BLACK Finishing Instruments         | 109     |
| BLACK Scales                        | 81      |
| BLUMENTHAL Bone Rongeurs            | 106     |
| BOHM Crown Instruments              | 141     |
| Bone Rongeurs                       | 106-107 |
| BOYNTON Needle Holder               | 18      |
| BRADC Root Elevators                | 62      |
| BREWER Rubber Dam Punch             | 130     |
| BRIAULT Probes & Explorers          | 93      |
| BRUENINGS Tongue Depressor          | 26      |
| Burnishers                          | 114     |
| BRUNS Bone Curettes                 | 22      |
| BUCK Periodontia Instruments        | 82      |
| BUNTING Scalers                     | 80      |
| BUSCH Extracting Forceps            | 36      |
| BUXTON Mouth gag                    | 24      |

## C

|                                       |     |
|---------------------------------------|-----|
| Caliper Wax                           | 143 |
| CANFIELD Cleft Palate Knife           | 28  |
| CASTROVIEJO Needle Holder             | 18  |
| CASTROVIEJO-BARRAQUER Needle Holder   | 18  |
| CESPA Cement Spatula,                 | 128 |
| CHEATLE Sterilizing Forceps           | 108 |
| Chisels                               | 89  |
| Clamps Towel                          | 12  |
| CLEVELAND Bone Rongeurs               | 107 |
| CLEVELAND GARDENER Bone Rongeurs      | 107 |
| CLEVELAND Plastic Filling Instruments | 121 |
| CLEVELAND Scalers                     | 78  |

|                                      |       |
|--------------------------------------|-------|
| COGSWELL Root Elevator               | 63    |
| COHEN Extracting Forceps             | 42    |
| COLEMAN Root Elevator                | 68    |
| COLLIER Needle Holder                | 15    |
| COLLIN Tongue Depressor              | 26    |
| COLLIN Tongue Holding Forceps        | 28    |
| COUPLAND Root Elevator               | 65-66 |
| CRANE Root Elevator                  | 66    |
| CRANE-KAPLAN Periodontia Instruments | 87    |
| CRILE Artery Forceps                 | 12    |
| CRILE Needle Holder                  | 17    |
| CRILE-MURRAY Needle Holder           | 16    |
| CRILEWOOD Needle Holder              | 16    |
| CRILEWOOD Needle Holder TC.          | 14    |
| Crown Band Remover                   | 131   |
| Setter                               | 131   |
| CRYER Extracting Forceps             | 55    |
| CRYER Root Elevator                  | 64,67 |
| CUMINE Scalers                       | 79    |
| Curettes Bone                        | 22-23 |
| CURTIN Root Elevator                 | 62    |

## D

|                             |       |
|-----------------------------|-------|
| DARBY-PERRY Scalers         | 78    |
| DAVIS Sterilizing Forceps   | 108   |
| DAY Cleft Palate Knife      | 28    |
| DEANS Scissors              | 5     |
| Deaver Scissors             | 1     |
| DENHART Mouth Gag           | 24    |
| Dental Extracting Forceps   |       |
| English Pattern             | 29-46 |
| American Pattern            | 47-58 |
| DERF Needle Holder          | 15    |
| DERF Needle Holder TC       | 14    |
| DIDNER Matrix Retainer      | 129   |
| DIFFENBACH Artery Forceps   | 11    |
| DOYEN Mouth Gag             | 24    |
| DOYEN Tongue Depressor      | 26    |
| DUMONT End & Side Nipler    | 145   |
| DUMONT Flat Nose Pliers     | 145   |
| DURHAM Cleft Palate Needles | 28    |

## E

|                                     |        |
|-------------------------------------|--------|
| EDWARDS Plastic Filling Instruments | 119    |
| Elevators Root                      | 59-71  |
| Enamel Cleavers                     | 89     |
| ENGLISH Model Towel Clamps          | 12     |
| ERMERT Carvers                      | 138    |
| EVANS Carvers                       | 137    |
| Explorers                           | 90-95  |
| Excavators                          | 95-101 |

## F

|                                   |           |
|-----------------------------------|-----------|
| FAHNENSTOCK Wax Knives            | 139       |
| FEILCHENFELD Splinter Forceps     | 10        |
| FERGUSON Mouth Gags               | 24        |
| FERRIS SMITH Needle Holder        | 16        |
| Finger Protector                  | 25        |
| FISCHER Bar Bending Pliers        | 146       |
| FISCHER Bending & Ligature Pliers | 148       |
| FJELDSTAD Carvers                 | 136       |
| FLAGG Dressing Tweezers           | 75        |
| FLESCH Extracting Forceps         | 54        |
| FLOHR Root Elevators              | 60-68, 71 |
| Forceps Artery                    | 11-12     |
| Dental Extracting                 | 29-58     |
| Dressing                          | 8-9       |

|   |       |
|---|-------|
| Dressing & Cotton Swab Holding              | 13    |
| Fine Tissue                                 | 76    |
| Gum Guillotine                              | 7     |
| Micro                                       | 9     |
| Splinter                                    | 10    |
| Sterilizing                                 | 108   |
| Tissue                                      | 8-9   |
| Tongue Holding                              | 28    |
| FOSTER-FLAGG Instruments                    | 110   |
| FRAHM Carvers                               | 137   |
| FRENZEL Tongue Depressor                    | 26    |
| FREVERT Crown Stretching Pliers             | 153   |
| FRIEDMAN Bone Rongeurs                      | 106   |
| FRIEDMAN Excavators                         | 99    |
| FRIEDMAN Root Elevator                      | 66,71 |
| FURRER Copper Ring & Bridge Removing Pliers | 150   |

## G

|                                    |     |
|------------------------------------|-----|
| GILLIES Needle Holder              | 17  |
| GILLET Excavators                  | 97  |
| GLOBE Scalers                      | 81  |
| GOLDMAN Fox Gum Guillotine Forceps | 7   |
| GOLDMAN Fox Scissors               | 2   |
| GORDON Contouring Pliers           | 153 |
| GOSLEE Flat Nose Pliers            | 143 |
| GLOSS-MAIER Dressing Forceps       | 13  |
| GUENTHER Scalers                   | 79  |
| GUY Extracting Forceps             | 40  |

## H

|                                       |       |
|---------------------------------------|-------|
| HALSEY Needle Holder                  | 15    |
| HALSTEAD Mosquito Artery Forceps      | 11    |
| HARRIS Extracting Forceps             | 49    |
| HARTMANN Artery Forceps               | 11    |
| HAUBEIL Instruments                   | 111   |
| HEIDBRINK Root Elevators              | 63    |
| HEIDEMANN Plastic Filling Instruments | 119   |
| HEISTER Mouth Gag                     | 24    |
| HEGAR-BAUMGARTNER Needle Holder       | 14-15 |
| HENAKAK Extracting Forceps            | 48    |
| HERBST Crown Stretching Pliers        | 153   |
| HOLLENBACK Instruments                | 112   |
| HOSPITAL Enamel Cleavers              | 89    |
| HOW Crown Pliers                      | 152   |
| HULL Extracting Forceps               | 53    |
| HUNT Gutta Percha Spatula             | 126   |
| HUNTER Splinter Forceps               | 10    |
| HYLIN Root Elevator                   | 68    |
| HYLIN Wax & Modelling Carvers         | 135   |

## I

|                             |         |
|-----------------------------|---------|
| Instruments Amalgam, Cement | 110,113 |
| Axial Filling               | 123,125 |
| Crown                       | 140-142 |
| Cutting                     | 102-104 |
| Finishing                   | 109     |
| Lifting & Loosening         | 114     |
| Plastic Filling             | 115-122 |
| Nerve                       | 105     |
| IVORY Amalgam Carrier       | 113     |
| IVORY Gutta-Percha Spatula  | 126     |
| IVORY Matrix Retainers      | 129     |
| IVORY Rubber Dam Punch      | 130-131 |
| IVORY Separators            | 128     |



**J**

|                                  |     |
|----------------------------------|-----|
| JAQUETTE Scalers                 | 78  |
| JAQUETTE Periodontia Instruments | 82  |
| JOHNSON Ligature Cutting Pliers  | 153 |
| JONES Towel Clamps               | 12  |
| JOSEPH Scissors                  | 2   |

**K**

|                                       |     |
|---------------------------------------|-----|
| KELLS Extracting Forceps              | 53  |
| KELLY Artery Forceps                  | 11  |
| KELLY Scissors                        | 4   |
| KIRKLAND Periodontia Instruments      | 87  |
| KLEIN Extracting Forceps              | 46  |
| Knives Cleft Palate                   | 28  |
| KOCHER Artery Forceps                 | 12  |
| KOERBITZ Clasp Bending Pliers         | 151 |
| KRENN Lifting & Loosening Instruments | 114 |

**L**

|                                       |         |
|---------------------------------------|---------|
| LADMORE Plastic Filling Instruments   | 116     |
| LA-GRANGE Scissors                    | 4       |
| LANGE Probes & Explorers              | 94      |
| LANGENBECK Finger Protector           | 25      |
| LANGENBECK Pliers                     | 143-144 |
| LAWRENCE-READ Extracting Forceps      | 38,45   |
| LECLUSE Root Elevators                | 70      |
| LECRON Wax & Modelling Carvers        | 135     |
| LE MEE Tongue Depressor               | 27      |
| LESSMANN Modelling Spoon              | 132     |
| LEWIS Amalgam & Cement Instruments    | 110     |
| LINESMANN Plastic Filling Instruments | 122     |
| LISTER Bandage Scissors               | 20      |
| LITTATUER Stitch Scissors             | 3       |
| LOCKLIN Scissors                      | 4       |
| LONDON-COLLEGE Dressing Tweezers      | 74      |
| LONDON-HOSPITAL Root Elevator         | 68      |
| LOOS Root Elevator                    | 70      |
| LORNA Towel Clamps                    | 12      |

**M**

|  |     |
|--|-----|
| MACMILLAN Root Elevator                        | 66  |
| MALL Amalgam Gutta-Percha & Cement Instruments | 11  |
| Mallets  | 21  |
| MALL-RONDOFLEX Cement Spatula                  | 127 |
| MARTINI Bone Curettes                          | 23  |
| MATHIEU Needle Holder                          | 17  |
| MATHIEU Needle Holder TC                       | 14  |
| Matrix Pliers                                  | 130 |
| Matrix Retainers                               | 129 |
| MAYO HEGAR Needle Holder                       | 16  |
| MAYO HEGAR Needle Holder TC                    | 14  |
| MAYO Scissors                                  | 2   |
| MAYO Tongue Depressor                          | 26  |
| McCALL Scalers                                 | 80  |
| McKELLOPS Bar Clasp Pliers                     | 147 |
| MEAD Bone Rongeurs                             | 106 |
| MEAD Extracting Forceps                        | 41  |
| MEAD Mallet                                    | 21  |
| MERCITAN Periodontia Instruments               | 80  |
| MERIAM Dressing Forceps                        | 75  |
| MERSHAM Band Pusher                            | 131 |
| MESSER Plastic Filling Instruments             | 119 |
| METZENBAUM Scissors                            | 2   |
| MICRO-MOSQUITO Artery Forceps                  | 11  |
| MILLER Crown Remover                           | 140 |
| MILLER-APEXO Root Elevators                    | 61  |
| MILWAUKEE Extracting Forceps                   | 48  |

|  |         |
|--|---------|
| MINI-FRIEDMANN Bone Rongeurs               | 106     |
| Mirror Mouth                               | 73      |
| Handle                                     | 73      |
| MITCHELL Scalers                           | 79      |
| MITCHELL Enamel Cleavers                   | 89      |
| MODELL-AMALG Instruments                   | 111     |
| MOD MARTIN Lifting & Loosening Instruments | 114     |
| MOD PLASTIC Filling Instruments            | 117-118 |
| MOD-SPATULA Plastic Filling Instruments    | 115-116 |
| MODE USA Instruments                       | 112     |
| MOLT Mouth Gags                            | 24      |
| MONFORT Crown Slitter                      | 142     |
| MOORE Scalers                              | 78      |
| MOUTH Gags                                 | 24-25   |
| MUEHLEMANN Scalers                         | 81      |

**N**

|                           |       |
|---------------------------|-------|
| Needle Holders            | 14-18 |
| Needle Cleft Palate       | 28    |
| Sutures                   | 19    |
| NEIVERT Needle Holder     | 15    |
| NEUMANN Scissors          | 4     |
| NEVIUS Extracting Forceps | 53,54 |
| NIPPERS Endside           | 145   |
| NORMAL Extracting Forceps | 48    |
| NORTHBENT Scissors        | 3     |
| NOYES Scissors            | 6     |

**O**

|                                 |       |
|---------------------------------|-------|
| OGDEN-FELSCH Extracting Forceps | 39    |
| OLIVER Wire Bending Pliers      | 147   |
| OLSEN-HEGAR Needle Holders      | 16-17 |
| OLSEN-HEGAR Needle Holder TC    | 14    |
| OPPIE McCALL Scalers            | 78    |

**P**

|                               |         |
|-------------------------------|---------|
| PALM Rubber Dam Punch         | 130     |
| PARMLY Extracting Forceps     | 51      |
| PARTSCH Mallet                | 21      |
| PASSO Extracting Forceps      | 39      |
| PEAN Artery Forceps           | 12      |
| PESSO Collar Pliers           | 151     |
| PESSO Crown Pliers            | 152     |
| PEET Splinter Forceps         | 10      |
| Periodontia Instruments       | 82-88   |
| PHYSICK Extracting Forceps    | 49      |
| PICHLER Finishing Instruments | 109     |
| PLASTER Nipper                | 134     |
| Pliers                        | 143-153 |
| Probes                        | 90-95   |
| POTT Root Elevator            | 70      |
| POTTS-SMITH Dressing Forceps  | 9       |
| POTTS-SMITH Tissue Forceps    | 9       |

**Q**

|                 |   |
|-----------------|---|
| QUINBY Scissors | 4 |
|-----------------|---|

**R**

|                            |     |
|----------------------------|-----|
| RALK Splinter Forceps      | 10  |
| Retractors Cheek           | 27  |
| Lip                        | 27  |
| REVERDIN Needles           | 19  |
| REYNOLDS Contouring Pliers | 153 |
| RIEGNER Carvers            | 137 |
| ROACH Carvers              | 136 |

|                           |         |
|---------------------------|---------|
| ROBINSON Collar Pliers    | 151     |
| ROGGE Sterilizing Forceps | 108     |
| ROOT Elevators            | 59-71   |
| ROSER-KONIG Mouth Gag     | 24      |
| Rubber Dam Clamps         | 132-133 |
| Rubber Dam Punches        | 130-131 |

**S**

|                                    |         |
|------------------------------------|---------|
| SANDERS Periodontia Instruments    | 82      |
| Scalers                            | 77-81   |
| SCHAEDLE Towel Clamps              | 12      |
| SCHARMANN Scalers                  | 80      |
| SCHEDE Bone Curettes               | 22      |
| SCHMECKEBIER APEXO Root Elevators  | 60      |
| SCHWARZ Bending Pliers Bar         | 146     |
| SCHWARZ Clasp Bending Pliers       | 151     |
| SCHWEIZER MODEL Probes & Explorers | 92      |
| Scissors Bandage                   | 20      |
| Gum                                | 4-6     |
| Ligature                           | 3       |
| Micro                              | 6       |
| Operating                          | 1-3     |
| SELDIN Root Elevators              | 61-62   |
| Separators & Matrix Retainers      | 129     |
| SIMPLEX Check Retractor            | 27      |
| SHORTBENT Scissors                 | 3       |
| SMITH Bandage Scissors             | 20      |
| SMITH Plastic Filling Instruments  | 119     |
| SPATULA Gutta-Percha & Cement      | 126-128 |
| Silicate                           | 128     |
| Wax                                | 138     |
| SPENCER Scissors                   | 3       |
| SPOON Modelling                    | 139     |
| SPRATT Bone Curettes               | 22      |
| STADLER Wire Bending Pliers        | 147     |
| Standard Extracting Forceps        | 48      |
| STERNBERG Check Retractor          | 27      |
| STIEGLITZ Splinter Forceps         | 10      |
| STIKSA Extracting Forceps          | 42      |
| STOCKES Rubber Dam Punch           | 130     |
| STOUT Root Elevators               | 62-63   |
| SWING Extracting Forceps           | 57      |
| Syringes Amalga                    | 113     |
| Injection                          | 72      |
| Water                              | 72      |

**T**

|                                 |       |
|---------------------------------|-------|
| THOMAS Extracting Forceps       | 52    |
| THUERRIEGEL Cutting Instruments | 105   |
| TOFFLEMIRE Matrix Retainer      | 129   |
| TOMATI Gum Guillotine Forceps   | 7     |
| TOMES Extracting Forceps        | 52    |
| TOMPKINS Scalers                | 81    |
| TOMPKINS Finishing Instruments  | 109   |
| Tongue Depressors               | 26-27 |
| TRIPLEX Pliers                  | 153   |
| TROTTER Extracting Forceps      | 40    |
| TRYFUS Crown Pliers             | 152   |
| TUTTLE Matrix Pliers            | 130   |
| Tweezers Cotton & Dressing      | 74-75 |

**U**

|                                       |     |
|---------------------------------------|-----|
| UNIVERSAL Bandage Scissors            | 20  |
| UNIVERSAL Scissors                    | 3   |
| UNIVERSAL Pliers                      | 149 |
| UNIVERSAL Sterilizing Forceps         | 108 |
| UNIVERSITY OF MICHIGAN Root Elevators | 66  |
| UNIVERSITY OF MINNESOTA Lip Retractor | 27  |
| USA MODEL Bone Curette                | 23  |
| USA MODEL Thumb Forceps               | 8   |



## V

|                                   |     |
|-----------------------------------|-----|
| VAJNA Plastic Filling Instruments | 122 |
| VEHE Carvers                      | 136 |
| VOLKMANN Bone Curettes            | 22  |

## W

|                                      |         |
|--------------------------------------|---------|
| WAGNER Gum Scissors                  | 5       |
| WALDSACHS Universal Pliers           | 149     |
| WALDRON Wire Bending Pliers          | 147     |
| WALTER F. BARRY Root Elevator        | 69      |
| WALTER Splinter Forceps              | 10      |
| WARDKIRKLAND Periodontia Instruments | 86      |
| WARWICK JONES Root Elevator          | 71      |
| Wax Knives                           | 139     |
| Wax Porcelain & Modelling Carvers    | 135-139 |
| Wax Spatula                          | 139     |
| WEBSTER Needle Holder                | 15      |
| WEDELSTAEDT Enamel Cleavers          | 89      |
| WEDELSTAEDT Finishing Instruments    | 109     |
| WEINGART Clasp Bending Pliers        | 151     |
| WESCOTT Scissors                     | 6       |
| WESTON Cement Spatula                | 128     |
| WESTON Instruments                   | 110     |
| WESTON Probes & Explorers            | 94      |
| WHITE Burnishers                     | 114     |
| WHITE Chisels                        | 89      |
| WHITE Enamel Cleavers                | 89      |
| WHITE Excavators                     | 100     |
| WHITE Plastic Filling Instruments    | 120-121 |
| WHITE Probes & Explorers             | 90      |
| WHITE Scalers                        | 78      |
| WHITE HEAD Mouth Gag                 | 25      |
| WHITESIDE Scalers                    | 80      |
| WHITTEN Scalers                      | 78      |
| WIEDER Tongue Depressor              | 27      |
| WILLIAMS Plastic Filling Instruments | 121     |
| WILLIGER Bone Curettes               | 23      |
| WILLIGER Mallet                      | 21      |
| WINTER Root Elevators                | 69      |
| WISDOM-ROUTURIER Extracting Forceps  | 43      |
| WITZEL Cutting Instruments           | 105     |
| WITZEL Extracting Forceps            | 36,58   |
| WITZEL Probes & Explorers            | 95      |
| WOLFF Carvers                        | 136     |
| WOODSON Instruments                  | 110     |
| WOODSON Plastic Filling Instruments  | 121     |
| WOODWARD Extracting Forceps          | 48      |
| WOODWARD Root Elevators              | 65      |

## Y

|                                 |     |
|---------------------------------|-----|
| YOUNG Bending & Ligature Pliers | 148 |
| YOUNG Tongue Holding Forceps    | 28  |
| YOUNGER GOOD Scalers            | 80  |

## Z

|                    |     |
|--------------------|-----|
| ZAHLE Carvers      | 135 |
| FERFING Scalers    | 78  |
| ZIEBE Crown Pliers | 152 |

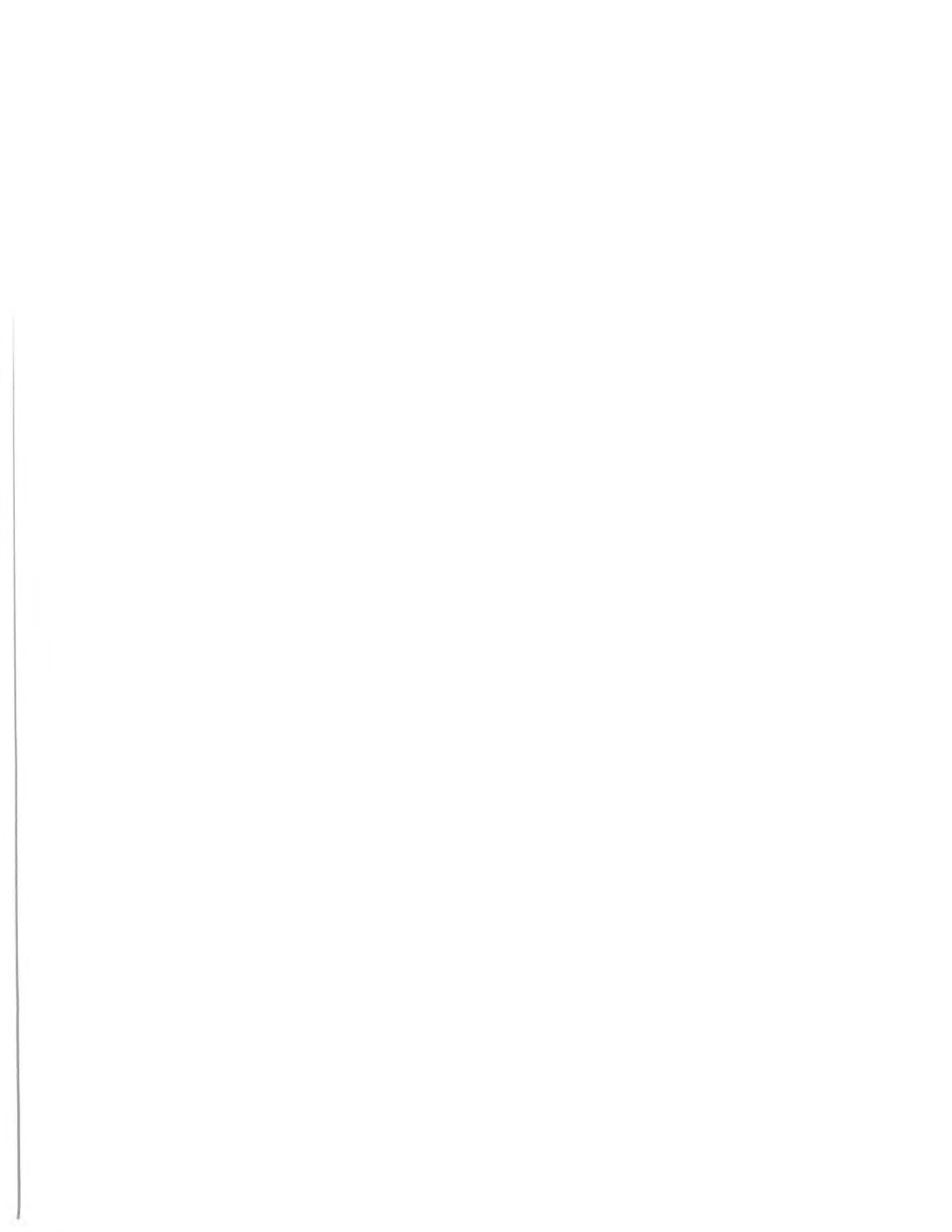

# NUMMERN VERZEICHNIS

## A

|   |         |
|---|---------|
| ABBOT Reinigungsinstrument                                | 79      |
| ABEL Konturzanger   | 153     |
| ABRAHAM Gaumenmesser                                      | 28      |
| ADERER Klammern biegezege und ligature                    | 148     |
| ADERER Klammern biegezege                                 | 151     |
| ADSON - BROWN Chirurgische Pinzetten                      | 9       |
| ADSON Chirurgische Pinzetten                              | 9       |
| AINSWORTH Küfferdam Lechzangen                            | 130     |
| ANDERSON Bugelluegezege                                   | 146     |
| ANGLE Klammernligazege und ligature zange                 | 148     |
| ANGLE Ligaturen schneidezege                              | 153     |
| APEXO Wurzelheber   | 63      |
| ARRINGTON Instrumente für Amalgam Gutta Percha und zement | 110     |
| ARRINGTON Nerv Instrumente                                | 105     |
| ARRUGA Nadelhalter  | 18      |
| ARRUGA Nadelhalter TC                                     | 14      |
| ASH Instrumente für plastische Füllungen                  | 119-120 |
| ARTHUR Splitterzangen                                     | 10      |

## B

|   |         |
|---|---------|
| BAADE Kroneninstrumente                                 | 131     |
| BACKHAUS Tuchklemmen                                    | 12      |
| BALDWIN Instrumente für plastische Füllungen            | 119     |
| BARRAQUER Nadelhalter                                   | 18      |
| BEALE Modellurinstrumente                               | 138     |
| BEEBEE Ligaturschenen                                   | 3       |
| BEIN Wurzelheber  | 60,67   |
| BENNET Instrumente für plastische Füllungen             | 122     |
| BEYER Hahlmeisszangen                                   | 107     |
| BLACK Instrumente für Amalgam, Gutta, percha und zement | 110     |
| BLACK schneideude Instrumente                           | 102,104 |
| BLACK Finierinstrumente                                 | 109     |
| BLACK Modellur instrumente                              | 81      |
| BLUMENTHAL Hahlmeisszangen                              | 106     |
| BOHM Kronen Instrumente                                 | 141     |
| BOYNTON Nadelhalter                                     | 18      |
| BRADC Wurzh heben                                       | 62      |
| BREWER Küfferdam Lochzangen                             | 130     |
| BRIAULT Zahnsanden                                      | 93      |
| BRUENINGS Zungensucker                                  | 26      |
| BRUNS Curetas Löffel                                    | 22      |
| BUCK Instrumente zur Parodontologie                     | 82      |
| BUNTING Reinigungsinstrumente                           | 80      |
| BUSCH Zahnzangen  | 36      |
| BUXTON Mundsperrern                                     | 24      |

## C

|  |     |
|--|-----|
| CANFIELD Gaumenmesser                          | 28  |
| CASTROVIEJO Nadelhalter                        | 18  |
| CASTROVIEJO-BARRAQUER Nadelhalter              | 18  |
| CESPA Zemenspatel                              | 128 |
| CHEATLE sterilisierzangen                      | 108 |
| CLEVELAND Hechl meisszangen                    | 107 |
| CLEVELAND GARDENER Hehlmeisszangen             | 107 |
| CLEVELAND Instrumente für plastische Füllungen | 121 |
| CLEVELAND Reinigungsinstrumente                | 78  |
| COGSWELL Wurzelheber                           | 63  |
| COHEN Zahnzangen                               | 42  |
| COLEMAN Wurzelheber                            | 68  |
| COLLIER Nadelhalter                            | 15  |
| COLLIN Zungendrucker                           | 26  |

|  |       |
|--|-------|
| COLLIN Zungenzangen                        | 28    |
| COUPLAND Wurzelheber                       | 65-66 |
| CRANE Wurzelheber                          | 66    |
| CRANE-KAPLAN Instrumente zur Pardontologie | 87    |
| CRILE Arterienklemmen                      | 12    |
| CRILE Nadelhalter                          | 17    |
| CRILE-MURRAY Nadelhalter                   | 16    |
| CRILEWOOD Nadelhalter                      | 16    |
| CRILEWOOD Nadelhalter TC.                  | 14    |
| CRYER Zahnzangen                           | 55    |
| CRYER Wurzelheber                          | 64,67 |
| CUMINE Reinigungsinstrumente               | 79    |
| CURTIN Wurzelheber                         | 62    |

## D

|                                   |     |
|-----------------------------------|-----|
| DARBY-PERRY Reinigungsinstrumente | 78  |
| DAVIS stilisierzangen             | 108 |
| DAY Gaumennadeln                  |     |
| DEANS Zahnfleischscheren          | 5   |
| DEAVER Chusurgische scheren       | 1   |
| DENHART Mundsferrer               | 24  |
| DERF Nadelhalter                  | 15  |
| DERF Nadelhalter TC               | 14  |
| DIDNER Matrixzenspannen           | 129 |
| DIFFENBACH Arterienklemmen        | 11  |
| DOYEN Mundsperrern                | 24  |
| DOYEN zumgedrucken                | 26  |
| DUMONT Zwickzangen                | 145 |
| DUMONT Flachzangen                | 145 |
| DURHAM Nadeln                     | 28  |

## E

|  |     |
|--|-----|
| EDWARDS Instrumente für plastische Füllungen | 119 |
| ENGLISH Model Tuchklemmen                    | 12  |
| ERMERT Modellurinstrumente                   | 138 |
| EVANS Modellierinstrumente                   | 137 |

## F

|  |           |
|--|-----------|
| FAHNENSTOCK Wachmessen                                       | 139       |
| FEILCHENFELD splitterzangen                                  | 10        |
| FERGUSSON Mundoferrer  | 24        |
| FERRIS SMITH Nadelhalter                                     | 16        |
| FISCHER Birgelbiegezege                                      | 146       |
| FISCHER Ligaturenzege  | 148       |
| FJELDSTAD Modeller instrumente                               | 136       |
| FLAGG Zahnpunizetten   | 75        |
| FLESCH Zahnzangen  | 54        |
| FLOHR Wurzelheber  | 60-68, 71 |
| FOSTER-FLAGG Instrumente für Amalgam Gutta percha und zament | 110       |
| FRAHM Modellierinstrumente                                   | 137       |
| FRENZEL Zungendrucker  | 26        |
| FREVERT Kronunsteakzange                                     | 153       |
| FRIEDMAN Exkavatoren   | 99        |
| FRIEDMAN Root Elevator                                       | 66,71     |
| FRIEDMAN Hahlmeisszangen                                     | 106       |
| FURRER Kupferring-und Bruckenabnehmzege                      | 150       |

## G

|                            |    |
|----------------------------|----|
| GILLIES Nadelhalter        | 17 |
| GILLET Excavatoren         | 97 |
| GLOBE Reingungsinstrumente | 81 |

|  |     |
|--|-----|
| GOLDMAN FOX Knochen-und weichgewebekneifer | 7   |
| GOLDMAN FOX Scharen                        | 2   |
| GORDON Konturzangen                        | 153 |
| GOSLEE Flachzangen                         | 143 |
| GROSS-MAIER Kom-und-Tupferzangen           | 13  |
| GUENTHER Reinigungsinstrumente             | 79  |
| GUY Zahnzagen                              | 40  |

## H

|   |       |
|---|-------|
| HALSEY Nadelhalter                                      | 15    |
| HALSTEAD Arterienklemmen                                | 11    |
| HARRIS Zahnzangen                                       | 49    |
| HARTMANN Arterienklemmen                                | 11    |
| HAUBEIL Instrumente für Amalgam Gutta percha und zement | 111   |
| HEIDBRINK Wurzelheber                                   | 63    |
| HEIDEMANN Instrumente für plastische Füllungen          | 119   |
| HEISTER Mundsperser                                     | 24    |
| HEGAR-BAUMGARTNER Nadelhalter                           | 14-15 |
| HENAKAK Zahnzangen                                      | 48    |
| HERBST Kronenshiakzange                                 | 153   |
| HOLLENBACK Instrumente                                  | 112   |
| HOSPITAL Schmelz instrumente                            | 89    |
| HOW Kronenzangen  | 152   |
| HULL Zahnzangen   | 53    |
| HUNT Espalutas para Gutta percha                        | 126   |
| HUNTER Splitterzangen                                   | 10    |
| HYLIN Wurzelheber                                       | 68    |
| HYLIN Wachs und Modellier instrumente                   | 135   |

## I

|                                  |         |
|----------------------------------|---------|
| Instrumente Amalgam und Zement   | 110,113 |
| Kofferdam                        | 130-133 |
| Kronen                           | 140-142 |
| Nerv                             | 105     |
| Parodontologie                   | 80-88   |
| Plastische Füllung               | 115-122 |
| Reinigungsinstrumente            | 77-81   |
| Wachs, Porzellan - und Modellier | 135-138 |
| IVORY Amalgam Instrumente        | 113     |
| IVORY Espatula Guatta-percha     | 126     |
| IVORY Matrixzenspaner            | 129     |
| IVORY Kefferdam-Instrumente      | 130-131 |
| IVORY Kofferdam Lochzangen       | 129     |

## J

|                                     |     |
|-------------------------------------|-----|
| JAQUETTE Reinigungsinstrumente      | 78  |
| JAQUETTE Instrumente Parodontologie | 82  |
| JOHNSON Ligaturen schnerdezege      | 153 |
| JONES Tuch Klemmen                  | 12  |
| JOSEPH Chirurgische scheren         | 2   |

## K

|                                     |     |
|-------------------------------------|-----|
| KELLS Zahnzangen                    | 53  |
| KELLY Arterienklemmen               | 11  |
| KELLY Zahnfleischscheren            | 4   |
| KIRKLAND Instrumente Parodontologie | 87  |
| KLEIN Zahnzangen                    | 46  |
| KOCHER Arterienklemmen              | 12  |
| KOERBITZ Klammernbiegezege          | 151 |
| KRENN Plomben und Verschlussber     | 114 |

**L**

LADMORE Instrumente für plastische Füllungen 116

LA-GRANGE Zahnfleischscheren 4

LANGE Zahnsonden 94

LANGENBECK Fingerschützer 25

LANGENBECK Zangen 143-144

LAWRENCE-READ Zahnzangen 38,45

LECLUSE Wurzelheber 70

LECRON Wachs und Modellierinstrumente 135

LE MEE Zungendrucker 27

LESSMANN Wachsfilleser 139

LEWIS Amalgaminstrumente 110

LINESMANN Instrumente für plastische Füllungen 122

LISTER Verbandschere 20

LITTATUER Ligaturschere 3

LOCKLIN Zahnfleischschere 4

LONDON-COLLEGE Zahnpinzetten 74

LONDON-HOSPITAL Wurzelheber 68

LOOS Root Wurzelheber 70

LORNA Tuchklemmen 12

**M**

MACMILLAN Wurzelheber 66

MALL Instrumente Amalgam, Gutta-percha und zement 11

MALL-RONDOFLEX Zementspatel 127

MARTINI Scharfe Löffel 23

MATHIEU Nadelhalter 17

MATHIEU Nadelhalter TC 14

MAYO HEGAR Nadelhalter 16

MAYO HEGAR Nadelhalter TC 14

MAYO Chirurgische Scheren 2

MAYO Zungensücker 26

McCALL Reinigungsinstrumente 80

McKELLOPS Bügeilbiegezangen 147

MEAD Bone Hohlmeißelzangen 106

MEAD Zahnzangen 41

MEAD Hammer 21

MERCITAN Instrumente Parodontologie 80

MERIAM Zahnpinzetten 75

MERSHAM Kroneninstrumente 131

MESSER Instrumente für plastische Füllungen 119

Messwerkzeuge 142

METZENBAUM Chirurgische Scheren 2

MICRO-MOSQUITO Arterienklemmen 11

MILLER Kroneninstrumente 140

MILLER-APEXO Wurzelheber 61

MILWAUKEE Zahnzangen 48

MINI-FRIEDMANN Hohlmeißelzangen 106

Mundspiegel 73

Abhalterspiegel 73

MITCHELL Reinigungsinstrumente 79

MITCHELL Schmelzinstrumente 89

MODELL-AMALG Instrumente 111

MOD MARTIN Plomben und Verschlussheber 114

MOD PLASTIC Instrumente für plastische Füllungen 117-118

MOD-SPATULA Instrumente für plastische Füllungen 115-116

MODE USA Instrumente 112

MOLT Mundsperrer 24

MONFORT Kronenauf Schneidezange 142

MOORE Reinigungsinstrumente 78

MUEHLEMANN Reinigungsinstrumente 81

**N**

NEIVERT Nadelhalter 15

NEUMANN Zahnfleischscheren 4

NEVIUS Zahnzangen 53,54

NOYES Mikro-Schere 6

NORMAL Zahnzangen 48

NORTHBENT Ligaturschere 3

**O**

OGDEN-FELSCH Zahnzangen 39

OLLIVER Drahtbiegezangen 147

OLSEN-HEGAR Nadelhalter 16-17

OLSEN-HEGAR Nadelhalter TC 14

OPPIE McCALL Reinigungsinstrumente 78

**P**

PALMER Kofferdam-Lochzangen 130

PARMLY Zahnzangen 51

PARTSCH Hämmer 21

PASSO Zangzangen 39

PEAN Arterienklemmen 12

PESSO Kronenbanderzangen 151

PESSO Kronenzangen 152

PEET Splitterzangen 10

PHYSICK Zahnzangen 49

PICHLER Finierinstrumente 109

POTT Wurzelheber 70

POTTS-SMITH Anatomische Pinzetten 9

POTTS-SMITH Chirurgische Pinzetten 9

**Q**

QUINBY Zahnfleischschere 4

**R**

RALK Splitterzangen 10

REVERDIN Nadel 19

REYNOLDS Konturzangen 153

RIEGNER Modellierinstrumente 137

ROACH Modellierinstrumente 136

ROBINSON Kronenbanderzangen 151

ROGGE Sterilisierzangen 108

ROSER-KONIG Mundsperrier 24

**S**

SANDERS Instrumente Parodontologie 82

SCHAEDLE Tuchklemmen 12

SCHARMANN Reinigungsinstrumente 80

SCHEDE Scharfe Löffel 22

SCHMECKEBER APEXO Wurzelheber 6

SCHWARZ Bugeilbiegezangen 146

SCHWARZ Klammernbiegezangen 151

SCHWEIZER MODEL Zahnsonden 92

SELDIN Wurzelheber 61-62

SIMPLEX Wangenhalter 27

SHORTBENT Ligaturschere 3

SMITH Verbandschere 20

SMITH Instrumente für plastische Füllungen 119

SPENCER Ligaturschere 3

SPRATT Scharfe Löffel 22

Spritz Amalgam 113

injektion 72

wasser 22

STADLER Drahtbiegezangen 147

Standard Zahnzangen 48

STERNBERG Wagenhalter 27

STIEGLITZ Splitterzangen 10

STIKSA Zahnzangen 42

STOCKES Kofferdam-Lochzangen 130

STOUT Wurzelheber 62-63

SWING Zahnzangen 57

**T**

THOMAS Zahnzangen 52

THUERRIEGEL Schneidende Instrumente 105

TOFFLEMIRE Matrixzenspanner 129

TOMATI Zahnfleischklappenstanzen 7

TOMES Zahnzangen 52

TOMPKINS Reinigungsinstrumente 81

TOMPKINS Finierinstrumente 109

TRIPLEX Zangen 153

TROTTER Zahnzangen 40

TRYFUS Kronenzangen 152

TUTTLE Matrizen-Lochzangen 130

**U**

UNIVERSAL Verbandschere 20

UNIVERSAL Ligaturschere 3

UNIVERSAL Kramponzangen 149

UNIVERSAL Sterilisierzangen 108

UNIVERSITY OF MICHIGAN Wurzelheber 66

UNIVERSITY OF MINNESOTA Lippenhalter 27

USA MODEL Scharfe Löffel 23

USA MODEL Anatomische Pinzetten 8

USA MODEL Chirurgische Pinzetten 8

**V**

VANJA Instrumente für plastische Füllungen 122

VEHE Modellierinstrumente 136

VOLKMANN Scharfe Löffel 22

**W**

Wachs, Perzellan - und Modellier 135-138

WAGNER Zahnfleischschere 5

WALDSACHS Kramponzangen 149

WALDRON Drahtbiegezangen 147

WALTER F. BARRY Wurzelheber 69

WALTER Splitterzangen 10

WARDKIRKLAND Instrumente für Parodontologie 86

WARWICK JONES Wurzelheber 71

WEBSTER Nadelhalter 15

WEDELSTAEDT Schmelzinstrumente 89

WEDELSTAEDT Finierinstrumente 109

WEINGART Klammernbiegezangen 151

WESCOTT Mikro-schere 6

WESTON Zementspatel 120

WESTON Instrumente 110

WESTON Zahnsonden 94

WHITE Pollerinstrumente 114

WHITE Flach Hohlmeißel 89

WHITE Schmelzinstrumente 89

WHITE Exkavatore 100

WHITE Instrumente für plastische Füllungen 120-121

WHITE Zahnsonden 90

WHITE Reinigungsinstrumente 78

WHITE HEAD Mundsperrier 25

WHITESIDE Reinigungsinstrumente 80

WHITTEN Reinigungsinstrumente 78

WIEDER Zungendrucker 27

WILLIAMS Instrumente für Plastische Füllungen 121

WILLIGER Scharfe Löffel 23

|  |       |
|--|-------|
| WILLIGER Hämmer                              | 21    |
| WINTER Wurzelheber                           | 69    |
| WISDOM-DOUTURIER Zahnzangen                  | 43    |
| WITZEL Schneidende Instrumente               | 105   |
| WITZEL Zahnzangen                            | 36,58 |
| WITZEL Zahnsonden                            | 95    |
| WOLFF Modellierinstrumente                   | 136   |
| WOODSON Instrumente                          | 110   |
| WOODSON Instrumente für plastische Füllungen | 121   |
| WOODWARD Zahnzangen                          | 48    |
| WOODWARD Wurzelheber                         | 65    |

## Y

|   |     |
|---|-----|
| YOUNG Klammerbiegezangen und ligaturenzange | 148 |
| YOUNG Zungenzangen                          | 28  |
| YOUNGER GOOD Reinigungsinstrumente          | 80  |

## Z

|                               |       |
|-------------------------------|-------|
| ZAHLE Modellierinstrumente    | 135   |
| Zahnzangen                    |       |
| amerikanische Form            | 47-58 |
| Englische Form                | 29-46 |
| ZERFING Reinigungsinstrumente | 78    |
| ZIEBE Kronenzangen            | 152   |





# INDEX DE NUMEROS

## A

|  |         |
|--|---------|
| ABBOT Limpiadores de sarro                                 | 79      |
| ABEL Alicates contantes para ligadures                     | 153     |
| ABRAHAM Bisturios para del paladar                         | 28      |
| ADERER Alicates para ganchos y ligadures                   | 148     |
| ADERER Alicates para doblar para ganchos                   | 151     |
| ADSON - BROWN Pinzas de disección                          | 9       |
| ADSON Pinzas de disección                                  | 9       |
| AINSWORTH Perforadores para dique                          | 130     |
| ANDERSON Alicates para doblar barras                       | 146     |
| ANGLE Alicates para ganchos y ligadures                    | 148     |
| ANGLE Alicates contantes para ligadures                    | 153     |
| APEXO Elevadores para raices                               | 63      |
| ARRINGTON Instrumentos para amalgama, gutapercha y cemento | 110     |
| ARRINGTON Instrumentos para nervios                        | 105     |
| ARRUGA Porta-agujas  | 18      |
| ARRUGA Porta-agujas TC                                     | 14      |
| ASH Instrumentos para obturaciones plasticas               | 119-120 |
| ARTHUR Pinzas para espinas                                 | 10      |

## B

|  |         |
|--|---------|
| BAADE Alicates para coronas y doblar ganchos           | 131     |
| BACKHAUS Pinzas para compresas                         | 12      |
| BALDWIN Instrumentos para obturaciones plasticas       | 119     |
| BARRAQUER Porta-agujas                                 | 18      |
| BEALE Talladores para modelar                          | 138     |
| BEEBEE Tijeras para ligaduras                          | 3       |
| BEIN Elevadores para raices                            | 60,67   |
| BENNET Instrumentos para obturaciones plasticas        | 112     |
| BEYER Pinzas-gubios                                    | 107     |
| BLACK Instrumentos para amalgama, gutapercha y cemento | 110     |
| BLACK Instrumentos cortantes                           | 102,104 |
| BLACK Instrumentos para acabar orificaciones           | 109     |
| BLACK Limpiadores de sarro                             | 81      |
| BLUMENTHAL Pinzas-gubias                               | 106     |
| BOHM Instrumentos para coronas                         | 141     |
| BOYNTON Porta-agujas                                   | 18      |
| BRADC Elevadores para raices                           | 62      |
| BREWER Perforadores para dique                         | 130     |
| BRIAULT Sorda y Exploradores                           | 93      |
| BRUENINGS Abaja-lenguas                                | 26      |
| BRUNS Curetas contantes                                | 22      |
| BUCK Instrumentos para peridonia                       | 82      |
| BUNTING Limpiadores de sarro                           | 80      |
| BUSCH Forceps de extraccion                            | 36      |
| BUXTON Abre-bocas                                      | 24      |

## C

|  |     |
|--|-----|
| Calibradores                                       | 143 |
| CANFIELD Bisturios para del paladar                | 28  |
| CASTROVIEJO Porta-agujas                           | 18  |
| CASTROVIEJO-BARRAQUER Porta-agujas                 | 18  |
| CESPA Espatula para cemento                        | 128 |
| CHEATLE Pinzas para esterilizacion                 | 108 |
| CLEVELAND Pinzas-gubias                            | 107 |
| CLEVELAND GARDENER Pinzas-gubias                   | 107 |
| CLEVELAND Instrumentos para obturaciones plasticas | 121 |
| CLEVELAND Limpiadores de sarro                     | 78  |
| COGSWELL Elevadores para raices                    | 63  |
| COHEN Forceps de extraccion                        | 42  |

|  |       |
|--|-------|
| COLEMAN Elevadores para raices             | 68    |
| COLLIER Porta-agujas                       | 15    |
| COLLIN Abaja-lengus                        | 26    |
| COLLIN Pinzas tira-lingua                  | 28    |
| COUPLAND Elevadores para raices            | 65-66 |
| CRANE Elevadores para raices               | 66    |
| CRANE-KAPLAN Instrumentos para periodoncia | 87    |
| CRILE Pinzas hemostaticas                  | 12    |
| CRILE Porta-agujas                         | 17    |
| CRILE-MURRAY Porta-agujas                  | 16    |
| CRILEWOOD Porta-agujas                     | 16    |
| CRILEWOOD Porta-agujas TC                  | 14    |
| CRYER Forceps de extracción                | 55    |
| CRYER Elevadores para raices               | 64,67 |
| CUMINE Limpiadores de sarro                | 79    |
| CURTIN Elevadores para raices              | 62    |

## D

|   |       |
|---|-------|
| DARBY-PERRY Limpiadores de sarro                          | 78    |
| DAVIS Pinzas para esterilizacion                          | 108   |
| DAY Bisturios para del paladar                            | 28    |
| DEANS Tijeras para encias                                 | 5     |
| DEAVER Tijeras para cirugia                               | 1     |
| DENHART Abre-bocas  | 24    |
| Forceps de extracción                                     |       |
| forma Americano   | 47-58 |
| forma Inglesa   | 29-46 |
| DERF Porta-agujas   | 15    |
| DERF Porta-agujas TC                                      | 14    |
| DIDNER Porta-matrices                                     | 129   |
| DIFFENBACH Pinzas hemostaticas                            | 11    |
| DOYEN Abre-bocas  | 24    |
| DOYEN Abaja-lenguas                                       | 26    |
| DUMONT Alicates contantes y alicates para doblar alambres | 145   |
| DUMONT Alicates de picos chatos                           | 145   |
| DURHAM Agujas para del paladar                            | 28    |

## E

|  |     |
|--|-----|
| EDWARDS Instrumentos para obturaciones plasticas | 119 |
| ENGLISH Pinzas para compresas                    | 12  |
| ERMERT Talladores para modelar                   | 138 |
| EVANS Talladores para modelar                    | 137 |

## F

|   |           |
|---|-----------|
| FAHNENSTOCK Cuchillos para cera                                 | 139       |
| FEILCHENFELD Pinzas para espinas                                | 10        |
| FERGUSON Abre-bocas   | 24        |
| FERRIS SMITH Porta-agujas                                       | 16        |
| FISCHER Alicates para doblar barros                             | 146       |
| FISCHER Alicates para ganchos y ligadures                       | 148       |
| FJELDSTAD Talladores para modelar                               | 136       |
| FLAGG Pinzas para algodón y curaciones                          | 75        |
| FLESCH Forceps de extracción                                    | 54        |
| FLOHR Elevadores raices   | 60-68, 71 |
| FOSTER-FLAGG Instrumentos para amalgama, gutta percha y cemento | 110       |
| FRAHM Talladores para modelar                                   | 137       |
| FRENZEL Abaja-lenguas   | 26        |
| FREVERT Alicates para ensanchar coronas                         | 153       |
| FRIEDMAN Excavadores  | 99        |
| FRIEDMAN Elevadores para raices                                 | 66,71     |
| FRIEDMAN Pinzas-gubias  | 106       |
| FURRER Alicates para quitar anillos de cobre y puentes          | 150       |

## G

|  |     |
|--|-----|
| GILLIES Pinzas-agujas                      | 17  |
| GILLET Excavadores                         | 97  |
| GLOBE Limpiadores de sarro                 | 81  |
| GOLDMAN FOX pinza per tessuti              | 7   |
| GOLDMAN FOX Tijeras para cirugia           | 2   |
| GORDON Alicates para contourmen            | 153 |
| GOSLEE Alicates de picos chatos            | 143 |
| GLOSS-MAIER Pinzas para vandajes y tapones | 13  |
| GUENTHER Limpiadores de sarro              | 79  |
| GUY Forceps de extracción                  | 40  |

## H

|   |       |
|---|-------|
| HALSEY Porta-agujas   | 15    |
| HALSTEAD Pinzas hemostaticas                                  | 11    |
| HARRIS Forceps de extracción                                  | 49    |
| HARTMANN Pinzas hemostaticas                                  | 11    |
| HAUBEIL Instrumentos para amalgama, gutta percha y cemento    | 111   |
| HEIDBRINK Elevadores para raices                              | 63    |
| HEIDEMANN Instrumentos para obturaciones plasticas            | 119   |
| HEISTER Abre-bocas  | 24    |
| HEGAR-BAUMGARTNER Porta-agujas                                | 14-15 |
| HENAKAK Forceps de extracción                                 | 48    |
| HERBST Alicates para coronas                                  | 153   |
| HOLLENBACK Instrumentos para amalgama, gutta percha y cemento | 111   |
| HOSPITAL Cortadores para esmalte                              | 89    |
| HOW Alicates para coronas                                     | 152   |
| HULL Forceps de extraccion                                    | 53    |
| HUNT Espatulas para gutta-percha                              | 126   |
| HUNTER Pinzas para espinos                                    | 10    |
| HYLIN Elevadores para raices                                  | 68    |
| HYLIN Talladores para cera y para modelar                     | 135   |

## I

|                                   |         |
|-----------------------------------|---------|
| Instrumentos                      |         |
| para amalgama y cemento           | 110,113 |
| para coronas                      | 140-142 |
| para goma dique                   | 130-133 |
| para nervios                      | 105     |
| para obturaciones plasticas       | 115-122 |
| para periodoncia                  | 82-88   |
| IVORY Instrumentos para amalgama  | 113     |
| IVORY Espátulas para gutta-percha | 126     |
| IVORY Porta-matrices              | 129     |
| IVORY Perforadores para dique     | 130-131 |
| IVORY Separadores                 | 129     |

## J

|   |     |
|---|-----|
| JAQUETTE Limpiadores de sarro             | 78  |
| JAQUETTE Instrumentos para periodoncia    | 82  |
| Jeringas Amalgam                          | 113 |
| JOHNSON Alicates contantes para ligadures | 153 |
| JONES Pinzas para compresas               | 12  |
| JOSEPH Tijeras pas cirugia                | 2   |

## K

|  |    |
|--|----|
| KELLS Forceps de extracción            | 53 |
| KELLY Pinzas hemostaticas              | 11 |
| KELLY Tijeras para encias              | 4  |
| KIRKLAND Instrumentos para periodoncia | 87 |

|   |     |
|---|-----|
| KLEIN Forceps de extracción                 | 46  |
| KOCHER Pinzas hemostáticas                  | 12  |
| KOERBITZ Alicates para doblar ganchos       | 151 |
| KRENN Instrumentos para quitar obturaciones | 114 |

## L

|   |         |
|---|---------|
| LADMORE Instrumentos para obstrucciones<br>plásticas        | 116     |
| LA-GRANGE Tijeras para encías                               | 4       |
| LANGE Sondas y exploradores                                 | 94      |
| LANGENBECK Dadeles  | 25      |
| LANGENBECK Alicates de picos chatos                         | 143-144 |
| LAWRENCE-READ Forceps de extracción                         | 38,45   |
| LECLUSE Elevadores para raíces                              | 70      |
| LECRON Talladores para cera y para modelar                  | 135     |
| LE MEE Abaja-lenguas  | 27      |
| LESSMANN Cuchrilla para funder cera                         | 139     |
| LEWIS Instrumentos para amalgama,<br>gutta percha y cemento | 110     |
| LINESMANN Instrumentos para obturaciones<br>plásticas       | 122     |
| LISTER Tijeras para vandagis                                | 20      |
| LITTATUER Tijeras para ligaduras                            | 3       |
| LOCKLIN Tijeras para encías                                 | 4       |
| LONDON-COLLEGE Pinzas para algodón y<br>curaciones          | 74      |
| LONDON-HOSPITAL Elevadores para raíces                      | 68      |
| LOOS Elevadores para raíces                                 | 70      |
| LORNA Pinzas para compresas                                 | 12      |

## M

|  |         |
|--|---------|
| MACMILLAN Elevadores para raíces                         | 66      |
| MALL Instrumentos para amalgama y<br>cemento             | 11      |
| MALL-RONDOFLEX Espátula para cemento                     | 127     |
| MARTINI Cucharillas cortantes                            | 23      |
| MATHIEU Porta-agujas                                     | 17      |
| MATHIEU Porta-agujas TC                                  | 14      |
| MAYO HEGAR Porta-agujas                                  | 16      |
| MAYO HEGAR Porta-agujas TC                               | 14      |
| MAYO Tijeras para cirugía                                | 2       |
| MAYO Abaja-lenguas                                       | 26      |
| McCALL Limpiadores de sarro                              | 80      |
| McKELLOPS Alicates para doblar barras                    | 147     |
| MEAD Pinzas-gubias                                       | 106     |
| MEAD Forceps de extracción                               | 41      |
| MEAD Martillos y Mazos                                   | 21      |
| MERCITAN Instrumentos para periodoncia                   | 80      |
| MERIAM Pinzas para algodón y curaciones                  | 75      |
| MERSHAM Instrumentos para coronas                        | 131     |
| MESSER Instrumentos para obturaciones                    | 119     |
| METZENBAUM Tijeras para cirugía                          | 2       |
| MICRO-MOSQUITO Pinzas hemostáticas                       | 11      |
| MILLER Instrumentos para coronas                         | 140     |
| MILLER-APEXO Limpiadores de sarro                        | 61      |
| MILWAUKEE Forceps de extracción                          | 48      |
| MINI-FRIEDMANN Pinzas-gubias                             | 106     |
| Espejos de boca y Mangos                                 | 73      |
| MITCHELL Limpiadores de sarro                            | 79      |
| MITCHELL Cortadores para esmalte                         | 89      |
| MODELL-AMALG Instrumentos                                | 111     |
| MOD MARTIN Instrumentos para quitar<br>obstrucciones     | 114     |
| MOD PLASTIC Instrumentos para<br>obstrucciones plásticas | 117-118 |
| MOD-SPATULA Instrumentos para<br>obstrucciones plásticas | 115-116 |
| MODE USA Instrumentos                                    | 112     |
| MOLT Abre-bocas  | 24      |
| MONFORT Instrumentos para coronas                        | 142     |
| MOORE Limpiadores de sarro                               | 78      |
| MUEHLEMANN Limpiadores de sarro                          | 81      |

## N

|                                  |       |
|----------------------------------|-------|
| NEIVERT Porta-agujas             | 15    |
| NEUMANN Tijeras para encías      | 4     |
| NEVIUS Forceps de extracción     | 53,54 |
| NOYES Mikro Tijeras              | 6     |
| NORMAL Forceps de extracción     | 48    |
| NORTHBENT Tijeras para ligaduras | 3     |

## O

|                                      |       |
|--------------------------------------|-------|
| OGDEN-FELSCH Forceps de extracción   | 39    |
| OLIVER Alicates para doblar alambres | 147   |
| OLSEN-HEGAR Porta-agujas             | 16-17 |
| OLSEN-HEGAR Porta-agujas TC          | 14    |
| OPPIE McCALL Limpiadores de sarro    | 78    |

## P

|  |     |
|--|-----|
| PALMER Pinzas porta-clamps para dique            | 130 |
| PARMLY Forceps de extracción                     | 51  |
| PARTSCH Martillos y Mazos                        | 21  |
| PASSO Forceps de extracción                      | 39  |
| PEAN Pinzas hemostáticas                         | 12  |
| PESSO Alicates para cuelles de coronas           | 151 |
| PESSO Alicates para coronas                      | 152 |
| PEET Pinzas para espinas                         | 10  |
| PHYSICK Forceps de extracción                    | 49  |
| PICHLER Instrumento para acabar<br>orificaciones | 109 |
| POTT Elevadores para raíces                      | 70  |
| POTTS-SMITH Pinzas de disección                  | 9   |
| POTTS-SMITH Pinzas de disección on dientes       | 9   |

## Q

|                            |   |
|----------------------------|---|
| QUINBY Tijeras para encías | 4 |
|----------------------------|---|

## R

|   |     |
|---|-----|
| RALK Pinzas para espinas                  | 10  |
| REVERDIN Agujas                           | 19  |
| REYNOLDS Alicates para contourmen         | 153 |
| RIEGNER Talladores para modelar           | 137 |
| ROACH Talladores para modelar             | 136 |
| ROBINSON Alicates para cuelles de coronas | 151 |
| ROGGE Pinzas para esterilización          | 108 |
| ROSER-KONIG Abre-bocas                    | 24  |

## S

|  |       |
|--|-------|
| SANDERS Instrumentos para periodoncia              | 82    |
| SCHAEDLE Pinzas para compresas                     | 12    |
| SCHARMANN Limpiadores de sarro                     | 80    |
| SCHEDE cortantes                                   | 22    |
| SCHMECKEBER-APEXO Elevadores para<br>raíces        | 60    |
| SCHWARZ Alicates para doblar alambres y<br>baros   | 146   |
| SCHWARZ Alicates para doblar ganchos               | 151   |
| SCHWEIZER MODEL Sondas y exploradores              | 92    |
| SELDIN Elevadores para raíces                      | 61-62 |
| SIMPLEX Separadores para labios                    | 27    |
| SHORTBENT Tijeras para ligaduras                   | 3     |
| SMITH Tijeras para vandagis                        | 20    |
| SMITH Instrumentos para obstrucciones<br>plásticas | 119   |
| SPENCER Tijeras para ligaduras                     | 3     |
| SPRATT Cucharillas cortantes                       | 22    |
| STADLER Alicates para doblar alambres              | 147   |
| Standard Forceps de extracción                     | 48    |

|                                   |       |
|-----------------------------------|-------|
| STERNBERG Separadores para labios | 27    |
| STIEGLITZ Pinzas para espinas     | 10    |
| STIKSA Forceps de extracción      | 42    |
| STOKES Pinzas porta para dique    | 130   |
| STOUT Elevadores para raíces      | 62-63 |
| SWING Forceps de extracción       | 57    |

## T

|  |     |
|--|-----|
| THOMAS Forceps de extracción                       | 52  |
| THUERRIEGEL Instrumentos Cortantes                 | 105 |
| TOFFLEMIRE Porta-matrices                          | 129 |
| TOMATI Pinzas per tessuti                          | 7   |
| TOMES Forceps de extracción                        | 52  |
| TOMPKINS Limpiadores de sarro                      | 81  |
| TOMPKINS Instrumentos para acabar<br>orificaciones | 109 |
| TRIPLEX Alicates para coronas                      | 153 |
| TROTTER Forceps de extracción                      | 40  |
| TRYFUS Alicates para coronas                       | 152 |
| TUTTLE Perforador para matrices                    | 130 |

## U

|  |     |
|--|-----|
| UNIVERSAL Tijeras para verdagis                    | 20  |
| UNIVERSAL Tijeras para ligaduras                   | 3   |
| UNIVERSAL Alicates para espigas                    | 149 |
| UNIVERSAL Pinzas para esterilización               | 108 |
| UNIVERSITY OF MICHIGAN Elevadores para<br>raíces   | 66  |
| UNIVERSITY of MINNESOTA Separator para<br>mejillas | 27  |
| USA MODEL Cucharillas cortantes                    | 23  |
| USA MODEL Pinzas de disección                      | 8   |
| USA MODEL Pinzas de disección condientes           | 8   |

## V

|   |     |
|---|-----|
| VAJNA Instrumentos para obturaciones<br>plásticas | 122 |
| VEHE Talladores para modelar                      | 136 |
| VOLKMANN Cucharillas cortantes                    | 22  |

## W

|   |         |
|---|---------|
| WAGNER Tijeras para encías                            | 5       |
| WALDSACHS Alicates universales para<br>espigas        | 149     |
| WALDRON Alicates para doblar alambres                 | 147     |
| WALTER F. BARRY Elevadores para raíces                | 69      |
| WALTER Pinzas para espinas                            | 10      |
| WARDKIRKLAND Instrumentos para<br>periodoncia         | 86      |
| WARWICK JONES Elevadores para raíces                  | 71      |
| WEBSTER Porta-agujas                                  | 15      |
| WEDELSTAEDT cortadores para esmalte                   | 89      |
| WEDELSTAEDT Instrumentos para acabar<br>orificaciones | 109     |
| WEINGART Alicates para doblar ganchos                 | 151     |
| WESCOTT Micro-Tijeras                                 | 6       |
| WESTON Espátulas para cemento                         | 128     |
| WESTON Instrumentos para amalgama                     | 110     |
| WESTON Exploradores                                   | 94      |
| WHITE Brunidores                                      | 114     |
| WHITE Cortadores para esmalte                         | 89      |
| WHITE Cinceles  | 89      |
| WHITE Excavadores                                     | 100     |
| WHITE Instrumentos para obturaciones<br>plásticas     | 120-121 |



|  |       |
|--|-------|
| WHITE Sondas y exploradores                          | 90    |
| WHITE Limpiadores de sarro                           | 78    |
| WHITE HEAD Abre-bocas                                | 25    |
| WHITESIDE Limpiadores de sarro                       | 80    |
| WHITTEN Limpiadores de sarro                         | 78    |
| WIEDER Abaja-lenguas                                 | 27    |
| WILLIAMS Instrumentos para obturaciones<br>plasticas | 121   |
| WILLIGER Cucharillas cortantes                       | 23    |
| WILLIGER Martillos y Mazos                           | 21    |
| WINTER Elevadores para raices                        | 69    |
| WISDOM-ROUTURIER Forceps de extracción               | 43    |
| WITZEL Instrumentos cortantes                        | 105   |
| WITZEL Forceps de extraccion                         | 36,58 |
| WITZEL Sondas y exploradores                         | 95    |
| WOLFF Talladores para modelar                        | 186   |
| WOODSON Instrumentos                                 | 110   |
| WOODSON Instrumentos para obturaciones<br>plasticas  | 121   |
| WOODWARD Forceps de extracción                       | 48    |
| WOODWARD Elevadores para raices                      | 65    |

## Y

|   |     |
|---|-----|
| YOUNG Alicates para ganchos y ligaduras | 148 |
| YOUNG Pinzas tira-lengua                | 28  |
| YOUNGER GOOD Limpiadores de sarro       | 80  |

## Z

|                               |     |
|-------------------------------|-----|
| ZAHLE Talladores para modelar | 135 |
| ZERFING Limpiadores de sarro  | 78  |
| ZIEBE Alicates para coronas   | 152 |

