



Surgical Technique

Hansson DC Nail System[®]

With Hansson
Twin Hook[®]

Swemac

Hansson DC Nail System[®]

The Hansson Dynamic Cephalomedullary (DC) Nail System is an intramedullary system designed to address trochanteric, subtrochanteric and combined trochanteric-subtrochanteric fractures. The system incorporates new technologies covered by seven patents.

The Hansson DC Nail System provides three different types of intramedullary Nails (Short, Superior Lock & Long) which can be combined with either the Hansson Twin Hook or a Lag Screw for fixation in the femoral head. Both are proven fixation methods when treating hip fractures.

The intramedullary Nails are available in different sizes to give the surgeon full flexibility in selecting the most appropriate implant combination based on the fracture pattern and patient anatomy. The instrumentation provided allows for a minimally invasive surgical procedure and the ability to incorporate axial dynamisation along the axis of the femoral shaft through the creation of a notch in the lateral femoral cortex.



**Advanced
Dynamisation**

A new dynamic function – Advanced Dynamisation

Allows continuous compression along the axis of the femoral shaft through the creation of a notch in the lateral femoral cortex.

A new type of nail – Superior Lock Nail

Combines the surgical simplicity of a short nail with the advantages of a long nail.

Proven proximal fixation – Hansson Twin Hook®

Provides enhanced rotational stability.
Requires no rotational force during insertion.

Lag Screw with a self-cutting compression thread

Designed to overcome the strength reduction in the cancellous bone caused by osteopaenia or osteoporosis.

Next generation instrumentation

Includes innovative instrumentation designed to allow a safe and minimally invasive procedure with reduced soft tissue irritation.

Product overview

Hansson DC Nails



Short Nail

- Proximal diameter 15.9 mm
- Distal diameter 11 mm
- One length (180 mm)
- CCD angle 125° (*)
- Medial/Lateral (ML) bend 4°
- Universal left and right use

Superior Lock (SL) Nail

- Proximal diameter 15.9 mm
- Distal diameter 10 mm (tapers to 9.5 mm distal to the distal locking hole)
- Lengths 240-480 mm in 20 mm increments (left & right)
- CCD angle 125° (*)
- Medial/Lateral (ML) bend 4°
- Radius of curvature (ROC) 1250 mm
- 3° bend at distal tip
- Distal locking hole is located at the same level as the short Nail and is locked using the Targeting Device

Long Nail

- Proximal diameter 15.9 mm
- Distal diameter 11 mm
- Lengths 240-480 mm in 20 mm increments (left & right)
- CCD angle 125° (*)
- Medial/Lateral (ML) bend 4°
- Radius of curvature (ROC) 1450 mm
- 3° bend at distal tip
- Anteversion 15°

** At market introduction all Nails are only available with a CCD angle of 125°. However the instrumentation is designed for the future addition of 120° and 130° Nails.*

End Cap

End Caps are provided in four different sizes: +0 mm, +5 mm, +10 mm and +15 mm.

Pre-loaded Set Screw

All Hansson DC Nails are supplied with the Set Screw preassembled. The Nail and Set Screw are offered as one unit under one article number in sterile packaging,

Locking Screws

Self-cutting and fully threaded $\varnothing 5$ mm Locking Screws are offered in 2 mm increments from 26 to 70 mm and in 5 mm increments from 75 to 125 mm.

Hansson Twin Hook[®]

The Hansson Twin Hook has a diameter of 10.75 mm and offered in lengths from 75 to 130 mm in 5 mm increments.

Preparation and Incision

Pre-operative planning

Safe use of the Hansson DC Nail System requires the surgeon to have extensive knowledge about the indications and contraindications, the implants, the methods of application, the instrumentation and the recommended surgical technique of the device.

Indications

The Hansson DC Nail System is indicated for fixation of stable and unstable trochanteric fractures, including but not limited to non-unions, malunions and actual or impending pathologic fractures of the proximal femur. Long and Superior Lock Nails are additionally indicated for subtrochanteric fractures. Long Nails are furthermore indicated for fractures of the basilar neck and shaft fractures.

Contraindications

The surgeon's education, training and professional judgement must be relied upon to choose the most appropriate device and treatment. Conditions presenting an increased risk of failure include:

- Fixation of subtrochanteric fractures with the Short Nail (180 mm).
- Any active or suspected latent infection, sepsis or marked local inflammation in or around the surgical area.
- Material sensitivity, documented or suspected.
- Physical interference with other implants during implantation or use.
- Compromised vascularity, inadequate skin or neurovascular status.

Caution: The surgeon must inform the patient about the use, limitations and possible adverse effects of the implants. The patient must also be warned that the implants/treatment might fail if he/she neglect the postoperative care instructions.

Patient positioning

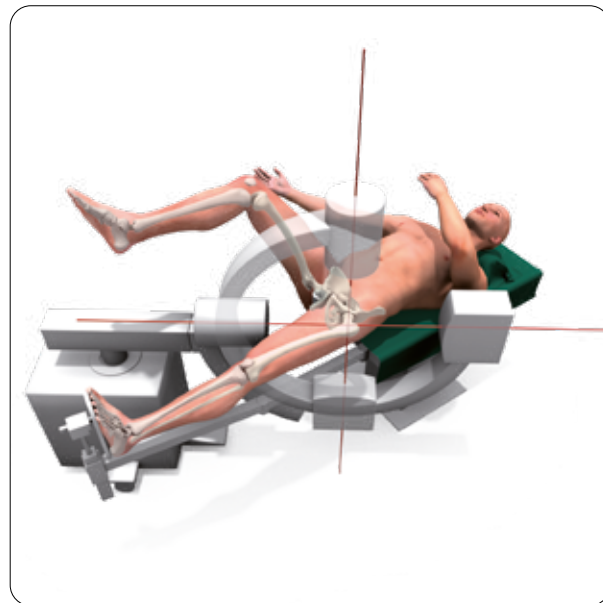

Place the patient supine on a fracture extension table. Position the unaffected leg with the hip in flexion and abduction to allow access for the C-arm. There must be enough room to allow for interoperative adjustments to achieve both an anteroposterior (AP) and a lateral view.

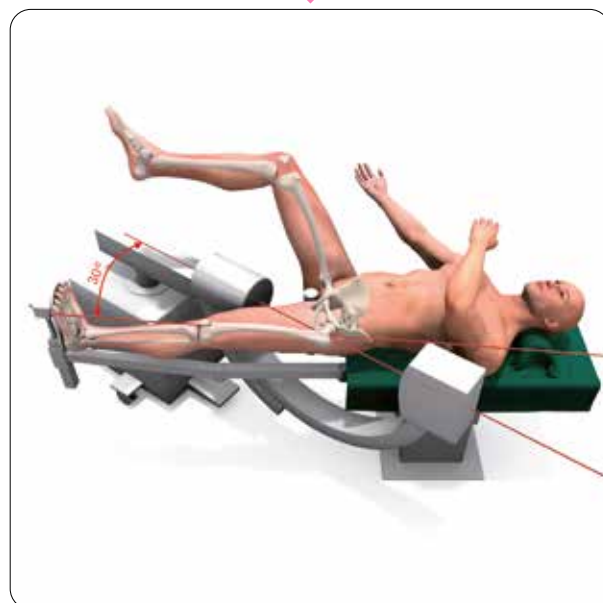

It is important to obtain a true lateral view of the femoral neck and the femoral head. During the procedure, the C-arm will need to be moved so both the proximal and distal ends of the Nail are visible.

Reduction

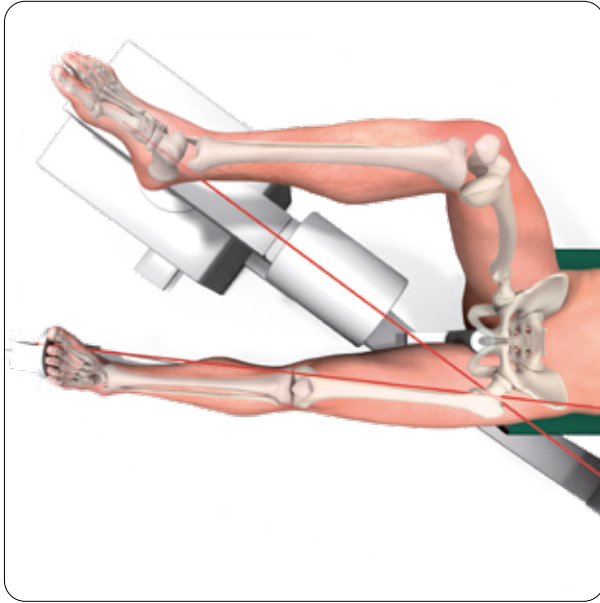

The fracture is reduced by longitudinal traction, abduction and internal rotation (if needed) on the fracture table. The fracture position should be in an anatomical position.

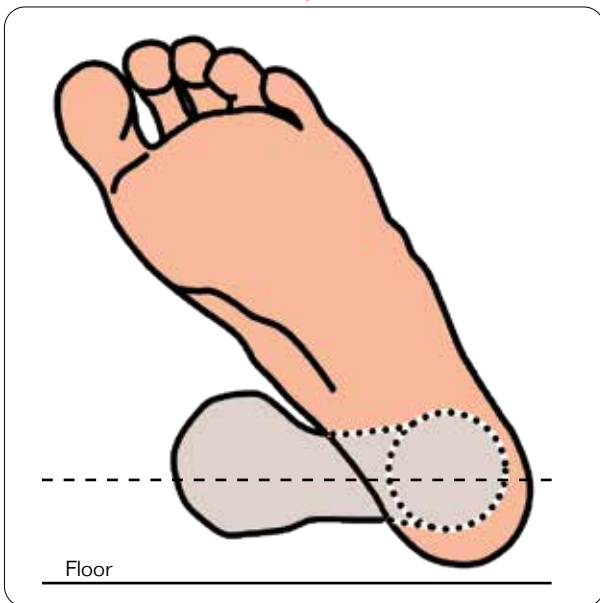

The proximal femur should ideally be positioned so that the head and neck are parallel to the floor. The patella should be in a horizontal or slightly internally rotated position. The patient is then prepared and draped. In unstable fractures, Guide Wires can be placed to temporarily stabilise the reduced fragments.

Make incision

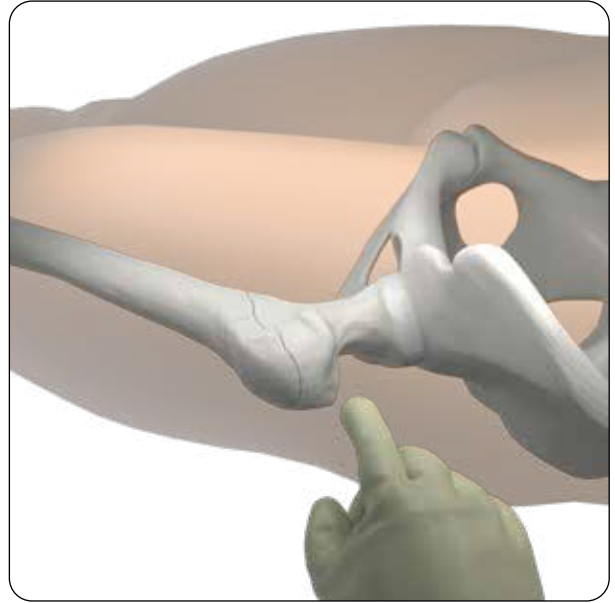

The tip of the greater trochanter is palpated and a 20-30 mm skin incision is made from the greater trochanter towards the iliac crest.

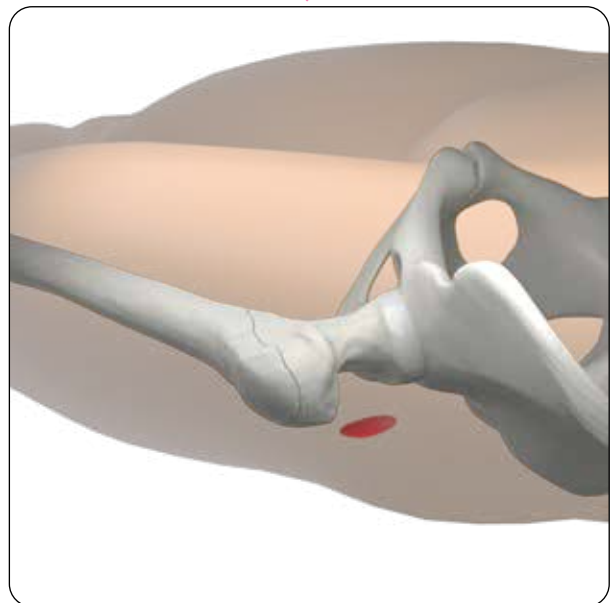

The tip of the greater trochanter is exposed by making a small incision through the fascia lata and splitting the gluteal muscle immediately above the tip of the greater trochanter.

Entry Point and Opening

Option #1 - Threaded Guide Wire and Opening Reamer

Entry point and Guide Wire insertion

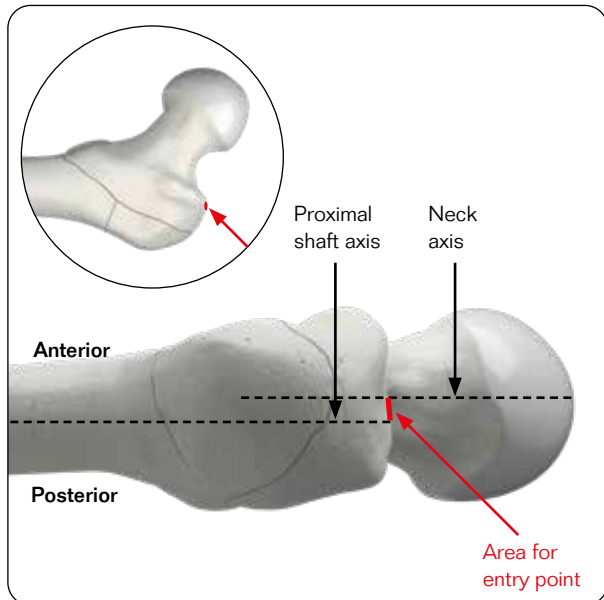

The entry point in the AP view is located at the tip of the greater trochanter. In the lateral view, the optimal entry point is determined by considering the fit of the Nail in the proximal diaphysis as well as the Hansson Twin Hook placement in the femoral head. The optimal entry point is typically located in the anterior portion of the greater trochanter but in smaller femurs or where the intramedullary canal is narrow, a more posterior position may be chosen.

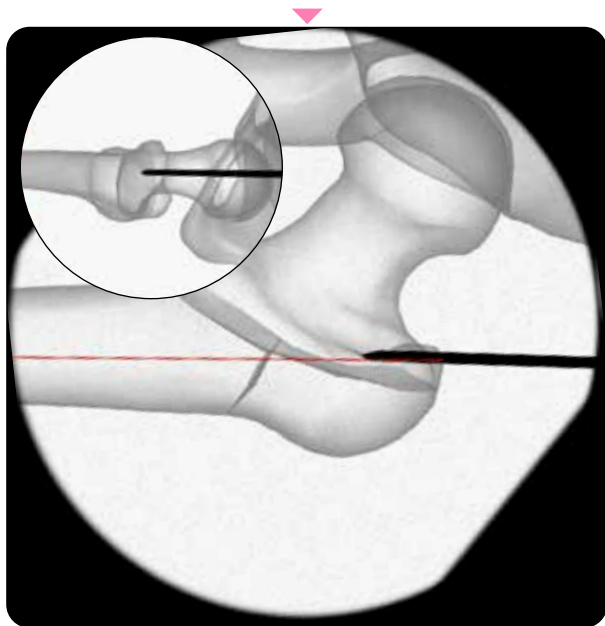

A Threaded Guide Wire Ø3.5 mm (151.6002) is placed on the tip of the greater trochanter and aligned with the femoral canal in both the AP and lateral views. The Guide Wire is introduced using image intensification. An optional x-ray Positioning Template (62-3101) which can be placed onto the image intensifier is available.

Note: A Threaded Guide Wire Ø3.2 mm (151.6003) is also provided for cases where a suitable wire driver for the Ø3.5 mm Guide Wire is not available.

Introduction of Guide Sleeve for Opening Reamer

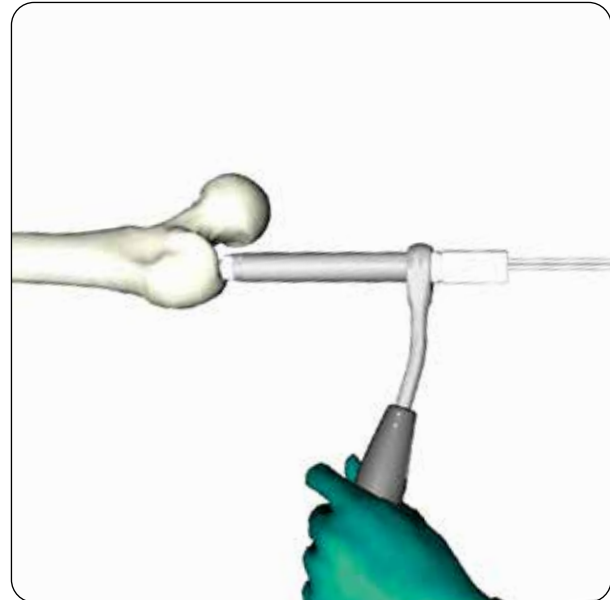

The Repositioning Guide (151.2001) is inserted into the Guide Sleeve for Opening Reamer (151.2002) and introduced over the Threaded Guide Wire down to the greater trochanter. The tip of the Repositioning Guide will serve as a trocar.

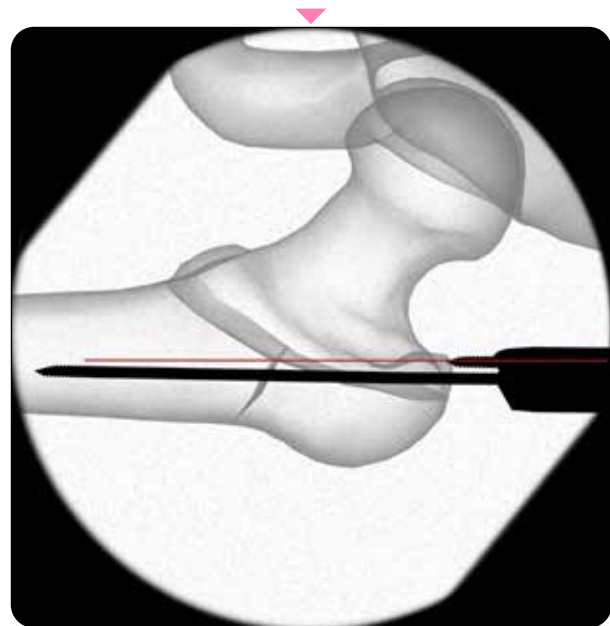

If the Threaded Guide Wire is not in the correct position it can be corrected with the Repositioning Guide. The new position is targeted by rotating the Repositioning Guide to the desired position and a second Threaded Guide Wire is inserted. The initial Guide Wire is then removed.

Opening reaming

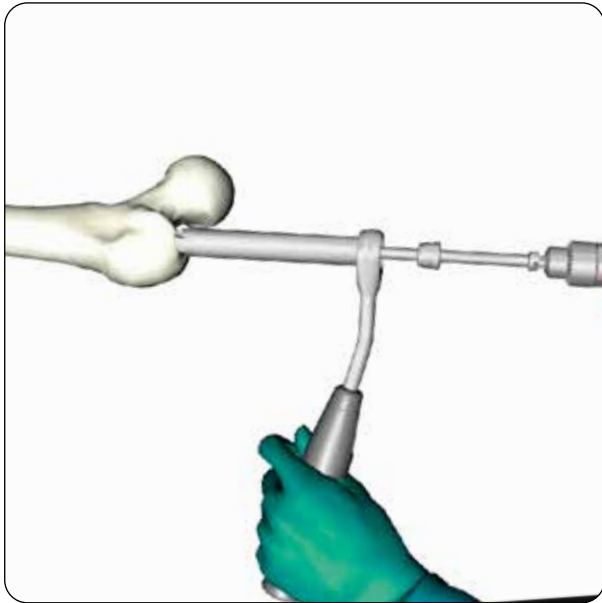

The Repositioning Guide is removed and the Opening Reamer (151.3001) is introduced over the Threaded Guide Wire and into the Guide Sleeve for Opening Reamer. The Opening Reamer is advanced into the bone until the stop on the Reamer comes into contact with the Guide Sleeve and it is prevented from advancing any further.

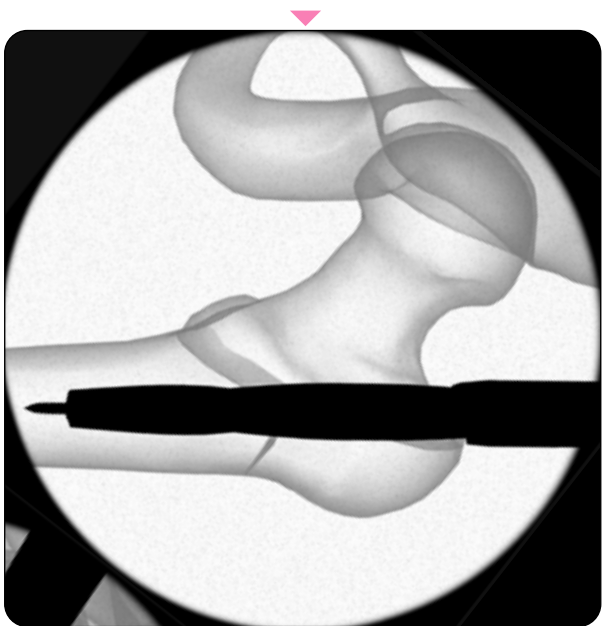

Note: the Opening Reamer can be inserted by hand using the T-handle with Zimmer Hall Coupling (151.0004) or by power.

Optional: Reaming the medullary canal with a Flexible Intramedullary Reamer

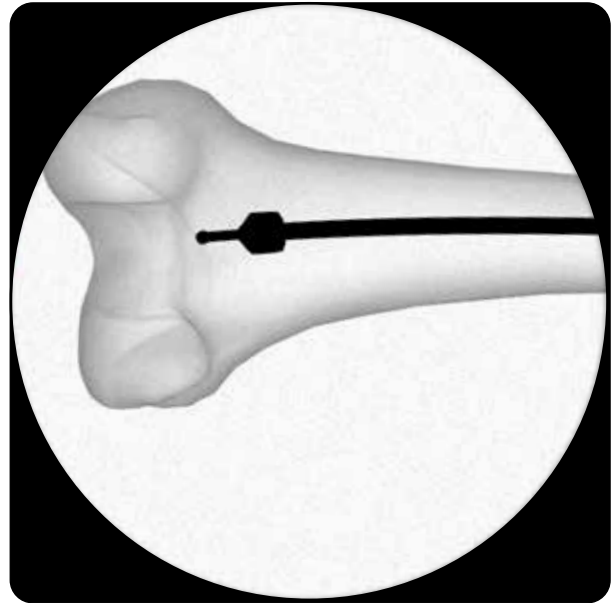

If reaming of the subtrochanteric and diaphyseal regions are required, it is essential to use the Guide Wire for Opening Reamer (Ball Tip Guide Wire) (151.6001) provided with the Hansson DC Nail System. It has specific markings that are calibrated with the Measuring Sleeve for Long Nail (151.7001) and a specific chamfer to prevent disruption of the preloaded cannulated Set Screw on Nail insertion and/or removal of the Wire. A Reduction Spoon (151.0006) is available to facilitate the introduction of the Guide Wire for Opening Reamer (Ball Tip Guide Wire) past the fracture site and into the distal fragments.

Flexible reamers are not provided with the Hansson DC Nail System. The surgeon should therefore ensure that the flexible reamers used are suitable for the Guide Wire for Opening Reamer (Ball Tip Guide Wire). The Guide Wire has a shaft diameter of 3 mm and a spherical 4 mm ball tip.

Incrementally ream the femur up to a diameter 2 mm larger than the distal diameter of the Nail i.e. 13 mm for the 11 mm Short Nail and Long Nails, 11.5 mm for the 10 mm SL Nail (tapers to 9.5 mm distal to the distal locking hole). Image intensification should be used for guidance during these steps.

If the patient has a narrow intramedullary canal in the subtrochanteric region, it is possible to ream the proximal part of the intramedullary canal with a 16 mm flexible intramedullary reamer.

Note: Do not use the Threaded Guide Wire in combination with flexible intramedullary reamers.

Option #2 - Curved Awl and Opening Reamer

Entry point and Curved Awl insertion

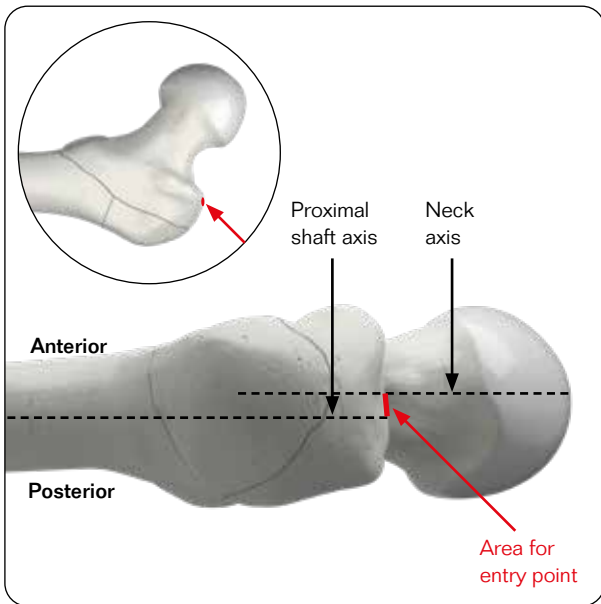

The entry point in the AP view is located at the tip of the greater trochanter. In the lateral view, the optimal entry point is determined by considering the fit of the Nail in the proximal diaphysis as well as the Hansson Twin Hook placement in the femoral head. The optimal entry point is typically located in the anterior portion of the greater trochanter but in smaller femurs or where the intramedullary canal is narrow, a more posterior position may be chosen.

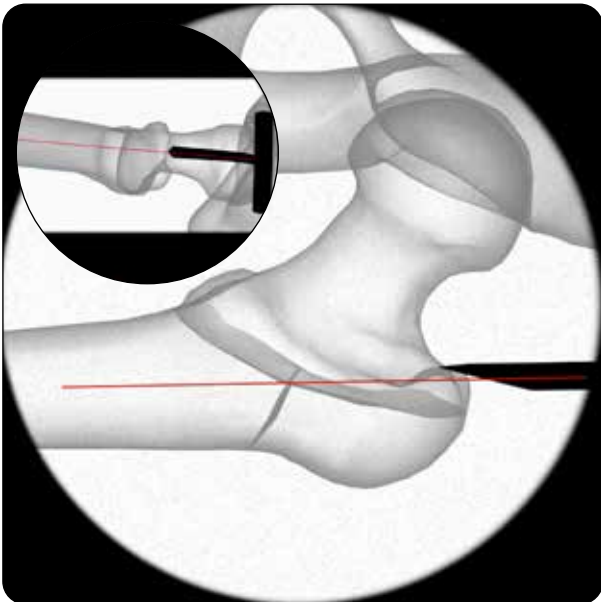

The Curved Awl (151.0001) is placed on the tip of the greater trochanter and aligned with the femoral canal in both the AP and lateral views. The Curved Awl is introduced using image intensification. An optional x-ray Positioning Template (62-3101) which can be placed onto the image intensifier is available.

Opening the tip of the greater trochanter

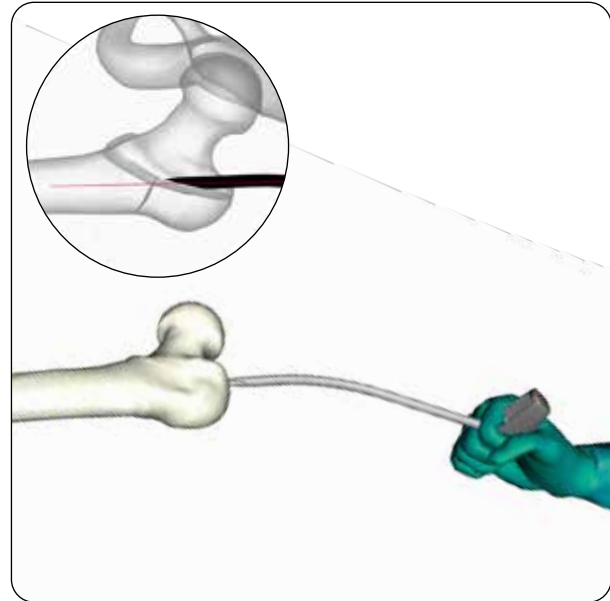

Once the correct position is verified, the cortex is opened by twisting the handle of the Curved Awl and driving it into the femur.

Note: The Threaded Guide Wires cannot be used with the Curved Awl.

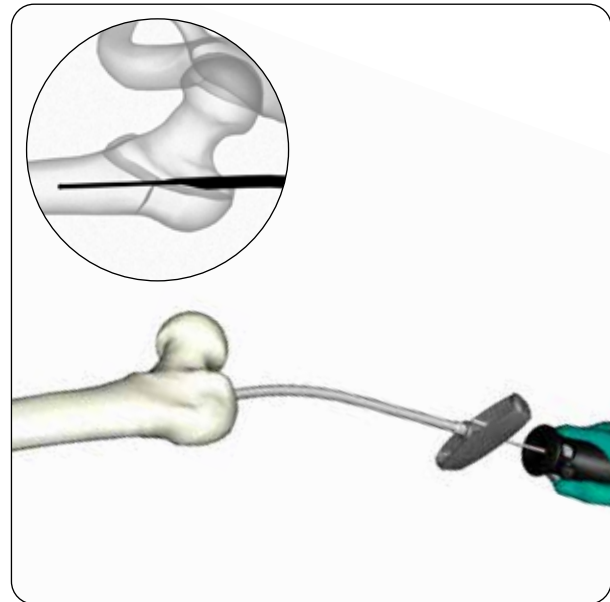

The Guide Wire for Opening Reamer (151.6001) (Ball Tip Guide Wire) is inserted through the Curved Awl using the Guide Wire Driver - Handle (151.0002).

Note: If using an SL or Long Nail, measure for selection of the Nail at this stage before using the Opening Reamer. Please see page 12 for more details.

Opening reaming

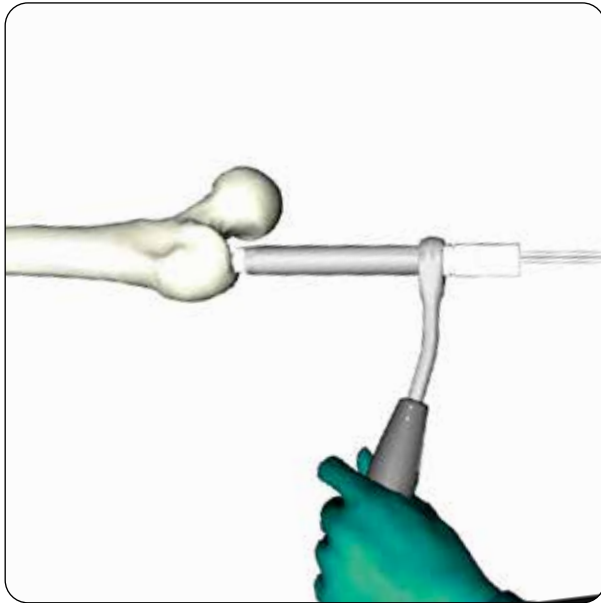

The Repositioning Guide (151.2001) is inserted into the Guide Sleeve for Opening Reamer (151.2002) and introduced over the Guide Wire for Opening Reamer (Ball Tip Guide Wire) down to the greater trochanter. The tip of the Repositioning Guide will serve as a trocar.

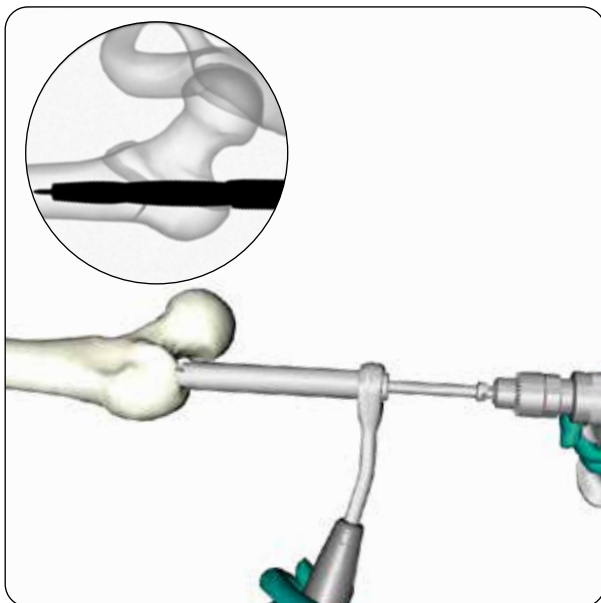

The Repositioning Guide is then removed and the Opening Reamer is introduced over the Guide Wire and into the Guide Sleeve. The Opening Reamer is advanced into the bone until the stop on the reamer comes into contact with the Guide Sleeve and it is prevented from advancing any further.

Note: The Opening Reamer can be inserted by hand using the T-handle with Zimmer Hall Coupling (151.0004) or by power.

Optional: Reaming the medullary canal with a Flexible Intramedullary Reamer

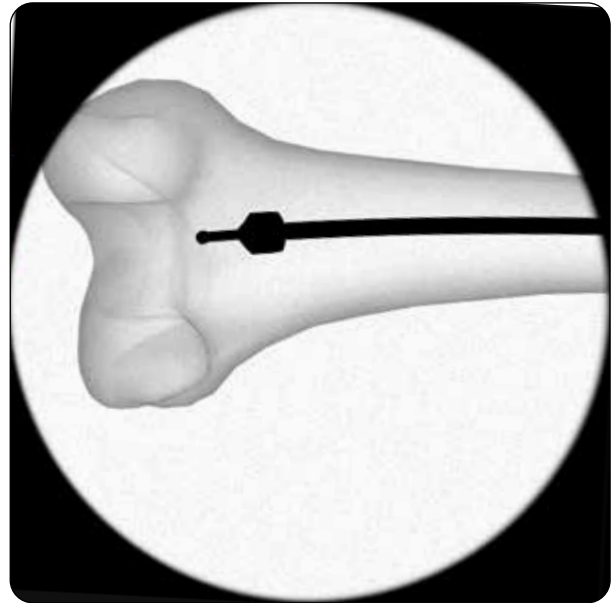

If reaming of the subtrochanteric and diaphyseal regions are required, it is essential to use the Guide Wire for Opening Reamer (Ball Tip Guide Wire) (151.6001) provided with the Hansson DC Nail System. It has specific markings that are calibrated with the Measuring Sleeve for Long Nail (151.7001) and a specific chamfer to prevent disruption of the preloaded cannulated Set Screw on Nail insertion and/or removal of the Wire. A Reduction Spoon (151.0006) is available to facilitate the introduction of the Guide Wire for Opening Reamer (Ball Tip Guide Wire) past the fracture site and into the distal fragments.

Flexible reamers are not provided with the Hansson DC Nail System. The surgeon should therefore ensure that the flexible reamers used are suitable for the Guide Wire for Opening Reamer (Ball Tip Guide Wire). The Guide Wire has a shaft diameter of 3 mm and a spherical 4 mm ball tip.

Incrementally ream the femur up to a diameter 2 mm larger than the distal diameter of the Nail i.e. 13 mm for the 11 mm Short Nail and Long Nails, 11.5 mm for the 10 mm SL Nail (tapers to 9.5 mm distal to the distal locking hole). Image intensification should be used for guidance during these steps.

If the patient has a narrow intramedullary canal in the subtrochanteric region, it is possible to ream the proximal part of the intramedullary canal with a 16 mm flexible intramedullary reamer.

Note: Do not use the Threaded Guide Wire in combination with flexible intramedullary reamers.

Targeting Device Assembly

Selection of Nail

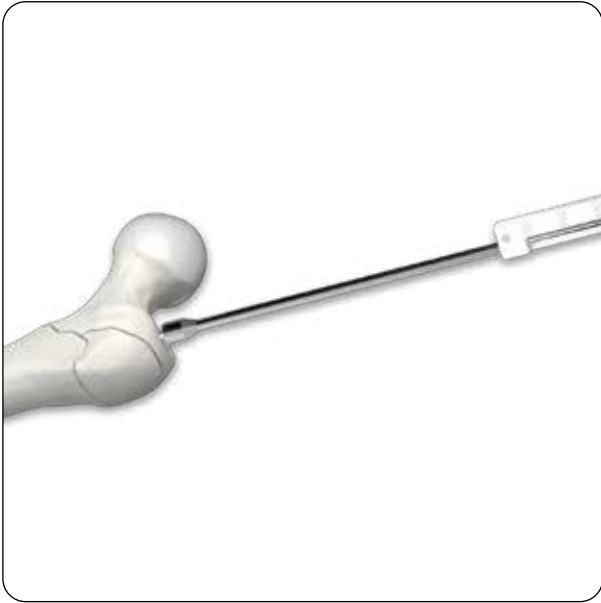

If a Short Nail (180 mm) is chosen measuring is not necessary. If an SL or Long Nail will be chosen, the required Nail length is defined by sliding the Measuring Sleeve for Long Nail (151.7001) over the Guide Wire for Opening Reamer (Ball Tip Guide Wire) until it stops at the tip of the greater trochanter. If between two Nails sizes, the shorter Nail length should always be selected.

Note: If an SL Nail will be chosen, the most appropriate length is the same length as if a Long Nail is to be used.

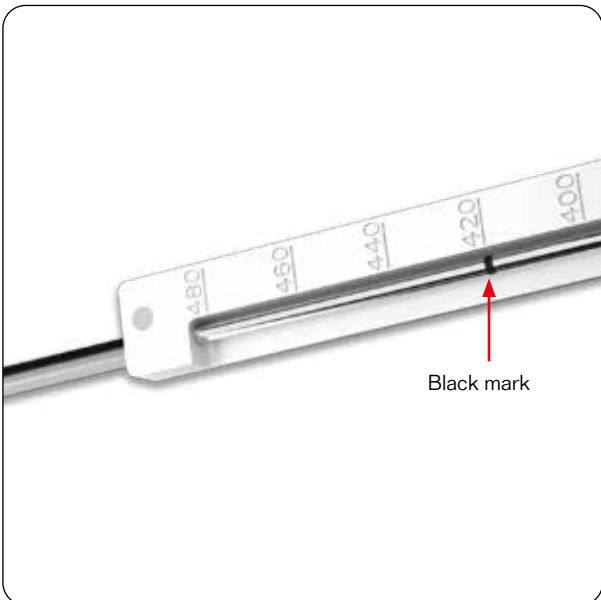

The black mark on the Guide Wire indicates where to read the length off the Measuring Sleeve.

Targeting Device assembly



The Targeting Device consists of three components which must be assembled before use: (1) the Targeting Device Arm (151.4002), (2) the Targeting Device Knob (151.4003), and (3) a Targeting Device Sleeve to match the CCD angle of the chosen Nail.

At market introduction, all Nail types are only available with a CCD angle of 125° and should be used with the Blue coloured Targeting Device Sleeve 125° (151.4005).



The Targeting Device Knob is mounted onto the base of the Targeting Device Arm by aligning the black arrow on the Knob with the white arrow on the inner side of the Arm. The parts are pushed together and a clicking sound confirms that the Knob is properly seated and able to rotate.



The correct Targeting Device Sleeve is then selected and inserted into the base of the Targeting Device. Align the pins of the Sleeve with the notches in the Knob and push forward to click the Sleeve into place. The Targeting Device Assembly is now ready for the selected Nail to be attached.

Note: It is only possible to insert the Sleeve in one direction to ensure the oblique holes will align.



The selected Nail is mounted on to the Targeting Device (it will only fit one way) and the Holding Bolt for Nail (151.4007) is inserted into the proximal opening. The Holding Bolt for Nail is then firmly tightened using the Ball Tip Screwdriver (151.1001) so that it does not loosen during the procedure.

Prior to Nail insertion it is important to check that the guide sleeves are aligned with the Targeting Device.

Check the Targeting Device



To check the proximal Hansson Twin Hook hole, the Drill Sleeve Biaxial for Proximal Hole (151.2006) is inserted into the Guide Sleeve-Biaxial (151.2005) which is then inserted into the Targeting Device (The Guide Sleeve-Standard (151.2003) can be chosen as an alternative). The Guide Sleeve is locked in position by turning the Knob clockwise until resistance is felt. The Cannulated Drill for Twin Hook (155.3001) is then inserted through the Drill Sleeve/Guide Sleeve assembly and through the hole in the Nail. The Drill should pass through the hole without obstruction. The Guide Sleeve is removed after turning the Knob anti-clockwise to release it.



To check the distal locking hole of a short or SL Nail, the Drill Sleeve for Locking Screw (151.2009) is inserted into the Guide Sleeve for Locking Screw (151.2008) which is then inserted into the Targeting Device. The Guide Sleeve assembly is locked in position by turning the Knob clockwise. The Drill for Locking Screw, Long (151.3007) is then inserted through the Guide Sleeve/Drill Sleeve assembly and through the hole in the Nail. The Drill should pass through the hole without obstruction. The Guide Sleeve is removed after turning the Knob anti-clockwise to release it.

Nail Insertion

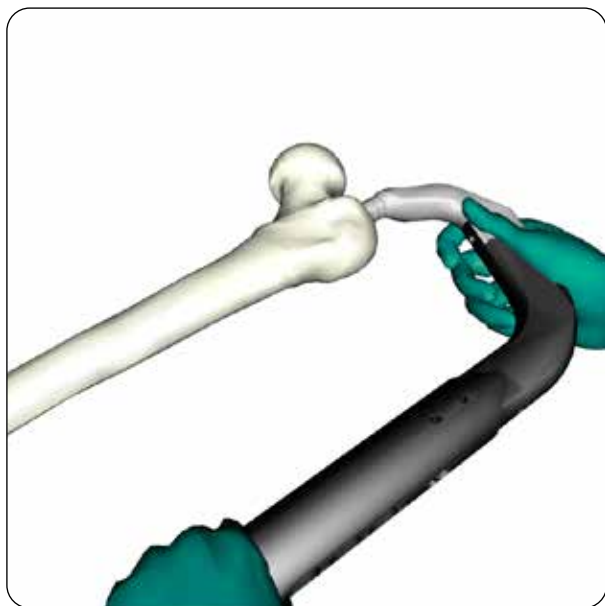

The Nail is inserted through the entry point and past the fracture into the intramedullary canal by hand. The Nail should advance without excessive force so if resistance is encountered, further reaming may be required.

Note: Do not insert the Nail over a Threaded Guide Wire. The Nail can only be introduced over the Guide Wire for Opening Reamer (Ball Tip Guide Wire) provided with the system so that the pre-loaded Set Screw is not disrupted.

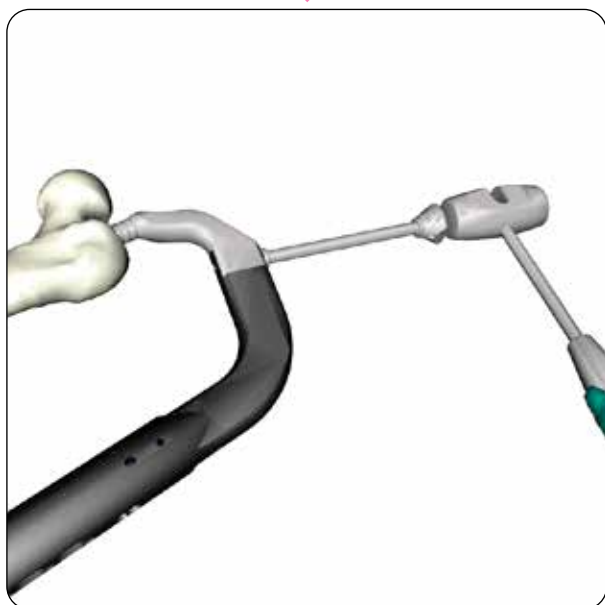

In cases where the bone is dense or where the surgeon may risk losing the reduction when rotating the Targeting Device/ Nail during insertion, the Strike Plate (151.5001) can be attached to the top of the Targeting Device to facilitate full insertion of the Nail. Ensure that the Strike Plate is fully threaded into the Targeting Device to avoid damage to the thread on impaction. The Hammer with Slot (151.5003) is used to gently tap the Strike Plate and insert the Nail to the correct depth.

Note: Do not strike the Targeting Device directly as it may cause damage. If the Strike Plate has been used, make sure that the Holding Bolt for Nail did not come loose.

Positioning Guide AP

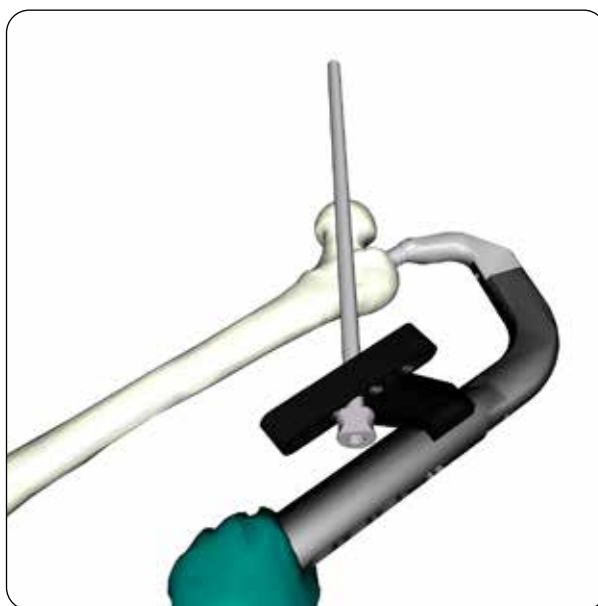

The Nail is inserted to a depth that ensures the Hansson Twin Hook will be aligned in an optimal position in the femoral head. In the AP view it should be in the centre of the femoral head or slightly inferior. In the lateral view it should be central.

To ensure an optimal position has been achieved in the AP view, the Positioning Guide AP (151.4008) is used together with the Positioning Guide AP-Tube (151.4009) to verify this.

With the C-arm still in AP position, the assembled Positioning Guide AP is attached to the Targeting Device by inserting its two pins into the dedicated holes on the Targeting Device.

The assembled Positioning Guide AP is now ready to indicate the position of the Hansson Twin Hook under image intensification.

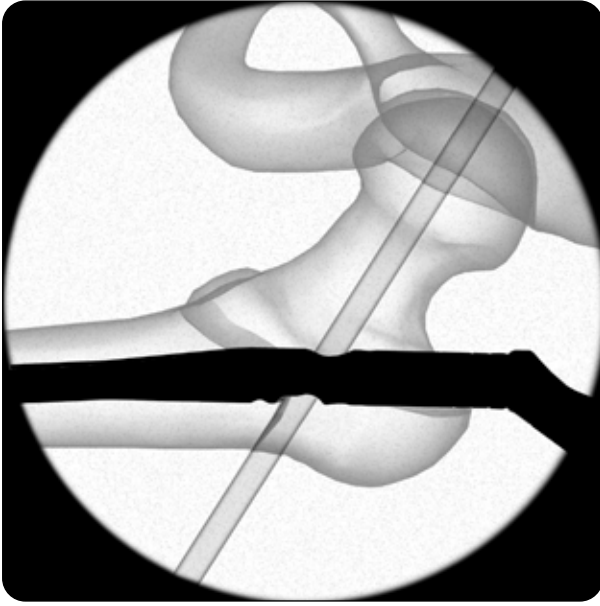

Ensure that the Positioning Guide AP - Tube is in line with the Hansson Twin Hook hole in the Nail by rotating the Targeting Device and adjust the position until the ideal placement for the Twin Hook in the AP view is achieved. Once the ideal position has been achieved, the depth of the Nail is maintained until the Threaded Guide Wire has been introduced and advanced to the subchondral bone of the femoral head (see Proximal Locking - Twin Hook section).

The Positioning Guide is designed for universal use in left and right applications (like the Targeting Device itself). Once the Nail is in the correct position, remove the Guide Wire for Opening Reamer.

Note: It is important to prevent the weight of the Targeting Device from externally rotating the Nail. The Targeting Device may be held by an assistant until the Threaded Guide Wire has been advanced to the subchondral bone in the femoral head.

PREPARATION
& INCISION

ENTRY POINT
& OPENING

TARGETING DEVICE
& INSERTION

PROXIMAL LOCKING
- TWIN HOOK

DISTAL LOCKING
- SHORT & SL NAIL

DISTAL LOCKING
- LONG NAIL

END CAP INSERTION

EXTRACTION

Proximal Locking

During preparation of the proximal locking (Hansson Twin Hook) hole, the Hansson DC Nail System provides the surgeon with the option of additionally preparing for Advanced Dynamisation along the axis of the femoral shaft.

In order for this function to be achieved, a notch is prepared in the lateral femoral cortex immediately below the Hansson Twin Hook. Dedicated instrumentation to perform this extra step is provided in the Hansson DC Nail System along with instrumentation for Proximal Locking without Advanced Dynamisation, if this is preferred.

Why Advanced Dynamisation along the axis of the femoral shaft in stable and unstable trochanteric fractures?

The standard technique for dynamisation along the axis of the femoral neck relies on the sliding effect between the nail and the Hansson Twin Hook. However, in most stable and unstable trochanteric fractures, dynamisation along the axis of the femoral neck is prevented because the proximal part of the Nail (at the entry point) and the fixation of the Hansson Twin Hook are both situated in the **red zone** impossible because the nail is blocking any potential sliding. Dynamisation along the axis of the femoral neck can only take place if there is a fracture situated in the **green zone**.

The standard technique for dynamisation along the axis of the femoral shaft is to use the distal locking hole in dynamic locking mode. However, this is only possible for fractures that are situated in the **blue zone** i.e. below the entry point of the Hansson Twin Hook. This is not possible if the fracture is situated above the entry point of the Hansson Twin Hook in the **red zone** because dynamisation of the distal fracture fragment is inhibited by the lateral cortex contacting the Hansson Twin Hook.

Using the standard techniques described above, dynamisation in the **red zone** is not possible. However, all the Nails in the Hansson DC Nail System have the capability of providing axial dynamisation along the axis of the femoral shaft by creating a notch immediately below the entry hole for the Hansson Twin Hook. This notch, created using dedicated instrumentation, prevents the distal fracture fragment from being inhibited by the lateral cortex of the distal fragment contacting the Hansson Twin Hook. This improved dynamic capability allows compression of fractures in the **red zone**.

Effective dynamisation permits load-sharing with continuous compression at the fracture site and may reduce the risk of fixation failure such as cut-out of the femoral head and non-union.

Please refer to:

- **Pages 18-21** for the surgical steps for **Proximal Locking with Advanced Dynamisation**
- **Page 22-25** for the surgical steps for **Proximal Locking without Advanced Dynamisation**
- **Pages 26-27** for the **Continuation of Proximal Locking**

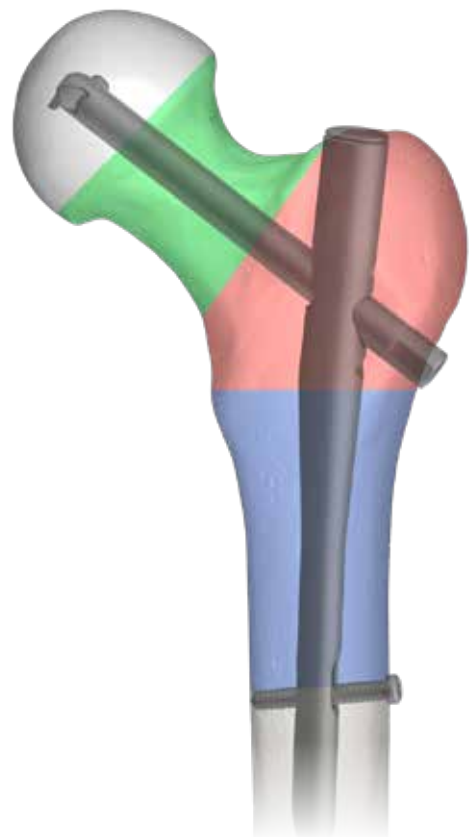

Creating the notch

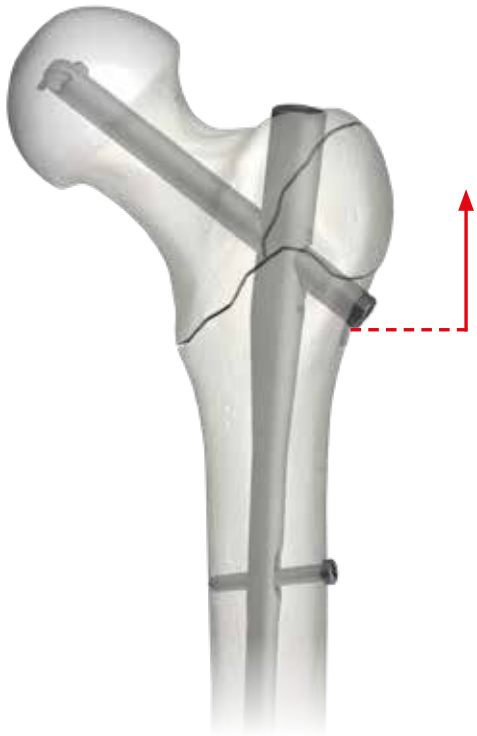

When is it necessary to create the notch to achieve Advanced Dynamisation?

If there is a fracture proximal to the Hansson Twin Hook entry point.

If the fracture line extends into the trochanteric region cranial to the entry hole of the Hansson Twin Hook, it is necessary to create the notch to prevent the lateral cortex of the distal fragment impinging on the Hansson Twin Hook and obstructing axial dynamisation along the axis of the femoral shaft. The distal locking screw must be inserted into the distal locking hole in dynamic mode.

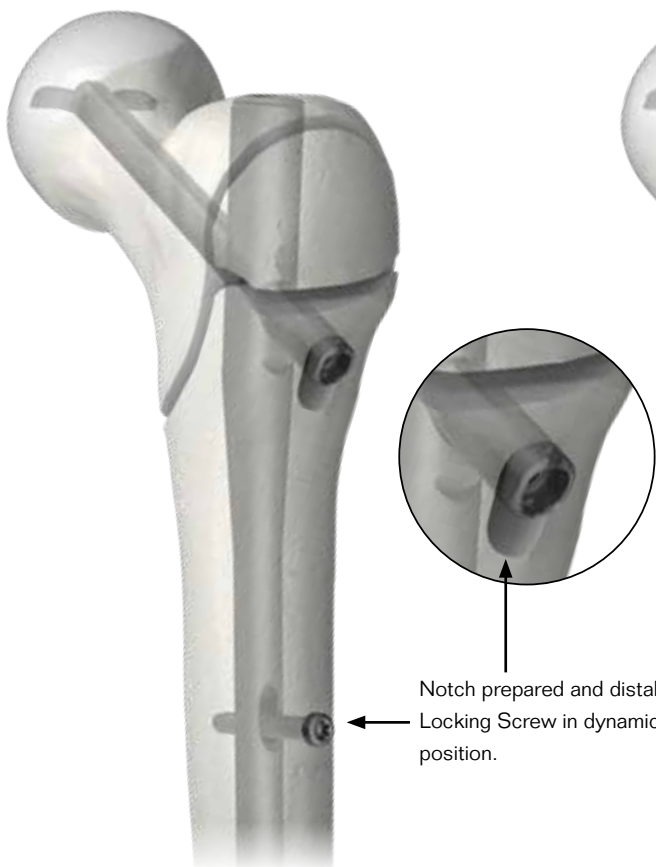

Notch prepared and distal Locking Screw in dynamic position.

Peri-operative:
Lateral cortex prepared with notch.



The distal Locking Screw and the distal fracture fragment (the femoral shaft) have dynamised along the axis of the femoral shaft.

Post-operative:
Dynamisation of the fracture has occurred after loading.

Proximal Locking with Advanced Dynamisation

Instruments for Hansson Twin Hook preparation



Guide Sleeve assembly



Guide Sleeve assembly

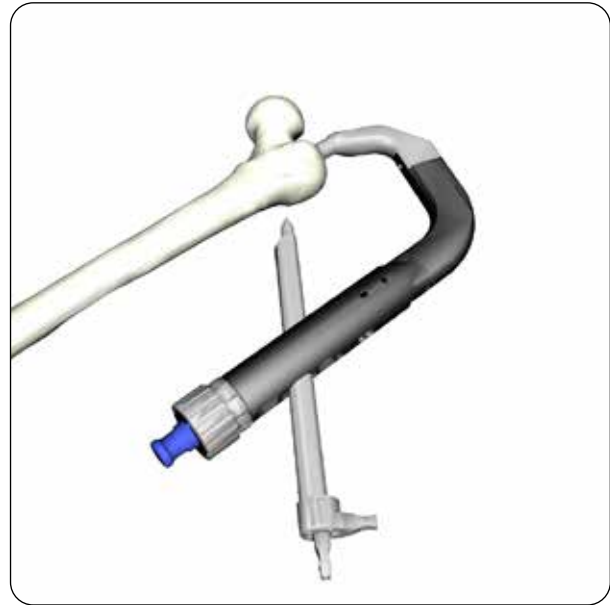

The Drill Sleeve Biaxial for Proximal Hole is inserted into the Guide Sleeve-Biaxial which is then inserted into the Targeting Device through the hole in line with the blue 125° markings. Ensure the arrows indicating CRANIAL are pointing in the right direction. The Threaded Guide Wire Sleeve is then inserted into the Drill Sleeve and the sleeve assembly is advanced to the skin. A skin incision is made down to the lateral cortex and the sleeve assembly is then advanced down to contact the bone.

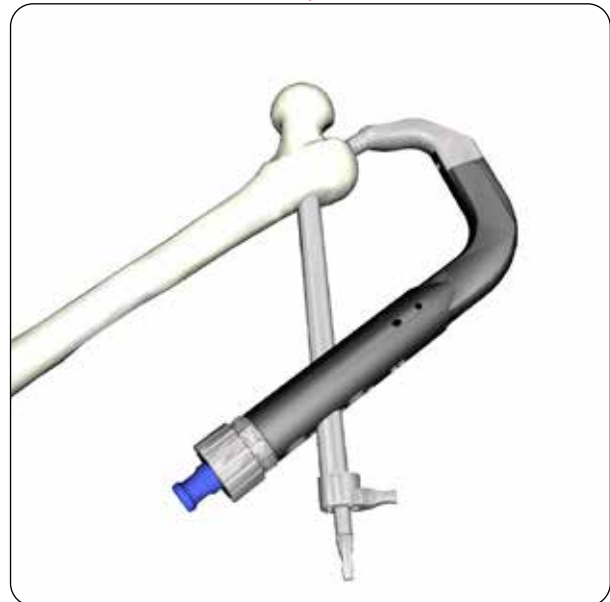

The Threaded Guide Wire Sleeve is longer than the Guide Sleeve and can be inserted so the tip is protruding from the Guide Sleeve and can act as a trocar during insertion. Slight rotation of the Threaded Guide Wire Sleeve can therefore help to facilitate the assembly to pass through the soft tissue. The final position is reached when the Guide Sleeve is in contact with the lateral cortex of the femur. Once this is achieved the Threaded Guide Wire Sleeve will protrude out of the back end of the Drill Sleeve (because it is longer). The position of the Guide Sleeve is verified with the image intensifier and then locked in position by tightening the Targeting Device-Knob.

Note: Retract the Guide Sleeve from the soft tissue if the depth of the Nail needs to be adjusted.

Guide Wire insertion

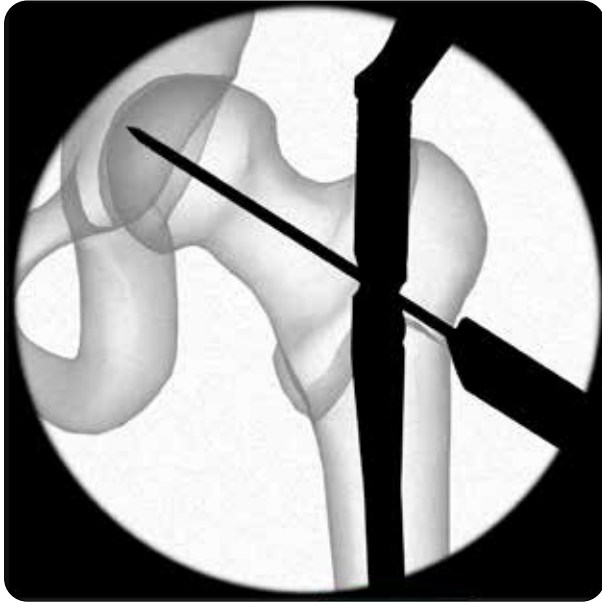

Ensure that the Guide Wire for Opening Reamer (Ball Tip Guide Wire) has been removed before inserting the Threaded Guide Wire for the Cannulated Drill for Twin Hook.

A Threaded Guide Wire Ø3.5 mm is inserted through the Threaded Guide Wire Sleeve and advanced to the subchondral bone of the femoral head.

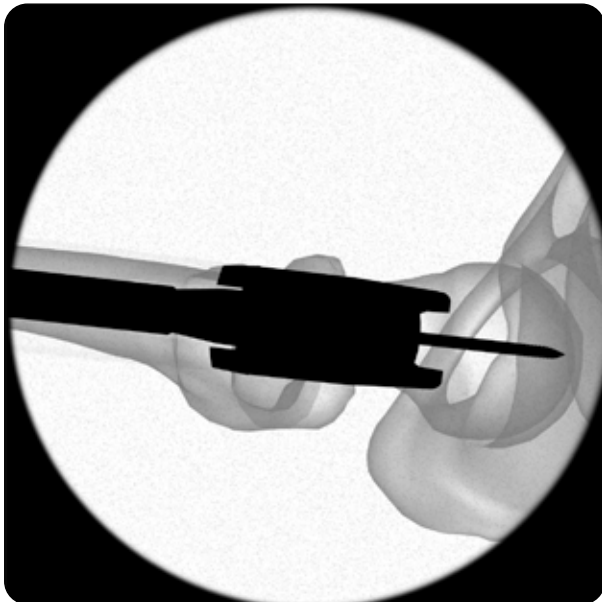

The image intensifier is used to verify the position of the Threaded Guide Wire in both planes and ensure there has been no deflection of the Wire which could cause issues when drilling. The Threaded Guide Wire must under no circumstances be accidentally advanced into the pelvis.

Note: A Threaded Guide Wire Ø3.2 mm (151.6003) is also provided for cases where a suitable wire driver for the Ø3.5 mm Guide Wire is not available. All Threaded Guide Wires are single use devices intended for one surgical procedure only and shall not be re-used.

Measuring



The Threaded Guide Wire is measured using the Measuring Guide (151.7002) which is placed against the end of the Drill Sleeve. The correct implant length and depth for reaming is 10 mm less than the reading on the Measuring Guide.

Note: Ensure the Guide Sleeve is still in contact with the bone for an accurate measurement.

Assemble the Cannulated Drill for Twin Hook

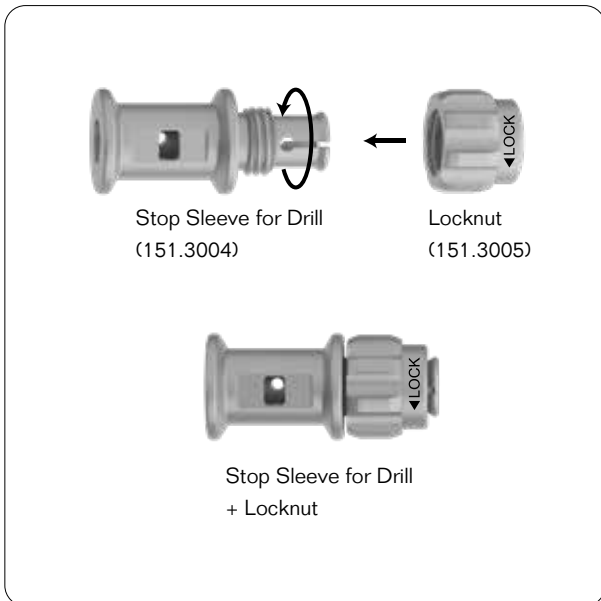

The Locknut is pushed forward on to the Stop Sleeve for Drill and turned clockwise as far as it will go. This is now ready to slide onto the back end of the Cannulated Drill for Twin Hook.

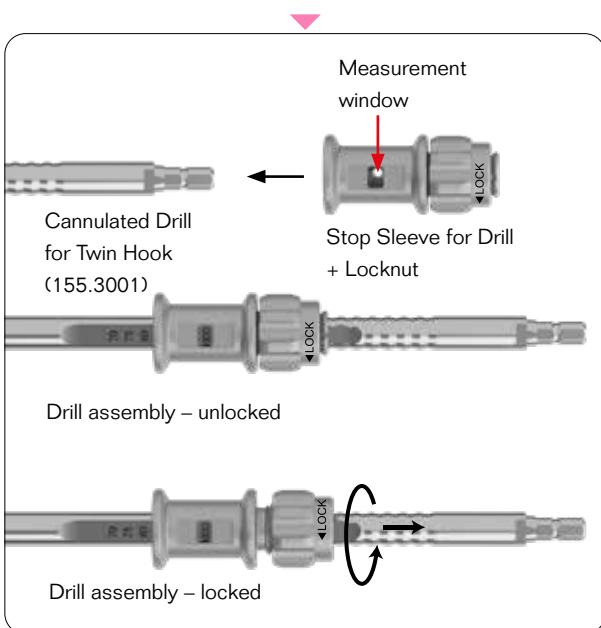

Slide the Stop Sleeve + Locknut along the Drill until the correct length is seen in the measurement window. Turn the Locknut anti-clockwise to lock the Stop Sleeve at the correct length for drilling.

Note: Always ensure that the Stop Sleeve has been firmly locked.

Drilling of the canal



Assemble the Cannulated Drill for Twin Hook and set it to the required depth. The Cannulated Drill for Twin Hook is then inserted over the Threaded Guide Wire and into the Drill Sleeve Biaxial for Proximal Hole. The drill is advanced until the Stop Sleeve contacts the Guide Sleeve. Attention is paid whilst drilling to ensure that deflection of the wire does not occur. If it does, the wire should be removed and replaced with a new one. Drilling depth is confirmed using image intensification.

Note: The Cannulated Drill for Twin Hook can be inserted by hand using the T-handle with Zimmer Hall Coupling or by power.

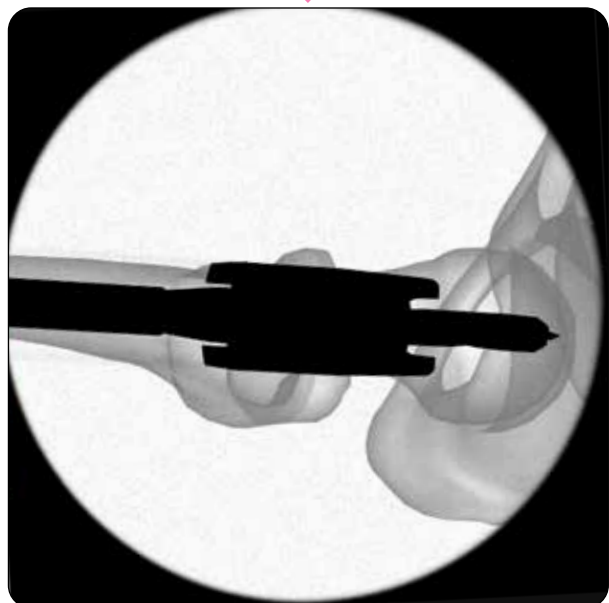

The Threaded Guide Wire must under no circumstances be accidentally advanced through the hip joint space into the pelvis. Ensure that the Guide Sleeve Biaxial is free from any bone debris after removing the Drill Sleeve Biaxial for Proximal Hole.

Instruments for Distal Notch preparation



Distal notch instrument assembly



Preparation of distal notch

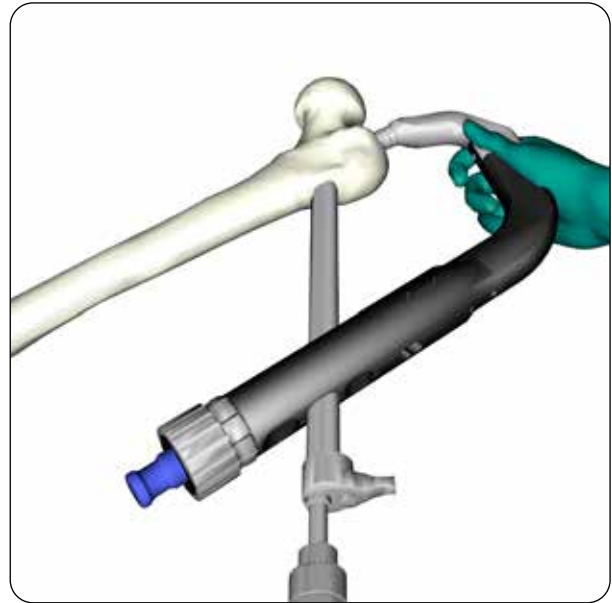

The Drill Sleeve Biaxial for Distal Notch (151.2007) is inserted into the Guide Sleeve.

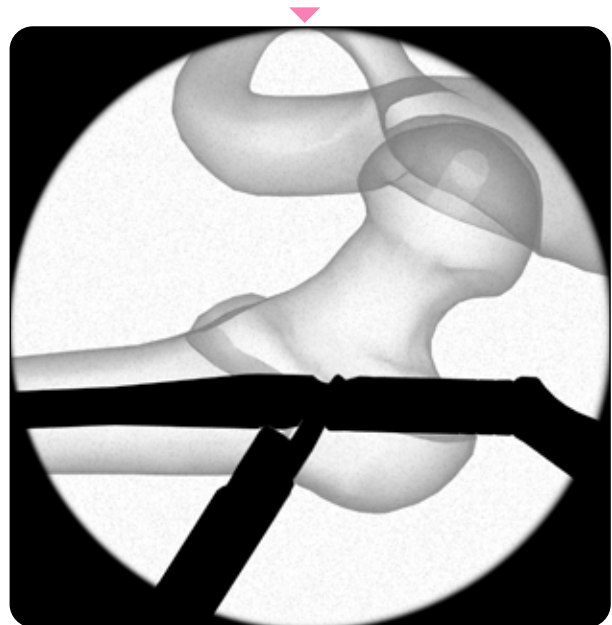

The Drill for Biaxial Dynamisation (151.3006) is then inserted into the Drill Sleeve Biaxial for Distal Notch and advanced until resistance is felt. The Drill Sleeve Biaxial for Distal Notch and the Drill for Biaxial Dynamisation are removed. The Guide Sleeve Biaxial is ready for the introduction of the Hansson Twin Hook.

Note: The Drill for Biaxial Dynamisation will not damage the Nail because it is flat at the tip and the Nail has a flat surface.

Proximal Locking without Advanced Dynamisation

Instruments for Hansson Twin Hook preparation

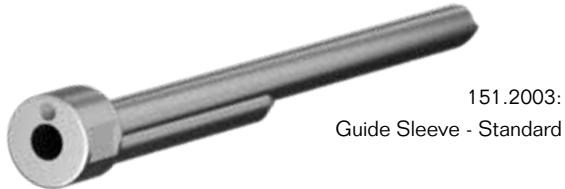

Guide Sleeve assembly



Guide Sleeve assembly

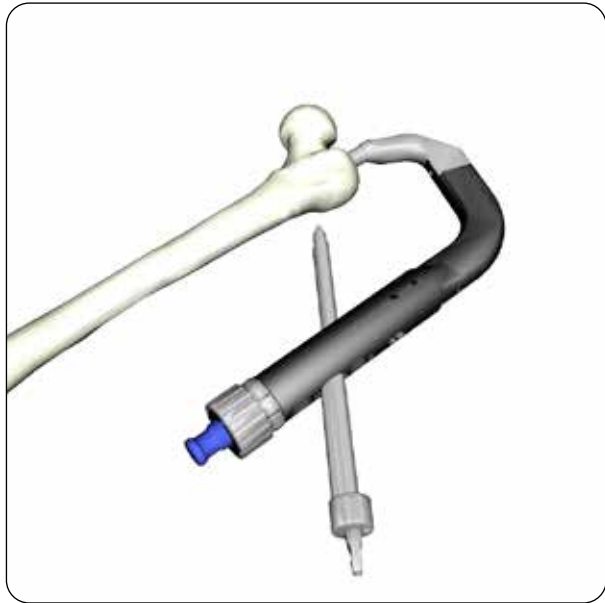

The Guide Sleeve-Standard is inserted into the Targeting Device through the hole in line with the blue 125° markings. Ensure the arrows indicating CRANIAL are pointing in the right direction. The Threaded Guide Wire Sleeve is then inserted into the Guide Sleeve and the assembly is advanced to the skin. A skin incision is made down to the lateral cortex and the sleeve assembly is then advanced down to the bone.

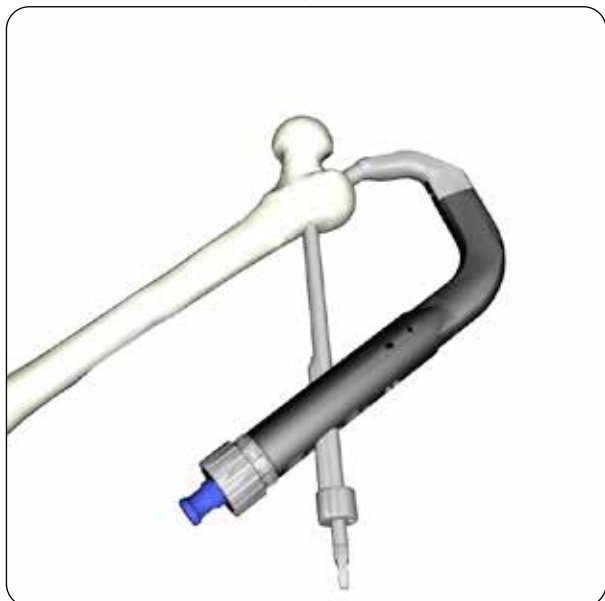

The Threaded Guide Wire Sleeve is longer than the Guide Sleeve and can be inserted so the tip is protruding from the Guide Sleeve and can act as a trocar during insertion. Slight rotation of the Threaded Guide Wire can therefore help to facilitate the assembly to pass through the soft tissue. The final position is reached when the Guide Sleeve is in contact with the lateral cortex of the femur. Once this is achieved the Threaded Guide Wire Sleeve will protrude out the back end of the Guide Sleeve (because it is longer). The position of the Guide Sleeve is verified with image intensification and then locked in position by tightening the Targeting Device-Knob.

Note: Retract the Guide Sleeve from the soft tissue if the depth of the Nail needs to be adjusted.

Guide Wire insertion

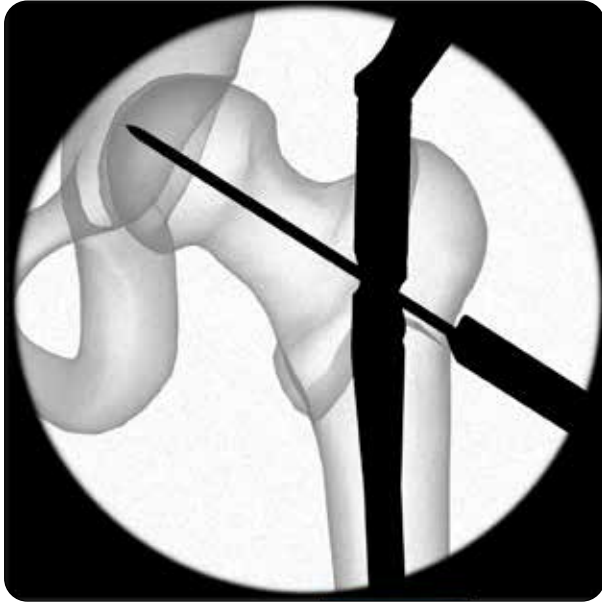

Ensure that the Guide Wire for Opening Reamer (Ball Tip Guide Wire) has been removed before inserting the Threaded Guide Wire for the Cannulated Drill for Twin Hook.

A Threaded Guide Wire $\text{\O}3.5$ mm is inserted through the Threaded Guide Wire Sleeve and advanced to the subchondral bone of the femoral head.

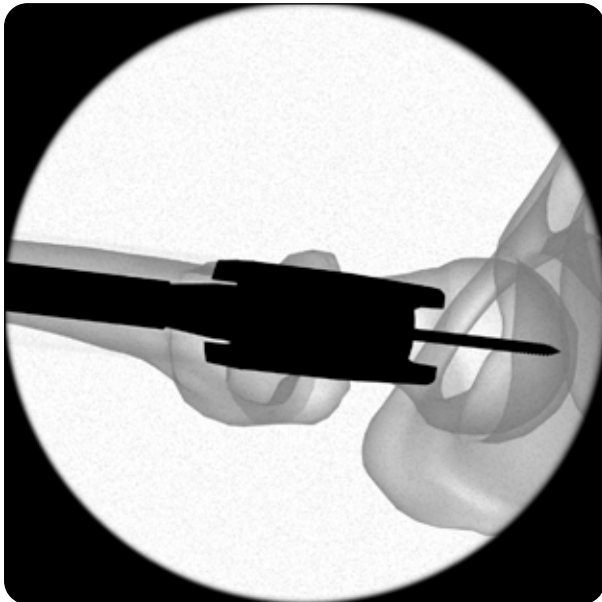

The image intensifier is used to verify the position of the Threaded Guide Wire in both planes and ensure there has been no deflection of the Wire which could cause issues when drilling. The Threaded Guide Wire must under no circumstances be accidentally advanced into the pelvis.

Note: A Threaded Guide Wire $\text{\O}3.2$ mm (151.6003) is also provided for cases where a suitable wire driver for the $\text{\O}3.5$ mm Guide Wire is not available. All Threaded Guide Wires are single use devices intended for one surgical procedure only and shall not be re-used.

Guide Wire measuring



The Threaded Guide Wire is measured using the Measuring Guide (151.7002) which is placed against the end of the Drill Sleeve. The correct implant length and depth for reaming is 10 mm less than the reading on the Measuring Guide.

Note: Ensure the Guide Sleeve is still in contact with the bone for an accurate measurement.

PREPARATION
& INCISION

ENTRY POINT
& OPENING

TARGETING DEVICE
& INSERTION

PROXIMAL LOCKING
– TWIN HOOK

DISTAL LOCKING
– SHORT & SL NAIL

DISTAL LOCKING
– LONG NAIL

END CAP INSERTION

EXTRACTION

Assemble the Cannulated Drill for Twin Hook

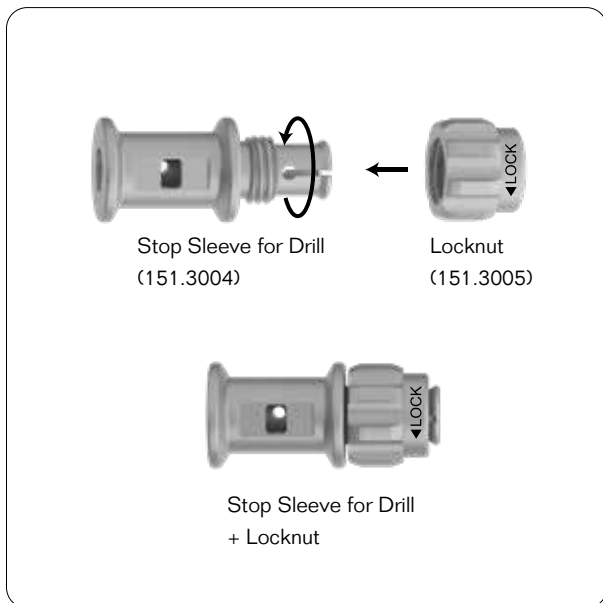

The Locknut is pushed forward on to the Stop Sleeve for Drill and turned clockwise as far as it will go. This is now ready to slide onto the back end of the Cannulated Drill for Twin Hook.

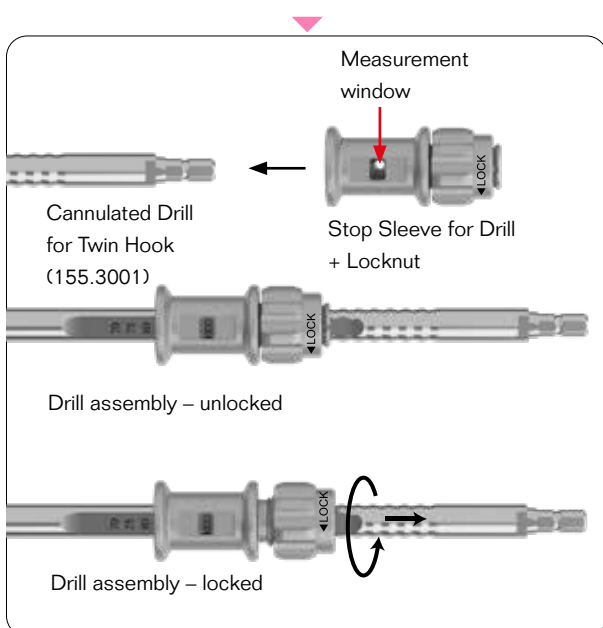

Slide the Stop Sleeve + Locknut along the Drill until the correct length is seen in the measurement window. Turn the Locknut anti-clockwise to lock the Stop Sleeve at the correct length for drilling.

Note: Always ensure that the Stop Sleeve has been firmly locked.

Drilling of the canal



Assemble the Cannulated Drill for Twin Hook and set it to the required depth. The Cannulated Drill for Twin Hook is then inserted over the Threaded Guide Wire and into the Guide Sleeve-Standard. The drill is advanced until the Stop Sleeve contacts the Guide Sleeve. Attention is paid whilst drilling to ensure that deflection of the wire does not occur. If it does, the wire should be removed and replaced with a new one. Drilling depth is confirmed using image intensification.

Note: The Cannulated Drill for Twin Hook can be inserted by hand using the T-handle with Zimmer Hall Coupling or by power.

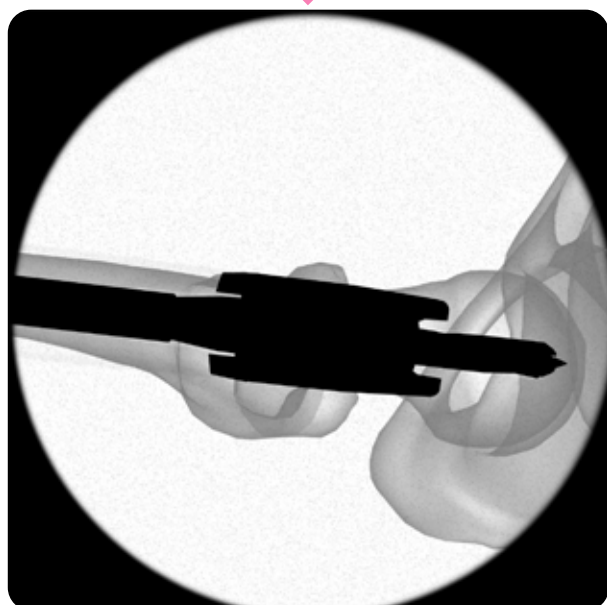

The Threaded Guide Wire must under no circumstances be accidentally advanced through the hip joint space into the pelvis.

EXTRACTION

END CAP INSERTION

DISTAL LOCKING
– LONG NAIL

DISTAL LOCKING
– SHORT & SL NAIL

PROXIMAL LOCKING
– TWIN HOOK

TARGETING DEVICE
& INSERTION

ENTRY POINT
& OPENING

PREPARATION
& INCISION

Continuation of Proximal Locking

Preparation for Hansson Twin Hook insertion

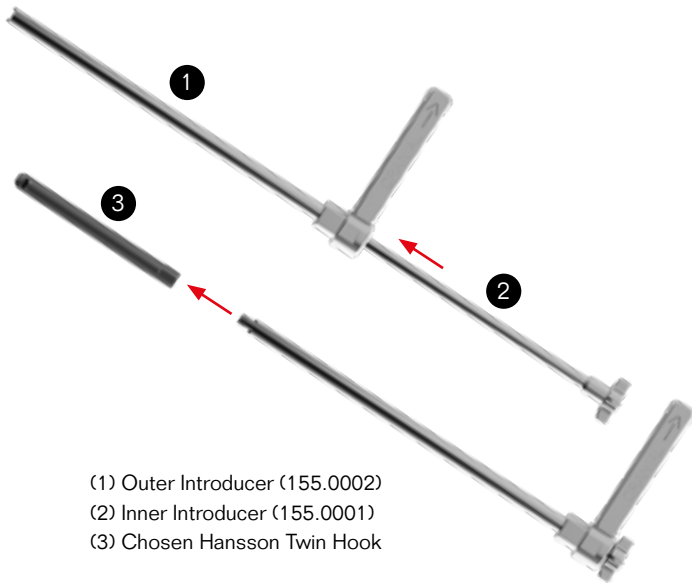

- (1) Outer Introducer (155.0002)
- (2) Inner Introducer (155.0001)
- (3) Chosen Hansson Twin Hook



The Inner Introducer is inserted into the Outer Introducer. The Inner Introducer is then firmly engaged into the base of the chosen Hansson Twin Hook. Start by engaging the threads of the Hansson Twin Hook and the Inner Introducer. Before the assembly is tightened, ensure that the Hansson Twin Hook and the Outer Introducer are correctly oriented; the smaller taper of the Outer Introducer shall be oriented with the smaller slot in the base of the Hansson Twin Hook.

Hansson Twin Hook insertion

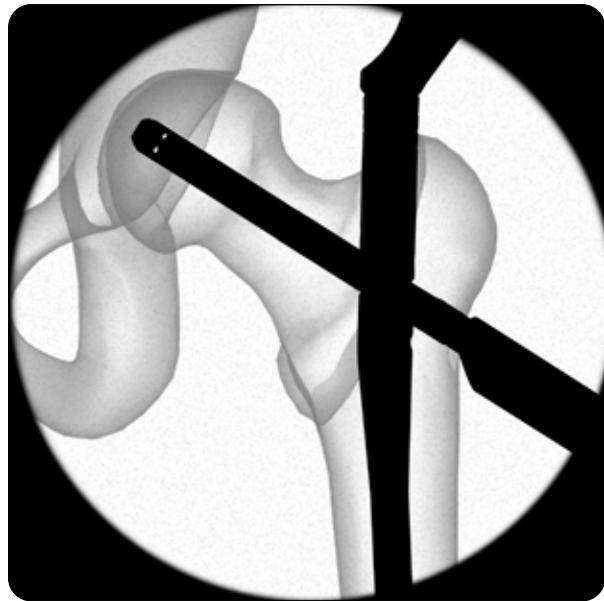

The Hansson Twin Hook is introduced through the Guide Sleeve Standard or Drill Sleeve Biaxial for Proximal Hole (depending on whether the Advanced Dynamisation method is being used or not) and pushed into the drilled canal. The final depth of the Hansson Twin Hook is reached when the Outer Introducer is in contact with the Sleeve.

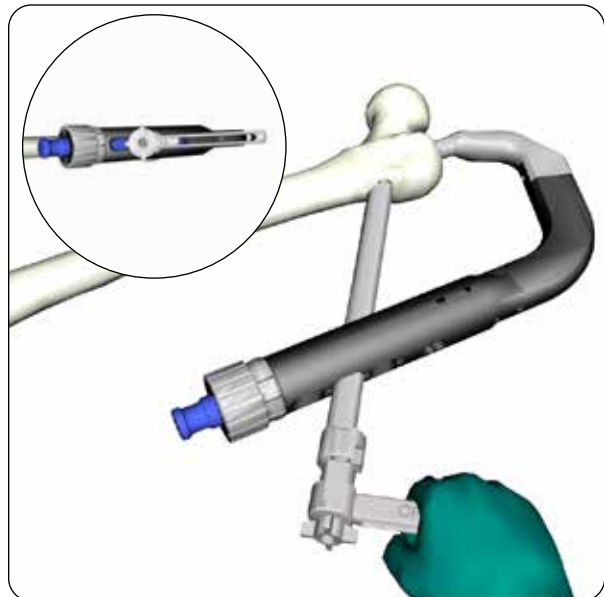

After full insertion, ensure that the handle of the Outer Introducer is aligned so it is parallel to the Targeting Device. The handle is marked with an arrow to indicate which way should be 'Cranial'. The correct alignment ensures that the groove on the Hansson Twin Hook is correctly positioned to accommodate the Set Screw which is preassembled in the proximal part of the Nail. The position of the Hansson Twin Hook is verified using image intensification.

Hansson Twin Hook fixation with Set Screw

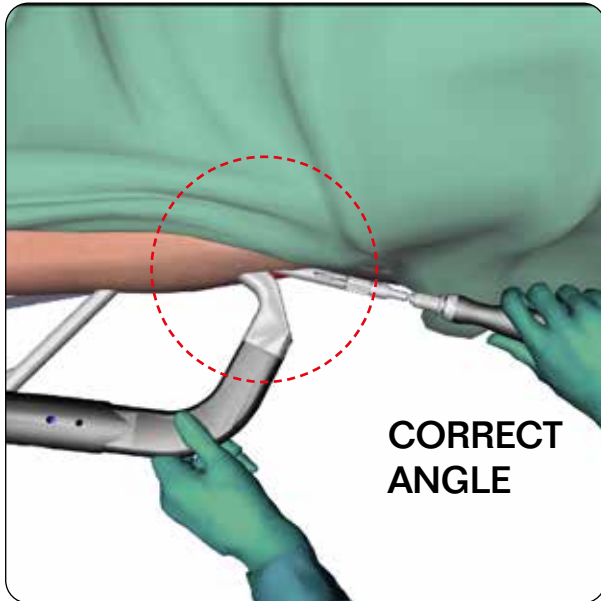

The Flexible Screwdriver (151.1004) is inserted into the Handle with AO Coupling (151.1007) and passed through the proximal opening in the Targeting Device and into the top of the Nail until the head of the Set Screw is located. The Flexible Screwdriver is turned clockwise to advance the Set Screw until contact with the Hansson Twin Hook is felt. The Set Screw is then unscrewed by no more than 1/8 of a turn (45°) so that it only just loses contact with the bottom of the Hansson Twin Hook groove. This will minimise rotational movements between the Hansson Twin Hook and the Nail while allowing free sliding of the Hansson Twin Hook. If the Set Screw is not positioned in the groove, the Hansson Twin Hook can rotate and migrate.

The correct position of the Set Screw in the groove of the Hansson Twin Hook should be verified by attempting to turn the handle of the Outer Introducer. It should not be possible to turn the handle.

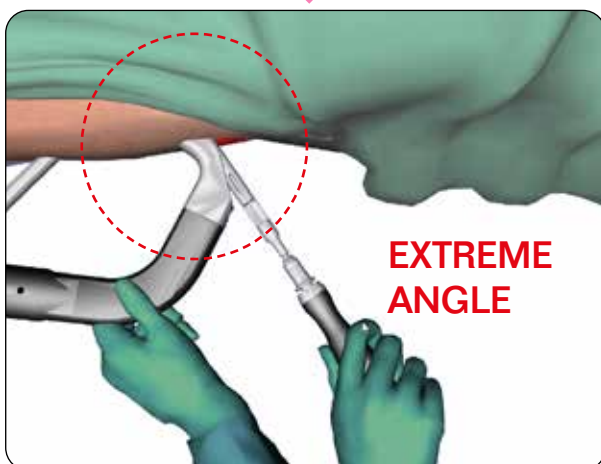

The Flexible Screwdriver will not function as intended if the flexible part is at an extreme angle.

Note: Attempting to remove the Flexible Screwdriver at an extreme angle can lead to screwdriver breakage.

Deploying the hooks

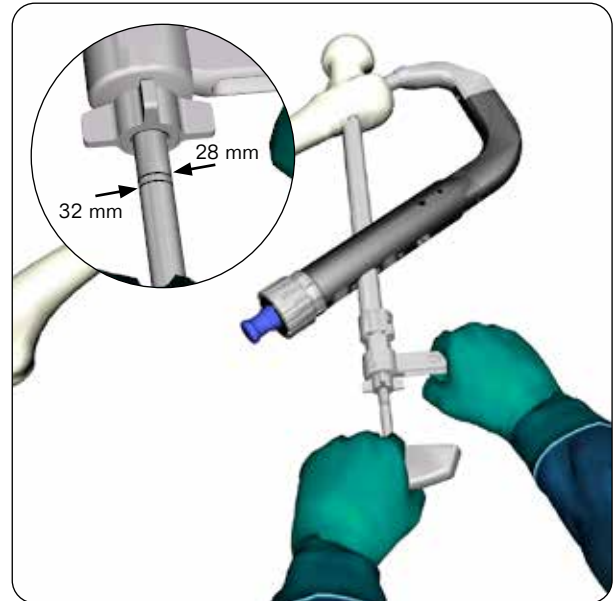

The Twin Hook Driver (155.1001) is inserted through the Inner Introducer until the Hansson Twin Hook is engaged. The Outer Introducer handle is then pushed forwards and the Twin Hook Driver is turned clockwise to start extruding the hooks. It is important to push forwards on the handle of the Outer Introducer when activating the hooks. This will increase the curvature of the hooks.

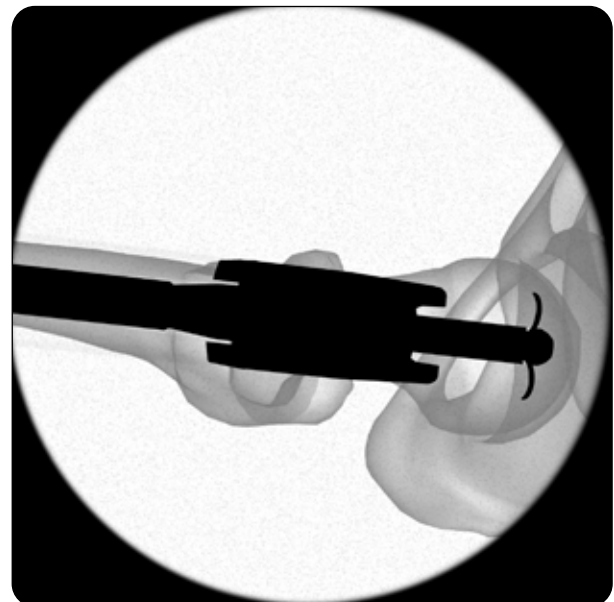

The hooks are fully deployed when the Twin Hook Driver reaches the mechanical stop and the black marking indicating 32 mm is at the edge of the Inner Introducer. The position of the hooks are then verified using image intensification. Once position is confirmed, the Twin Hook Driver is removed and the Inner Introducer is released from the Hansson Twin Hook by turning the Inner introducer anticlockwise. The introduction instruments, and the Sleeve are removed.

Note: If there is a risk of femoral head penetration it is possible to stop the extrusion of the hooks at 28 mm. There is an additional black marking on the Twin Hook Driver to indicate this. The hooks can also be retracted by turning the Twin Hook Driver anticlockwise.

Distal Locking – Short and SL Nail

Locking mode selection and instrument assembly

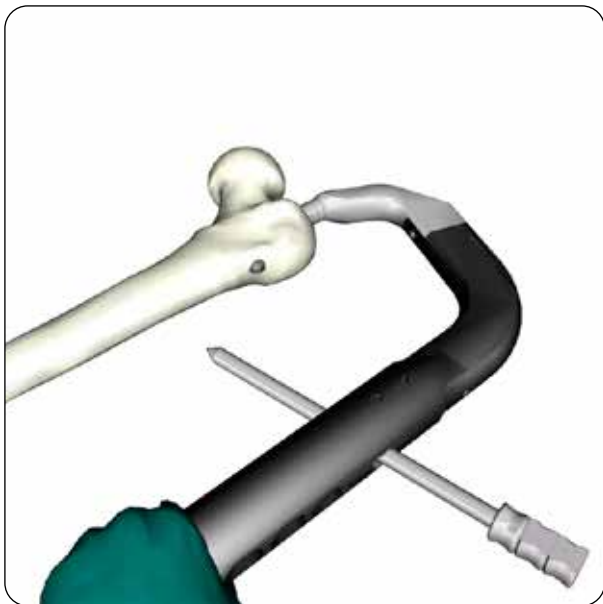

Dynamic or static locking mode is selected depending on surgeon preference and fracture suitability. There is a dedicated hole in the Targeting Device for each method.

If Advanced Dynamisation has been prepared for, dynamic locking mode is required.

The Trocar Tip for Locking Screw (151.2010) is inserted into the Drill Sleeve for Locking Screw (151.2009) which is then inserted into the Guide Sleeve for Locking Screw (151.2008). This assembly is then inserted into the chosen hole (static or dynamic) in the Targeting Device and advanced to the skin.

Incision and instrument introduction



A small skin incision is made from the tip of the Trocar down to the lateral cortex and the assembled Guide Sleeve for Locking Screw is inserted.

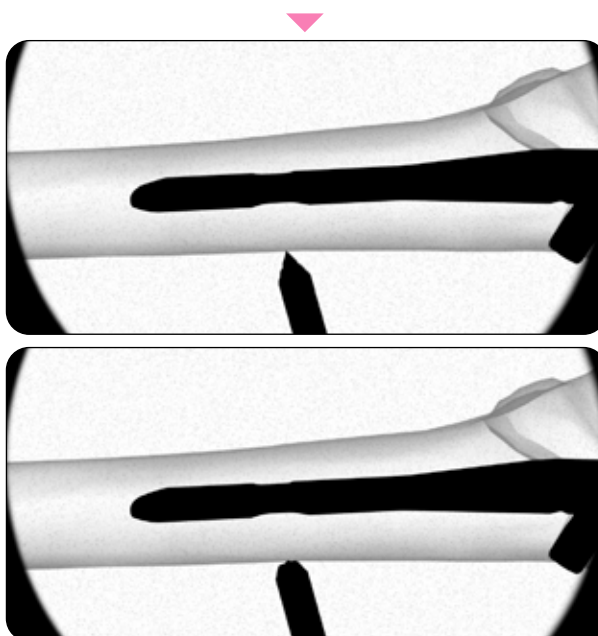

The assembly is advanced down to the bone until the Trocar Tip protrudes out of the Drill Sleeve indicating the Guide Sleeve is against the cortex. The Guide Sleeve is then fixed in position by locking the Targeting Device-Knob.

Drilling

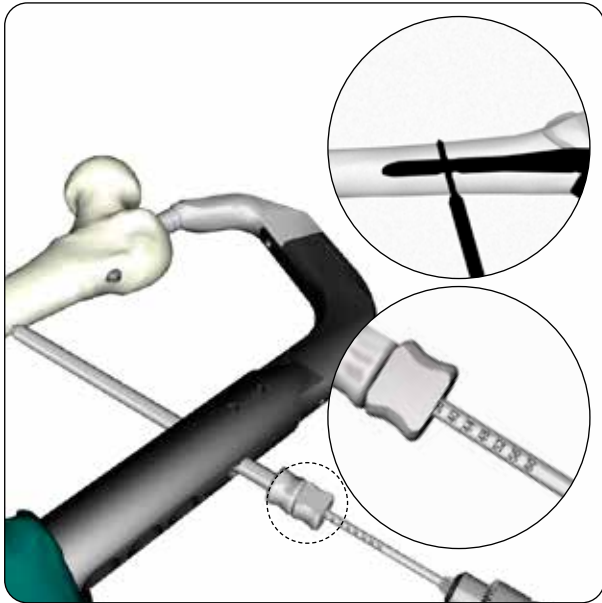

The Trocar Tip is removed and the Drill for Locking Screw, Long (151.3007) is inserted into the Drill Sleeve. The Drill for Locking Screw is advanced through the second cortex and the screw length is measured using the scale on the drill against the edge of the Drill Sleeve. The image intensifier is used for position verification.

An alternative method is to drill through the first cortex and then measure as the second cortex is reached. The screw length can be determined by reading the required screw length off the scale on the drill and adding the thickness of the second cortex to this measurement (approximately 5 mm).

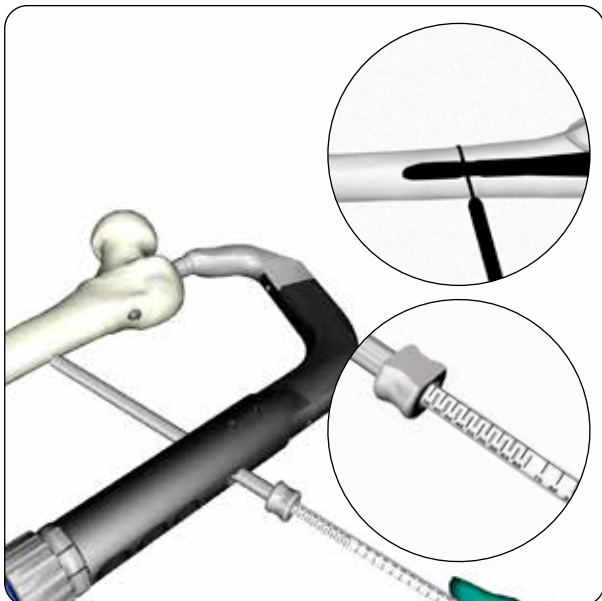

Another alternative method for measuring is to remove the Drill Sleeve and insert the white inner part of the Depth Gauge 8-125 mm (151.7004) into the Guide Sleeve. The screw length is determined by reading the required screw length off the scale on the inner Depth Gauge against the edge of the Guide Sleeve.

Note: If using the inner Depth Gauge to measure, do not adjust the Guide Sleeve position after drilling.

Screw insertion

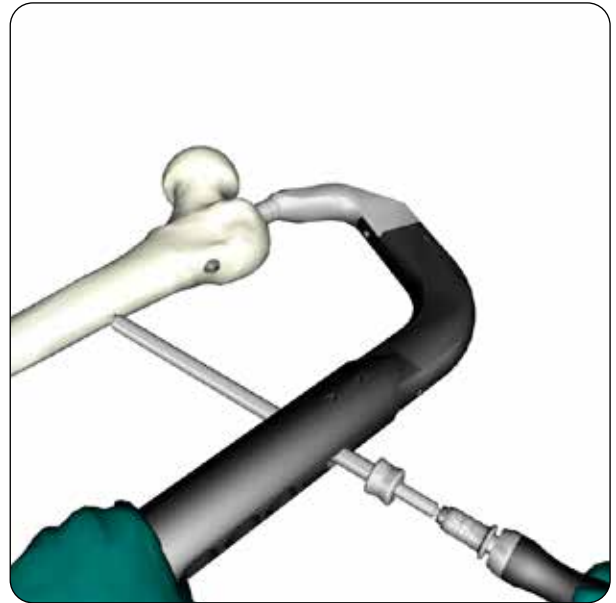

The Drill Sleeve is removed from the Guide Sleeve for Locking Screw which remains in place as a tissue protection sleeve for screw insertion.

The Screwdriver Bit (151.1005) is inserted into the Handle with AO Coupling and the selected Locking Screw Ø5 mm is seated on the Screwdriver tip.

The Locking Screw Ø5 mm is inserted through the Guide Sleeve and advanced to the desired depth by hand (do not use a power tool).

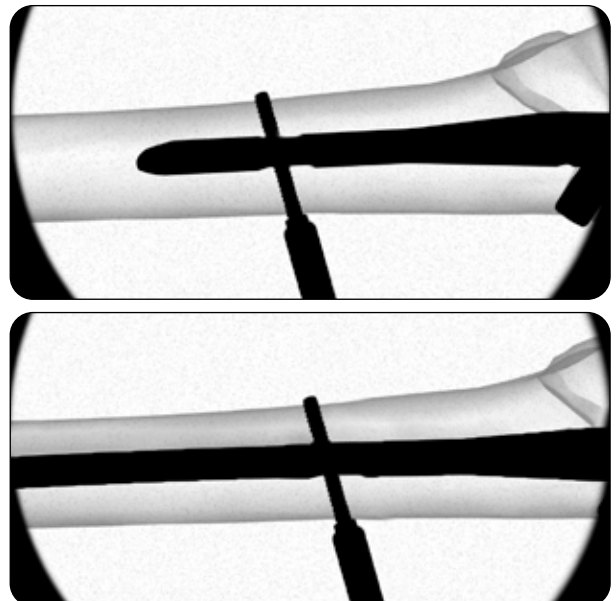

The two pictures above, shows the introduction of the Locking Screw in both the Short and the SL Nail.

Distal Locking – Long Nail

Distal Locking options

Distal locking of the Long Nail is performed using a freehand technique. The Granhed method (Ref. 1) is recommended. Each Nail has one round hole and one oblong hole which offers four different screw patterns.

Dynamic Locking

To create dynamic locking (Fig. A), one screw is placed distally in the oblong hole.



Fig. A

Secondary Dynamisation

To create secondary dynamisation (Fig. B), one screw is placed distally in the oblong hole and another screw is placed in the round proximal hole.

If dynamic compression is needed at a later stage, the proximal screw placed in the round hole has to be removed.



Fig. B

Static Locking

To create static locking (Fig. C), one screw is placed proximally in the oblong hole and another screw is placed in the round proximal hole. Alternatively just one screw is placed in the round proximal hole (Fig. D).



Fig. C



Fig. D

The following text describes how to place a locking bone screw using the dynamic locking mode according to fig. A. Before locking the Nail, it is very important to check length and alignment of the leg.

1. Granhed H. P. (1998).

A new technique of distal screw insertion for locked Nailing.

Acta orthopaedica Scandinavica, 69(3), 320–321.

Positioning of the image intensifier

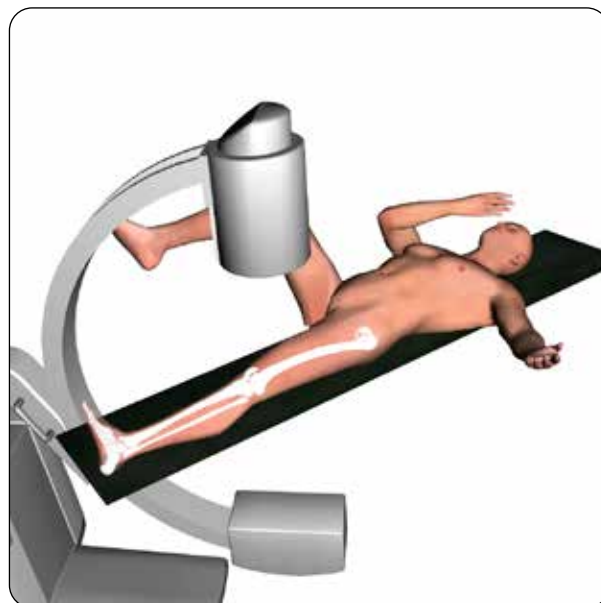

An image intensifier is centered over the distal holes of the Nail. In the AP view, the holes can be seen as two symmetric ovals. If two ovals cannot be seen, either the image intensifier or the leg is rotated.

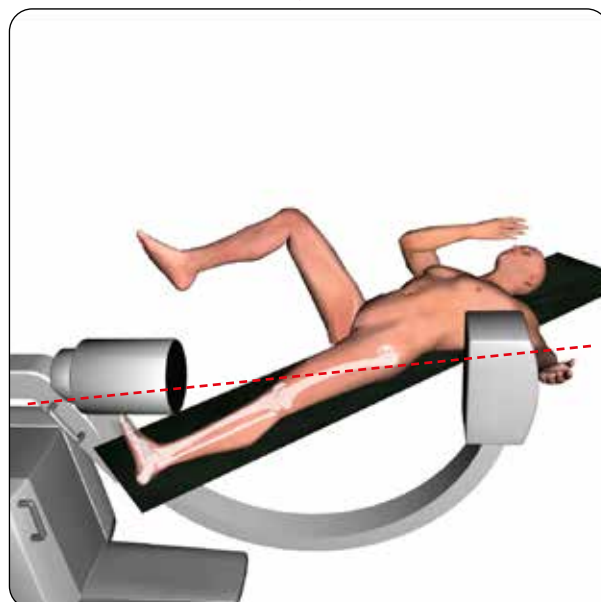

In the ML view, the image intensifier is positioned 20-45 degrees oblique to the femur.

Locate the optimal point for skin incision

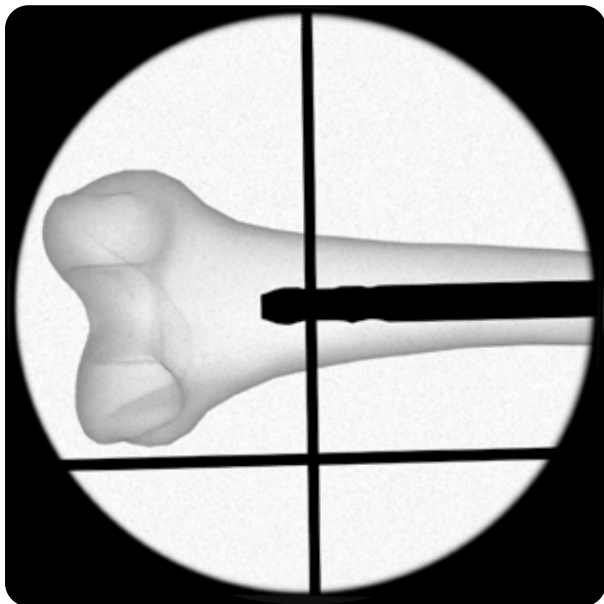

With an anterior guide wire positioned exactly over the most distal hole of the Nail, the correct spot for the lateral incision in one plane is determined. By looking at the ML view, the AP position for the screws can be selected. The incision should be made along the middle line of the Nail visualised on the screen.

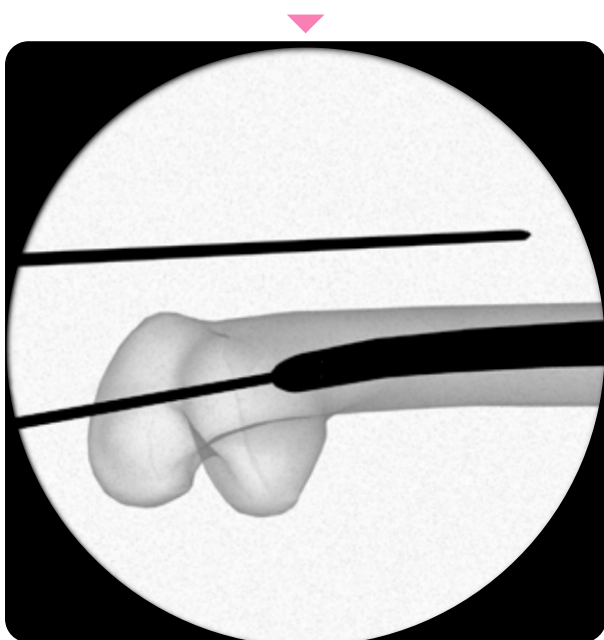

A skin incision is made in line with the distal hole of the Nail.

Align the drill in both AP and ML view

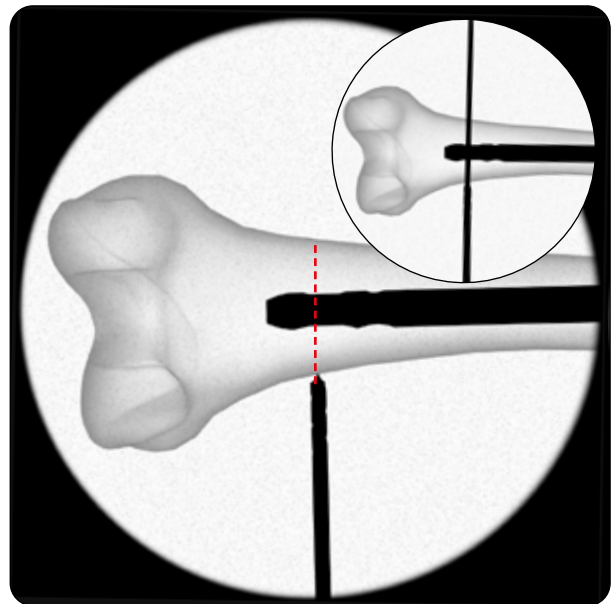

Introduce the Drill for Locking Screw, Short (151.3008) through the incision down to the cortex. The drill bit should be perpendicular to the Nail and in line with two of the opposite ovals, checked with an external guide wire in AP view or the Positioning Template. Without moving the drill bit change to the ML view.

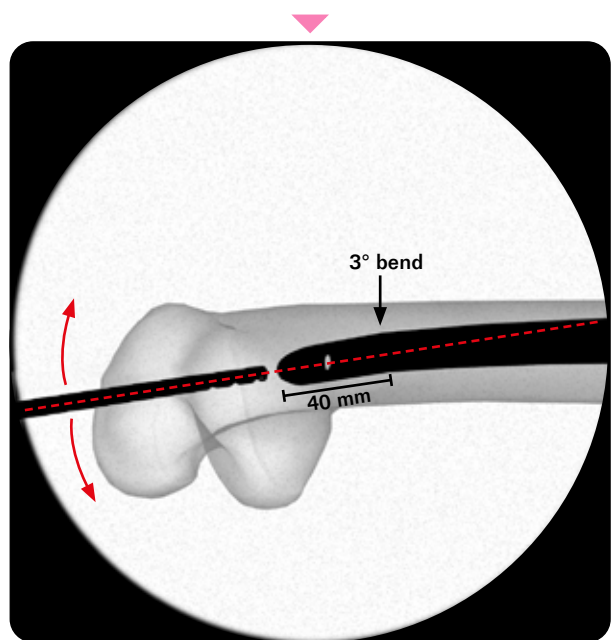

The screw holes are not visible in the ML view, but the drill should be positioned in the middle of the Nail and in line with the length axis of the last 40 mm of the Nail. The correct drilling position is achieved by a gentle movement of the drill anteriorly or posteriorly.

Drilling and measuring

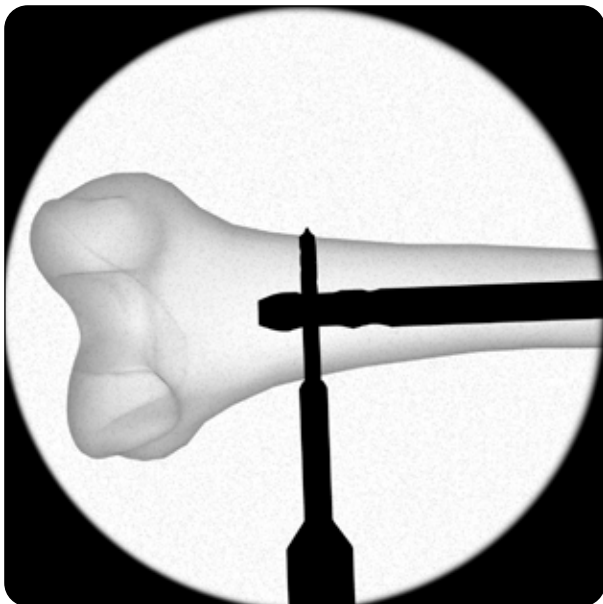

The drill is advanced through the second cortex and the screw length is measured from the black mark on the Drill against the scale on the Measuring Sleeve (151.7003). The image intensifier is used for clarification.

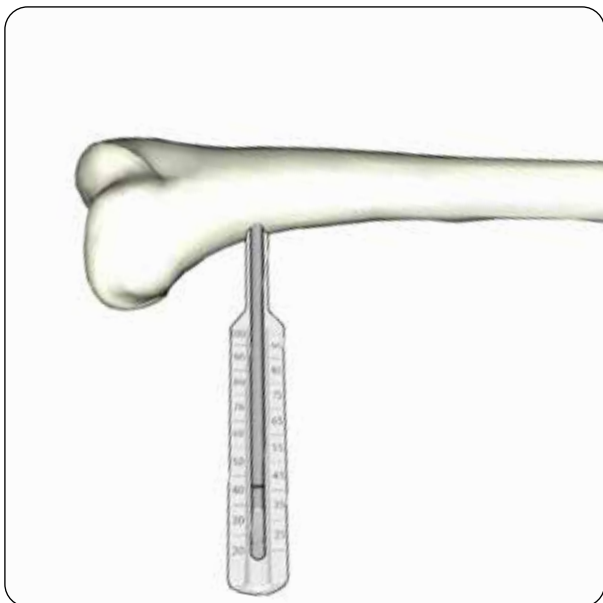

An alternative method is to drill through the first cortex and then measure as the second cortex is reached. The screw length can be determined by reading the length from the black mark on the Drill against the scale on the Measuring Sleeve and adding the thickness of the second cortex (approximately 5 mm).

The Depth Gauge 8-125 mm (151.7004) can also be used to measure the screw length. Remove the Drill and the Measuring Sleeve.

Screw insertion

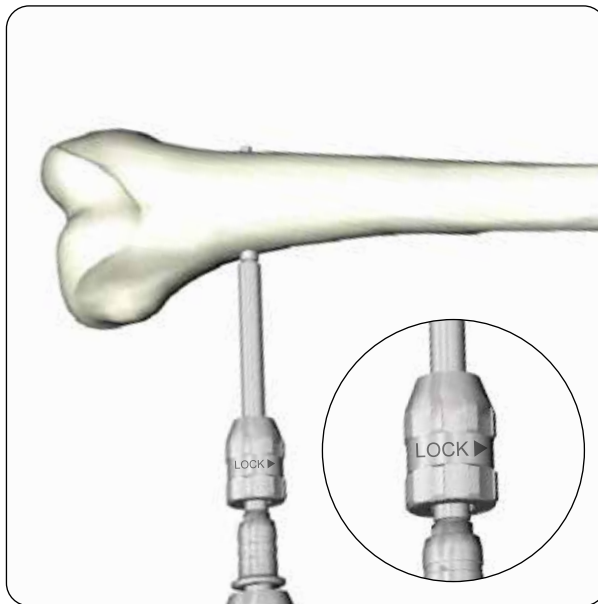

Insert the Self-Retaining Screwdriver (151.1006) into the Handle with AO Coupling and seat the chosen length Ø5 mm Locking Screw on to the driver tip. The screw is locked to the Self-Retaining Screwdriver by turning the lock wheel clock-wise which expands the driver tip into the head of the screw. Insert the screw and advance it until the screw head is in contact with the lateral cortex. To detach the Self-Retaining Screwdriver turn the wheel anti-clockwise.

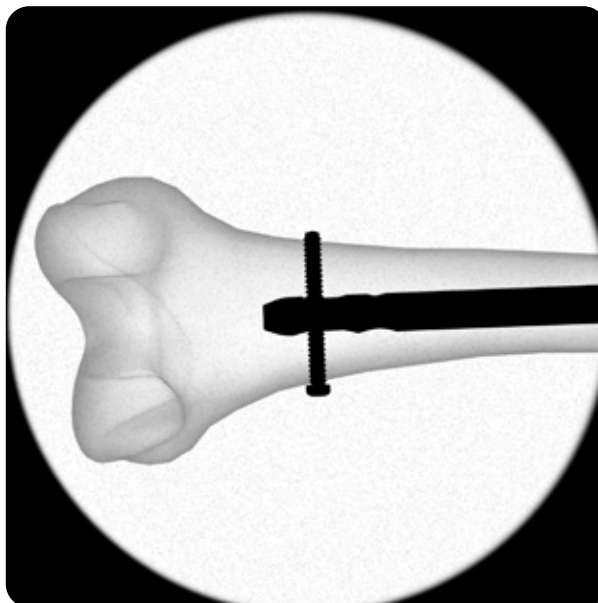

The image above shows the dynamic locking option with only one locking screw in the distal part of the oblong hole.

EXTRACTION

END CAP INSERTION

**DISTAL LOCKING
– LONG NAIL**

DISTAL LOCKING
– SHORT & SL NAIL

PROXIMAL LOCKING
– TWIN HOOK

TARGETING DEVICE
& INSERTION

ENTRY POINT
& OPENING

PREPARATION
& INCISION

End Cap Placement

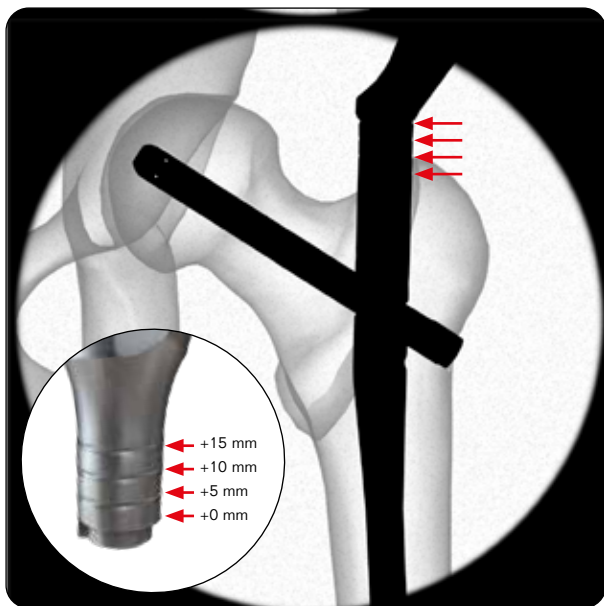

Select the appropriate End Cap. The post of the Targeting Device has circumferential grooves which correspond with the available End Caps of +0 mm, +5 mm, +10 mm, +15 mm. These grooves are visible under image intensification.

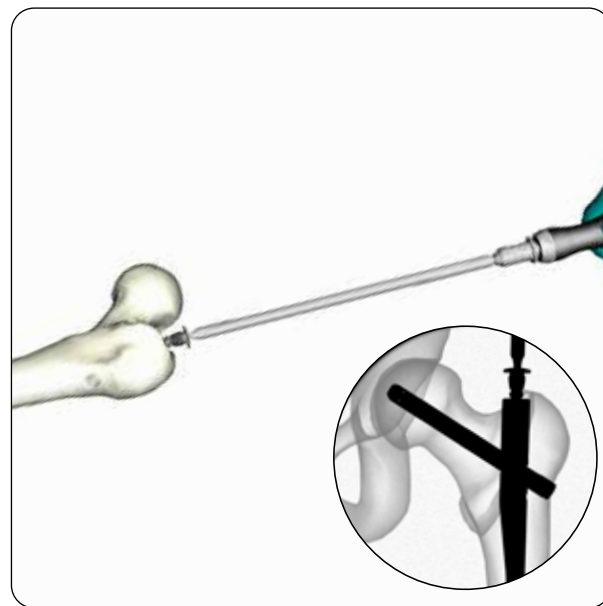

Insert the chosen End Cap using the Screwdriver Bit (151.1005) and the Handle with AO Coupling.



The Targeting Device is removed by unscrewing the Holding Bolt for Nail with the Ball Tip Screwdriver (151.1001).

Check implant position

After the procedure check the proper positioning of all implants using image intensification. Correct positioning of the implant parts is extremely important for the clinical outcome.

Extraction

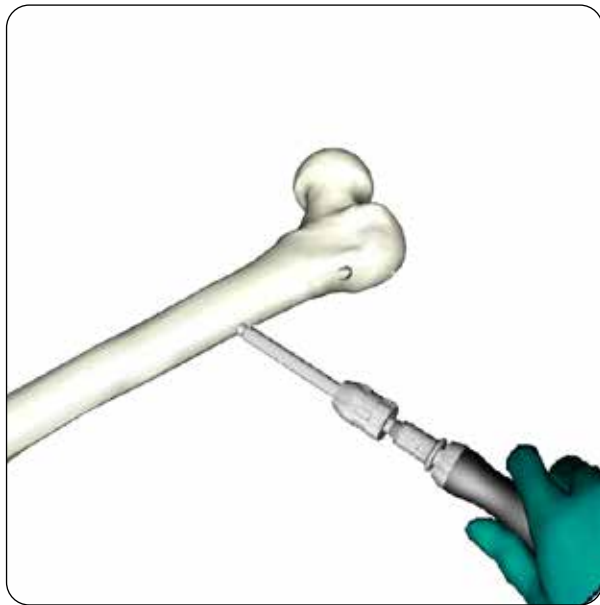

An incision is made through the scar where the distal Locking Screw was inserted. The Self-Retaining Screwdriver (151.1006) is attached to the Handle with AO Coupling and used to remove the Locking Screw.

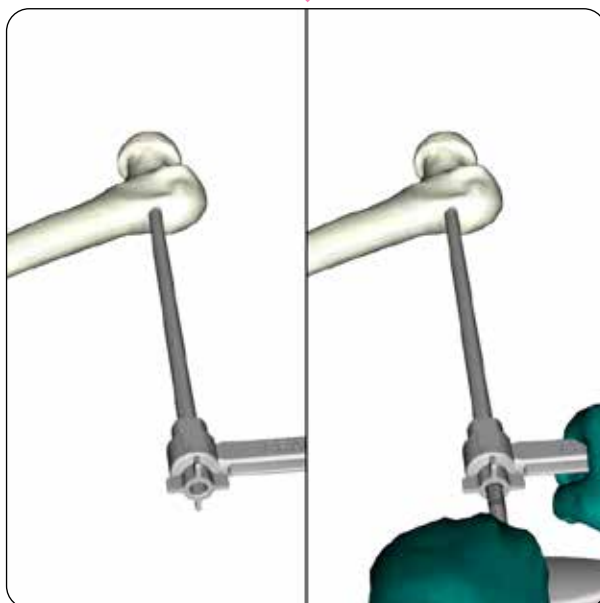

Another incision is made through the scar below the greater trochanter where the Hansson Twin Hook was introduced. The end of the Hansson Twin Hook is exposed and any attached soft tissue and/or bony ingrowths are carefully removed. The Inner Introducer is inserted into the Outer Introducer and the assembly is inserted into the Hansson Twin Hook by turning the Inner Introducer clockwise and aligning the tabs. The Twin Hook Driver is inserted into the Inner Introducer and turned anti-clockwise to withdraw the hooks into the outer pin. Do not remove the Hansson Twin Hook and the Introducer Assembly at this stage.

Note: Use image intensification to ensure that the hooks of the Hansson Twin Hook have been fully withdrawn.

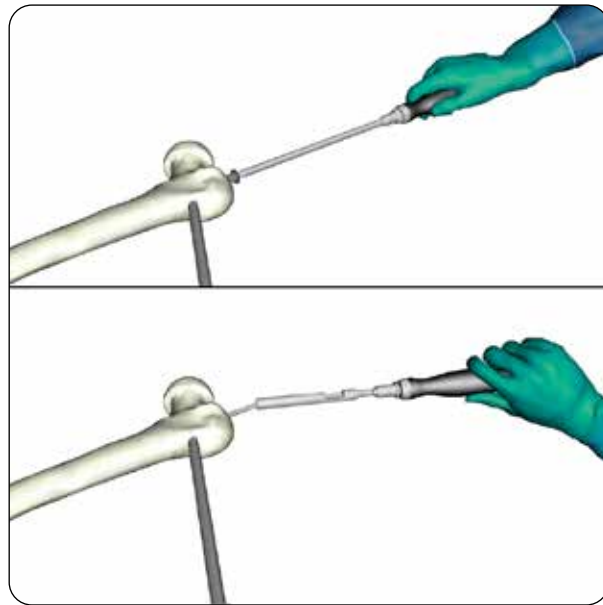

A third incision is made over the proximal end of the Nail and the End Cap is removed using the Screwdriver Bit mounted in the Handle with AO Coupling.

The Flexible Screwdriver is passed into the proximal part of the Nail to engage the Set Screw. The Set Screw is unscrewed 2 turns until it is disengaged from the Hansson Twin Hook.

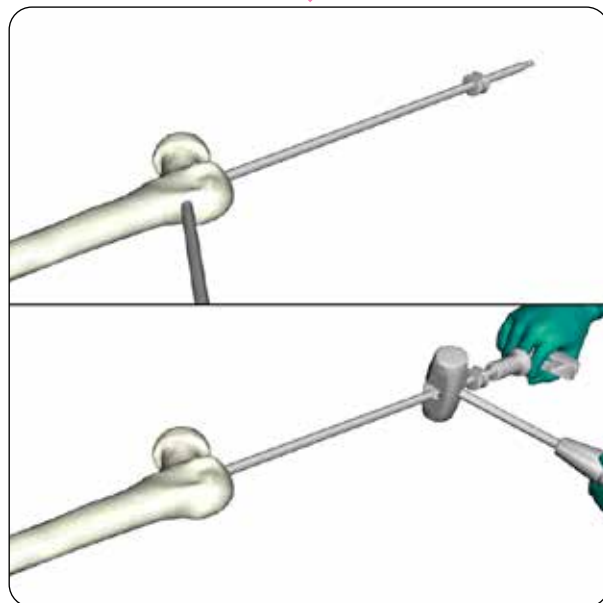

The T-Handle with Zimmer Hall Coupling (151.0004) is attached to the Extraction Rod (151.5002) and threaded into the Extraction Rod into the Nail. Only once the Extraction Rod is safely connected can the Hansson Twin Hook be removed. The Nail is then extracted using the Hammer with Slot.

Note: If the Hansson Twin Hook is removed before the Extraction Rod is threaded into the Nail, the Nail can be pushed distally into the intramedullary canal when attempting to attach the Extraction Rod. Subsequent extraction may be difficult.

PREPARATION
& INCISION

ENTRY POINT
& OPENING

TARGETING DEVICE
& INSERTION

PROXIMAL LOCKING
- TWIN HOOK

DISTAL LOCKING
- SHORT & SL NAIL

DISTAL LOCKING
- LONG NAIL

END CAP INSERTION

EXTRACTION

Product information

Implants

Short Nail

Hansson DC Nail - Short 180 mm, 125°, Ø11 mm	151.180.125.11.S
--	------------------

Superior Lock (SL) Nails

Hansson DC Nail - SL - Left 240 mm, 125°, Ø10 mm	151.SL.240.125.L.S
--	--------------------

Hansson DC Nail - SL - Left 260 mm, 125°, Ø10 mm	151.SL.260.125.L.S
--	--------------------

Hansson DC Nail - SL - Left 280 mm, 125°, Ø10 mm	151.SL.280.125.L.S
--	--------------------

Hansson DC Nail - SL - Left 300 mm, 125°, Ø10 mm	151.SL.300.125.L.S
--	--------------------

Hansson DC Nail - SL - Left 320 mm, 125°, Ø10 mm	151.SL.320.125.L.S
--	--------------------

Hansson DC Nail - SL - Left 340 mm, 125°, Ø10 mm	151.SL.340.125.L.S
--	--------------------

Hansson DC Nail - SL - Left 360 mm, 125°, Ø10 mm	151.SL.360.125.L.S
--	--------------------

Hansson DC Nail - SL - Left 380 mm, 125°, Ø10 mm	151.SL.380.125.L.S
--	--------------------

Hansson DC Nail - SL - Left 400 mm, 125°, Ø10 mm	151.SL.400.125.L.S
--	--------------------

Hansson DC Nail - SL - Left 420 mm, 125°, Ø10 mm	151.SL.420.125.L.S
--	--------------------

Hansson DC Nail - SL - Left 440 mm, 125°, Ø10 mm	151.SL.440.125.L.S
--	--------------------

Hansson DC Nail - SL - Left 460 mm, 125°, Ø10 mm	151.SL.460.125.L.S
--	--------------------

Hansson DC Nail - SL - Left 480 mm, 125°, Ø10 mm	151.SL.480.125.L.S
--	--------------------

Hansson DC Nail - SL - Right 240 mm, 125°, Ø10 mm	151.SL.240.125.R.S
---	--------------------

Hansson DC Nail - SL - Right 260 mm, 125°, Ø10 mm	151.SL.260.125.R.S
---	--------------------

Hansson DC Nail - SL - Right 280 mm, 125°, Ø10 mm	151.SL.280.125.R.S
---	--------------------

Hansson DC Nail - SL - Right 300 mm, 125°, Ø10 mm	151.SL.300.125.R.S
---	--------------------

Hansson DC Nail - SL - Right 320 mm, 125°, Ø10 mm	151.SL.320.125.R.S
---	--------------------

Hansson DC Nail - SL - Right 340 mm, 125°, Ø10 mm	151.SL.340.125.R.S
---	--------------------

Hansson DC Nail - SL - Right 360 mm, 125°, Ø10 mm	151.SL.360.125.R.S
---	--------------------

Hansson DC Nail - SL - Right 380 mm, 125°, Ø10 mm	151.SL.380.125.R.S
---	--------------------

Hansson DC Nail - SL - Right 400 mm, 125°, Ø10 mm	151.SL.400.125.R.S
---	--------------------

Hansson DC Nail - SL - Right 420 mm, 125°, Ø10 mm	151.SL.420.125.R.S
---	--------------------

Hansson DC Nail - SL - Right 440 mm, 125°, Ø10 mm	151.SL.440.125.R.S
---	--------------------

Hansson DC Nail - SL - Right 460 mm, 125°, Ø10 mm	151.SL.460.125.R.S
---	--------------------

Hansson DC Nail - SL - Right 480 mm, 125°, Ø10 mm	151.SL.480.125.R.S
---	--------------------

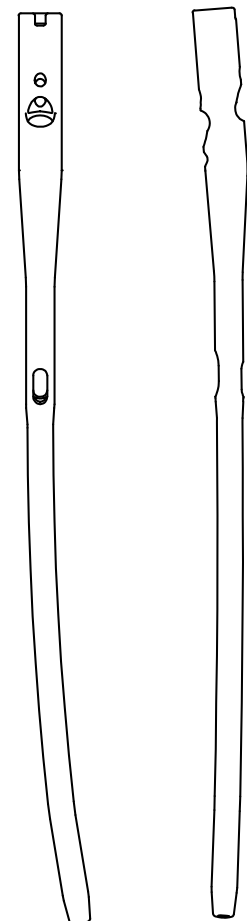
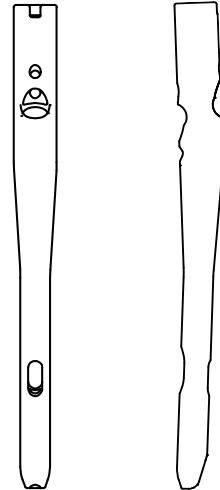



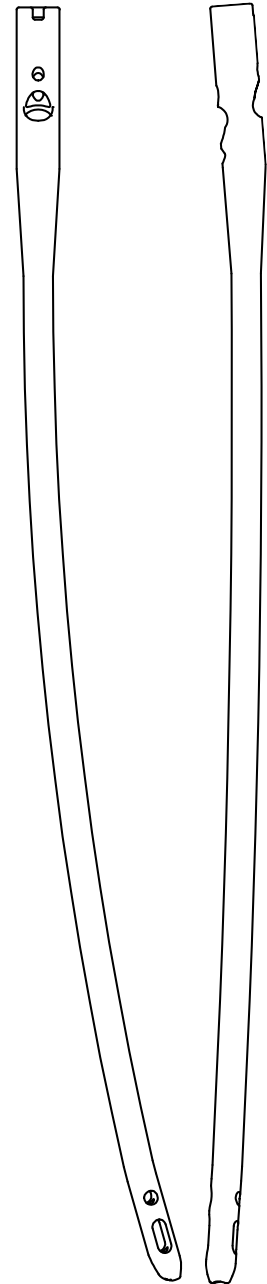

Long Nails



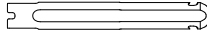
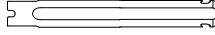
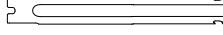
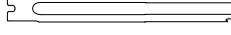
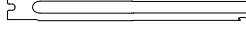
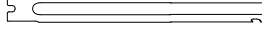
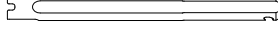
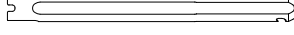







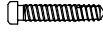

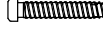



Hansson DC Nail - Long - Left 240 mm 125° Ø11 mm	151.240.125.11.L.S
Hansson DC Nail - Long - Left 260 mm 125° Ø11 mm	151.260.125.11.L.S
Hansson DC Nail - Long - Left 280 mm 125° Ø11 mm	151.280.125.11.L.S
Hansson DC Nail - Long - Left 300 mm 125° Ø11 mm	151.300.125.11.L.S
Hansson DC Nail - Long - Left 320 mm 125° Ø11 mm	151.320.125.11.L.S
Hansson DC Nail - Long - Left 340 mm 125° Ø11 mm	151.340.125.11.L.S
Hansson DC Nail - Long - Left 360 mm 125° Ø11 mm	151.360.125.11.L.S
Hansson DC Nail - Long - Left 380 mm 125° Ø11 mm	151.380.125.11.L.S
Hansson DC Nail - Long - Left 400 mm 125° Ø11 mm	151.400.125.11.L.S
Hansson DC Nail - Long - Left 420 mm 125° Ø11 mm	151.420.125.11.L.S
Hansson DC Nail - Long - Left 440 mm 125° Ø11 mm	151.440.125.11.L.S
Hansson DC Nail - Long - Left 460 mm 125° Ø11 mm	151.460.125.11.L.S
Hansson DC Nail - Long - Left 480 mm 125° Ø11 mm	151.480.125.11.L.S
Hansson DC Nail - Long - Right 240 mm 125° Ø11 mm	151.240.125.11.R.S
Hansson DC Nail - Long - Right 260 mm 125° Ø11 mm	151.260.125.11.R.S
Hansson DC Nail - Long - Right 280 mm 125° Ø11 mm	151.280.125.11.R.S
Hansson DC Nail - Long - Right 300 mm 125° Ø11 mm	151.300.125.11.R.S
Hansson DC Nail - Long - Right 320 mm 125° Ø11 mm	151.320.125.11.R.S
Hansson DC Nail - Long - Right 340 mm 125° Ø11 mm	151.340.125.11.R.S
Hansson DC Nail - Long - Right 360 mm 125° Ø11 mm	151.360.125.11.R.S
Hansson DC Nail - Long - Right 380 mm 125° Ø11 mm	151.380.125.11.R.S
Hansson DC Nail - Long - Right 400 mm 125° Ø11 mm	151.400.125.11.R.S
Hansson DC Nail - Long - Right 420 mm 125° Ø11 mm	151.420.125.11.R.S
Hansson DC Nail - Long - Right 440 mm 125° Ø11 mm	151.440.125.11.R.S
Hansson DC Nail - Long - Right 460 mm 125° Ø11 mm	151.460.125.11.R.S
Hansson DC Nail - Long - Right 480 mm 125° Ø11 mm	151.480.125.11.R.S



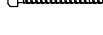



Hansson Twin Hooks

Hansson Twin Hook, Ø10.75 mm, Length 75 mm	155.0075.S	
Hansson Twin Hook, Ø10.75 mm, Length 80 mm	155.0080.S	
Hansson Twin Hook, Ø10.75 mm, Length 85 mm	155.0085.S	
Hansson Twin Hook, Ø10.75 mm, Length 90 mm	155.0090.S	
Hansson Twin Hook, Ø10.75 mm, Length 95 mm	155.0095.S	
Hansson Twin Hook, Ø10.75 mm, Length 100 mm	155.0100.S	
Hansson Twin Hook, Ø10.75 mm, Length 105 mm	155.0105.S	
Hansson Twin Hook, Ø10.75 mm, Length 110 mm	155.0110.S	
Hansson Twin Hook, Ø10.75 mm, Length 115 mm	155.0115.S	
Hansson Twin Hook, Ø10.75 mm, Length 120 mm	155.0120.S	
Hansson Twin Hook, Ø10.75 mm, Length 125 mm	155.0125.S	
Hansson Twin Hook, Ø10.75 mm, Length 130 mm	155.0130.S	

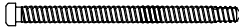
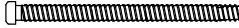
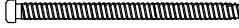
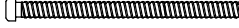
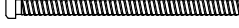
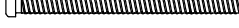
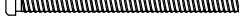
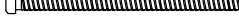
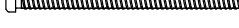
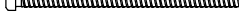
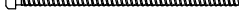
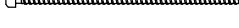
Locking Screws

Locking Screw Fully Threaded Length 26 mm, Ø5 mm	151.5026.S	
Locking Screw Fully Threaded Length 28 mm, Ø5 mm	151.5028.S	
Locking Screw Fully Threaded Length 30 mm, Ø5 mm	151.5030.S	
Locking Screw Fully Threaded Length 32 mm, Ø5 mm	151.5032.S	
Locking Screw Fully Threaded Length 34 mm, Ø5 mm	151.5034.S	
Locking Screw Fully Threaded Length 36 mm, Ø5 mm	151.5036.S	
Locking Screw Fully Threaded Length 38 mm, Ø5 mm	151.5038.S	
Locking Screw Fully Threaded Length 40 mm, Ø5 mm	151.5040.S	
Locking Screw Fully Threaded Length 42 mm, Ø5 mm	151.5042.S	
Locking Screw Fully Threaded Length 44 mm, Ø5 mm	151.5044.S	
Locking Screw Fully Threaded Length 46 mm, Ø5 mm	151.5046.S	
Locking Screw Fully Threaded Length 48 mm, Ø5 mm	151.5048.S	
Locking Screw Fully Threaded Length 50 mm, Ø5 mm	151.5050.S	
Locking Screw Fully Threaded Length 52 mm, Ø5 mm	151.5052.S	
Locking Screw Fully Threaded Length 54 mm, Ø5 mm	151.5054.S	
Locking Screw Fully Threaded Length 56 mm, Ø5 mm	151.5056.S	
Locking Screw Fully Threaded Length 58 mm, Ø5 mm	151.5058.S	
Locking Screw Fully Threaded Length 60 mm, Ø5 mm	151.5060.S	

Locking Screw Fully Threaded Length 62 mm, Ø5 mm	151.5062.S	
Locking Screw Fully Threaded Length 64 mm, Ø5 mm	151.5064.S	
Locking Screw Fully Threaded Length 66 mm, Ø5 mm	151.5066.S	
Locking Screw Fully Threaded Length 68 mm, Ø5 mm	151.5068.S	
Locking Screw Fully Threaded Length 70 mm, Ø5 mm	151.5070.S	
Locking Screw Fully Threaded Length 75 mm, Ø5 mm	151.5075.S	
Locking Screw Fully Threaded Length 80 mm, Ø5 mm	151.5080.S	
Locking Screw Fully Threaded Length 85 mm, Ø5 mm	151.5085.S	
Locking Screw Fully Threaded Length 90 mm, Ø5 mm	151.5090.S	
Locking Screw Fully Threaded Length 95 mm, Ø5 mm	151.5095.S	
Locking Screw Fully Threaded Length 100 mm, Ø5 mm	151.5100.S	
Locking Screw Fully Threaded Length 105 mm, Ø5 mm	151.5105.S	
Locking Screw Fully Threaded Length 110 mm, Ø5 mm	151.5110.S	
Locking Screw Fully Threaded Length 115 mm, Ø5 mm	151.5115.S	
Locking Screw Fully Threaded Length 120 mm, Ø5 mm	151.5120.S	
Locking Screw Fully Threaded Length 125 mm, Ø5 mm	151.5125.S	

End Caps (Hex 8 mm, Cannulation Ø3 mm)

End Cap, 0 mm extension	151.T2500.S	
End Cap, 5 mm extension	151.T2505.S	
End Cap, 10 mm extension	151.T2510.S	
End Cap, 15 mm extension	151.T2515.S	

Instruments

Tray 1 Insert Opening		151.8003
①	Threaded Guide Wire Ø3.5 mm L=450 mm	151.6002
②	Threaded Guide Wire Ø3.2 mm L=450 mm	151.6003
③	Guide Wire Pusher (Ø2.5 mm)	151.0005
④	Measuring Sleeve for Long Nail	151.7001
⑤	Opening Reamer (Ø16.4 mm, Zimmer Hall coupling)	151.3001
⑥	Handle with AO Coupling	151.1007
⑦	Curved Awl (Ø8 mm)	151.0001
⑧	Guide Sleeve for Opening Reamer	151.2002
⑨	T-Handle with Zimmer Hall Coupling	151.0004
⑩	Repositioning Guide	151.2001
⑪	Guide Wire Driver - Handle	151.0002

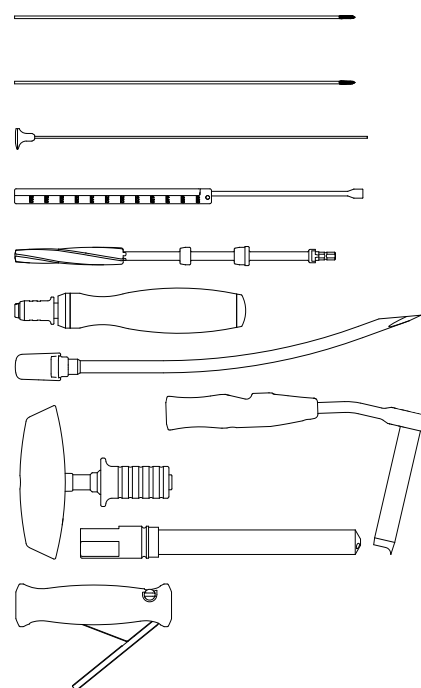

Provided separately

Guide Wire for Opening Reamer (Ball Tip Guide Wire) (Shaft Ø3 mm, Ball Ø4 mm)	151.6001
Positioning Template (AP & lateral view) Straight line	62-3101

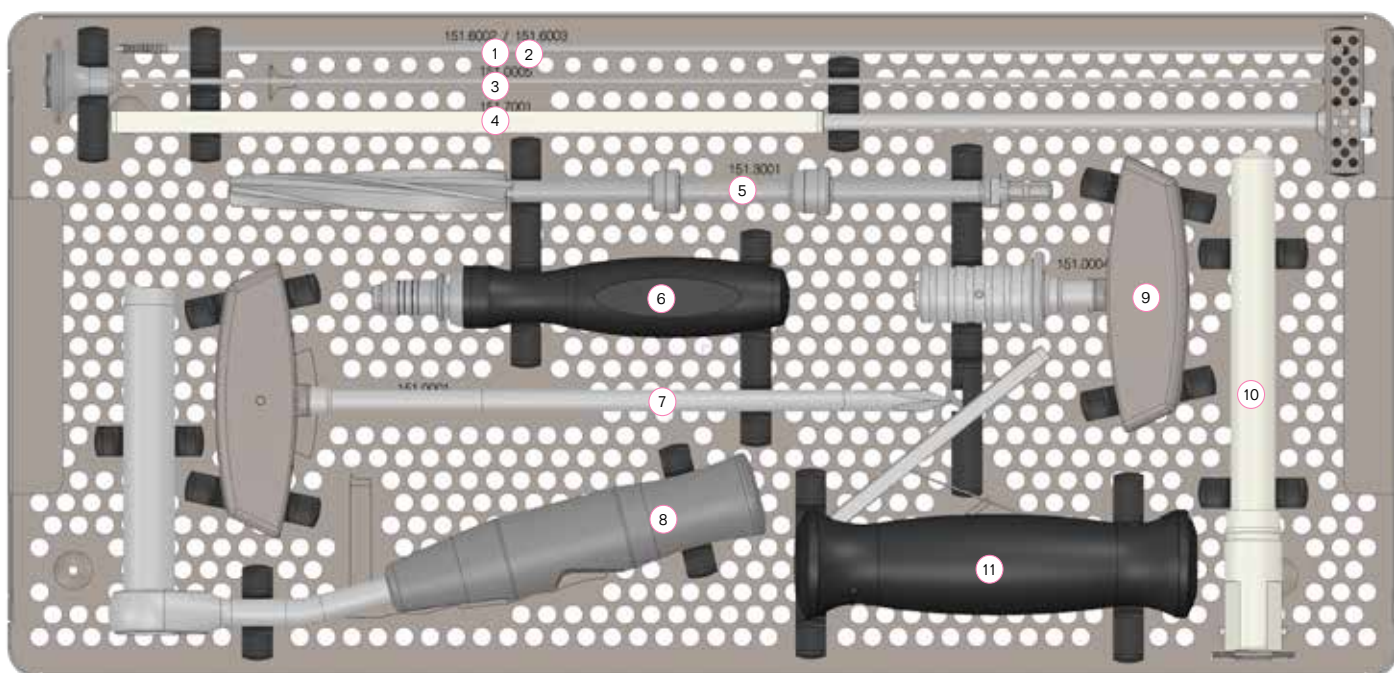

Tray 1 Base | Targeting

151.8002

1	Strike Plate	151.5001
2	Targeting Device - Sleeve 120°	151.4004
3	Targeting Device - Arm	151.4002
4	Targeting Device - Sleeve 125°	151.4005
5	Ball Tip Screwdriver (Hex 8 mm)	151.1001
6	Holding Bolt for Nail (2 included in the Tray) (Internal Hex 8 mm)	151.4007
7	Targeting Device - Sleeve 130°	151.4006
8	Positioning Guide AP - Tube	151.4009
9	Targeting Device - Knob	151.4003
10	Positioning Guide AP	151.4008

Lid (For tray 1 and tray 2)

151.8010

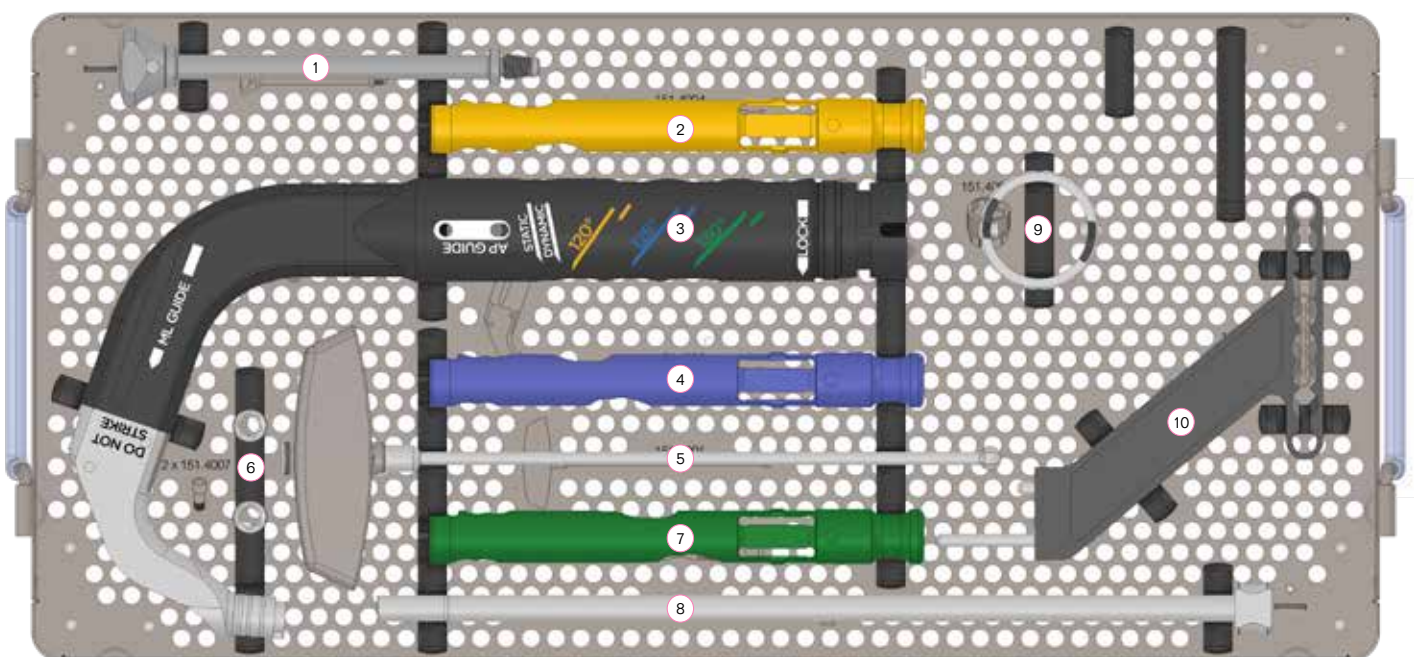
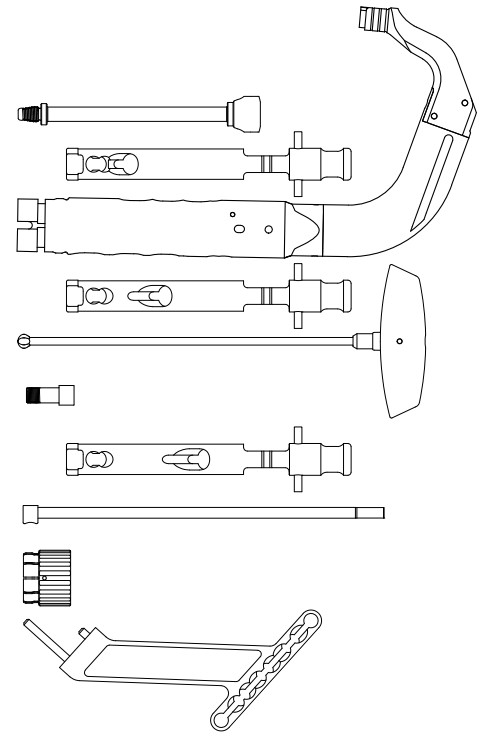

Instruments

Tray 2 Insert 1 | Hansson Twin Hook

155.8009

1	Cannulated Drill Ø10.5 mm L= 478 mm for Twin-Hook (Zimmer Hall coupling)	155.3001
2	Locknut	151.3005
3	Stop Sleeve for Drill	151.3004
4	Drill Sleeve Biaxial for Distal Notch	151.2007
5	Guide Sleeve - Biaxial	151.2005
6	Guide Sleeve - Standard	151.2003
7	Drill Sleeve Biaxial for Proximal Hole	151.2006
8	Drill for Biaxial Dynamization	151.3006
9	Twin Hook Driver (T25)	155.1001
10	Threaded Guide Wire Sleeve	151.2004
11	Outer Introducer	155.0002
12	Measuring Guide	151.7002
13	Flexible Screwdriver	151.1004
14	Inner Introducer	155.0001

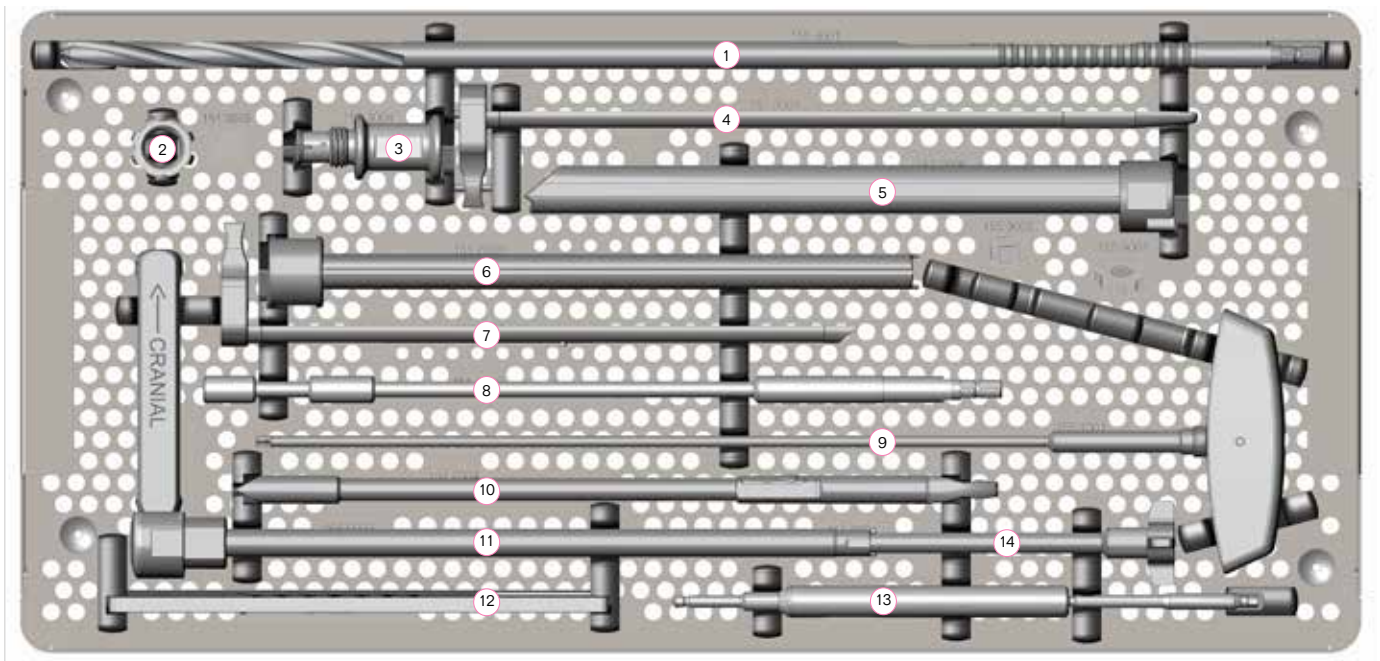
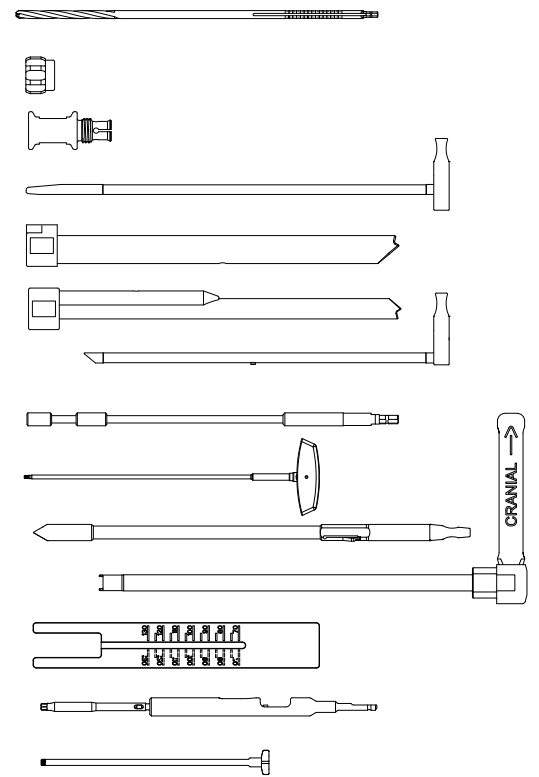

Tray 2 Base | Distal Locking & Removal

151.8007

①	Extraction Rod (Zimmer Hall coupling)	151.5002
②	Drill for Locking Screw, Long (Ø4.6 mm, AO Coupling)	151.3007
③	Drill for Locking Screw, Short (Ø4.6 mm, AO Coupling)	151.3008
④	Depth Gauge 8-125 mm	151.7004
⑤	Self-Retaining Screwdriver (T25, AO Coupling)	151.1006
⑥	Reduction Spoon (Zimmer Hall coupling)	151.0006
⑦	Trocar Tip for Locking Screw	151.2010
⑧	Screwdriver Bit (T25, AO Coupling)	151.1005
⑨	Drill Sleeve for Locking Screw	151.2009
⑩	Guide Sleeve for Locking Screw	151.2008
⑪	Hammer with Slot	151.5003
⑫	Measuring Sleeve	151.7003

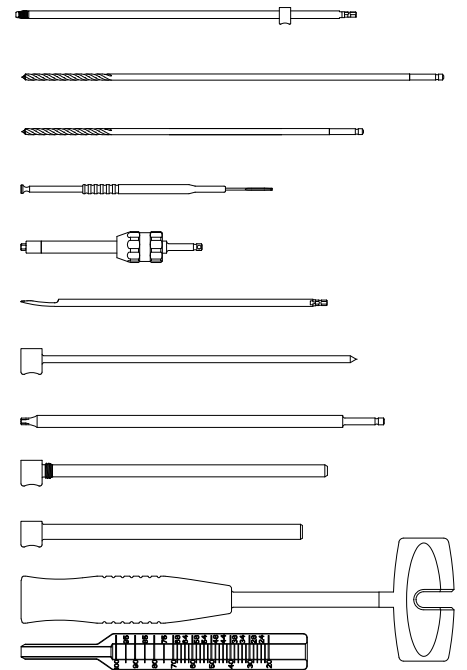

Lid (For tray 1 and tray 2)

151.8010

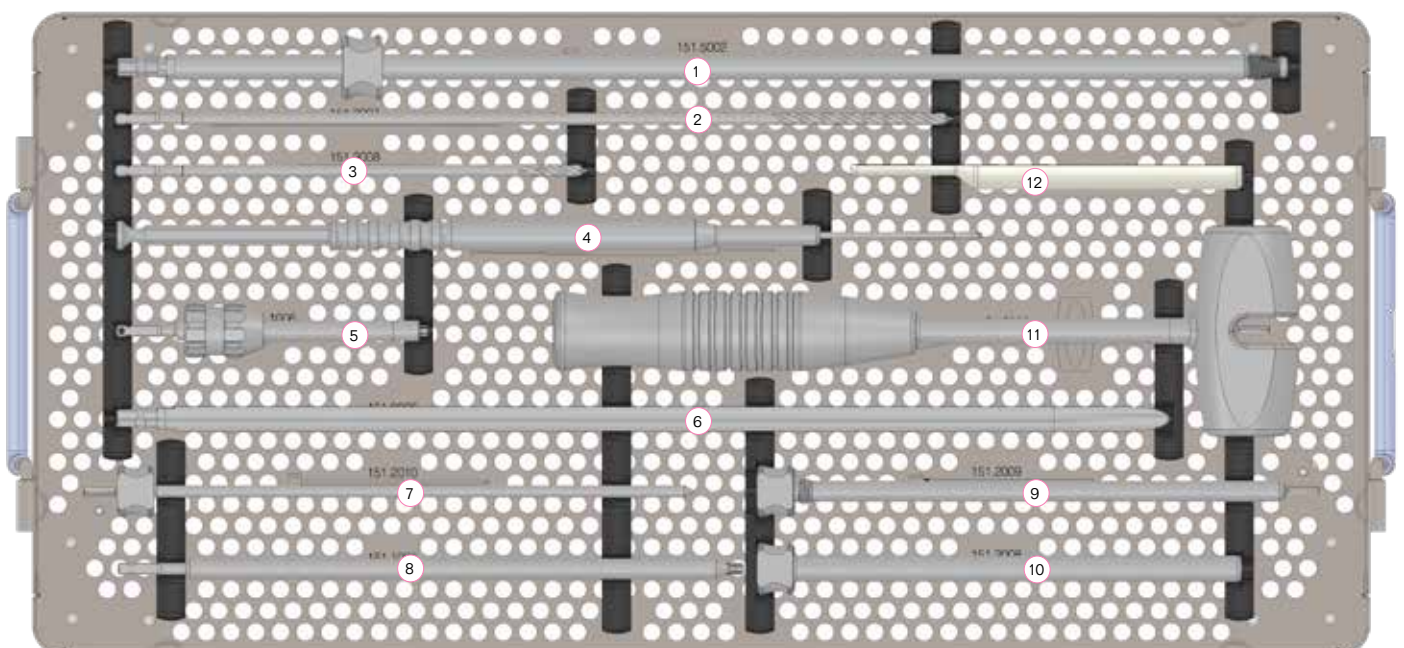

IFU

For the latest version of this Instruction For Use. Please visit:
download.swemac.com/hansson-dynamic-cephalomedullary-nail-system

Swemac

Hansson Dynamic Cephalomedullary Nail System

Manufacturer: **Swemac Innovation AB** **CE 0413**
 Cobolgatan 1 • SE-583 35 Linköping, Sweden
+46 13 37 40 30 • info@swemac.com
www.swemac.com

P151-28-2-HTH-20230116

Print date: 2023-01-16