

Sterile Container System





Organize Sanayi Bölgesi 55330
Kutlukent - SAMSUN / TÜRKİYE
Tel : 90 (362) 266 66 80 pbx
Fax : 90 (362) 266 98 44 pbx
E-Mail : aygun@aygun.com
Web : [http // www.aygun.com](http://www.aygun.com)

Edition 6

▪ According to the production programme
Aygün's rights is reserved in production to improve,
modify or delete the products declared in this catalog.

▪ The weight information given in
our catalog is approximate value.

KA - 3000-Y1 Copyright © Aygün Co., Inc
2012 All Right Reserved, Printed in Türkiye



AYGÜN, one of the leading establishment of Turkey in the medical industrial field, starting from neurosurgical field since 1988, at the end of its constantly R&D researches, has accomplished the production of instruments for all surgical branches. Along with meeting a large part of Turkey's requirements, it proves itself as an expert in the field with the products offered to the world market.

With present catalogues that include standard products and the special products formed on the request of the doctors including approximately 22.000 different types of instruments produced by AYGÜN. Besides being a manufacturer, it is also a designer firm.

Besides increasing its capacity, AYGÜN, in its new production plants constructed in the Organized Industrial Area of Samsun, aims to present the different models of products to the medical community.

www.aygun.com





MOTOR



CONTAINER



DRENAY



COLD LIGHT



INSTRUMENTS



AYGÜN, introduces to you in this catalogue that the containers with anodized aluminium and polymer cover in order to well organize the operation room and sterilization center and storage.

In order you to choose the best, Aygün provides;

- High number of dimensions
- Filter and Bio-Barrier models
- Aluminium and polymer cover varieties
- Mean of wide range of accessories
- Quality system following the standards and regulations, and Aygün takes a distinguished place among the container manufacturers in the world.

AYGÜN; in this catalog, feels pleasure to present you its production program related to Sterile Container Systems besides the production of instruments in all surgical branches.

in use of the Sterile Container Systems;

- Life of instruments usage,
- Period of sterility protection,
- Protection of hygenic situation of hospital in transporting instruments after usage
- Washing the instruments,
- Control of transportation,
- Sterility protection of set arrangement, are considered to be very useful factors.

The Sterile Container Systems, manufactured according to high quality, level of international standards and workmanship, are under guarantee of AYGÜN.



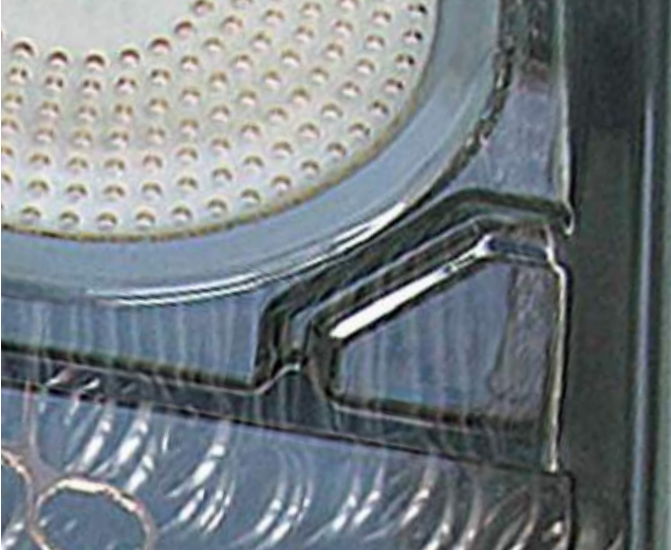

PPSU POLYMER COVER



- Container cover made of polymer have an option of six different colors and a transparent one. The cover is resistant to scratches, hits and color fading.
- Observing the inside of the container without opening the cover is only possible by the usage of the transparent covers.
- Pay attention to:
 - * Solvents such as acetone, thinner, and gas should not be used.
 - * Distilled water or water without mineral





The mechanism of the lock can stand stationary in every required position and it is adjustable into lid up to 180°



In reliable position, the containers can be put on top of each others without sliding over the sides.



The security plastic seals will be broken upon the lock is opened and this action makes it possible to follow up the sterilization process.



By means of the locking latches, the holders of the filters enable the filters be changed quickly.



The mechanism of the lock can be utilized as the lid handle.



The silicon gaskets placed around the inside of the lid, enable the security of the sterilization process.



The colored labels which give the description and the department of the sterile item, are in changeable features.

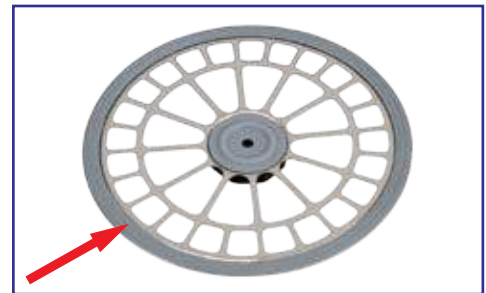

The silicon gaskets placed around the inside of the lid, enable the security of the sterilization process.



The holding pins and plates for separation wire baskets or desire.



The silicon mat, for placing the micro instruments.



Silicone handle has available in six different colors and detachable by user.



The drape retainer.



Spiral holder



Wire bottom, balanced placement and steam circulation safety.



The fixation clamps for the cylindrical instruments in different sizes.



The trolley for protection and transporting of the containers between the departments.



The method of mounting - de-mounting the safety lid of the fix model container.

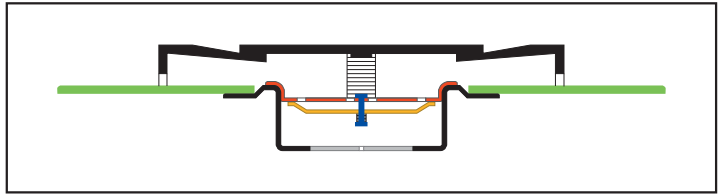

1. Before sterilization the valves are in relax position

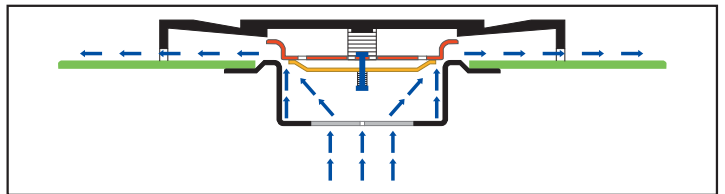

2. During the sterilization by effect of vacuum the valves are opened completely and the dry air goes out of the container.

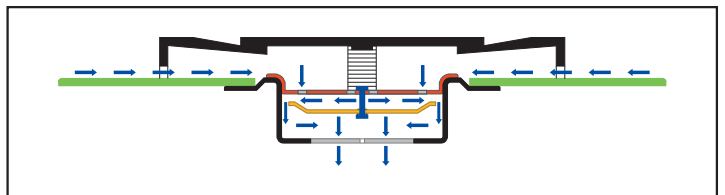

3. At the end the sterilization cycle the valves are opened in the reverse way by effect of vacuum and the sterilization cycle is completed.

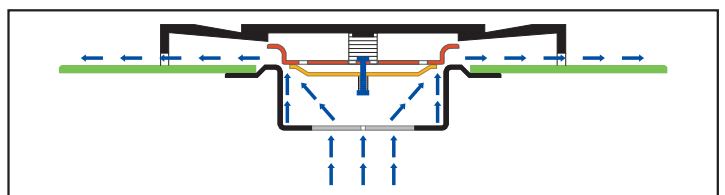

4. At the end of the sterilization cycle the sterilizer equates the pressure level and the valves of the Barrier Model Container are closed.

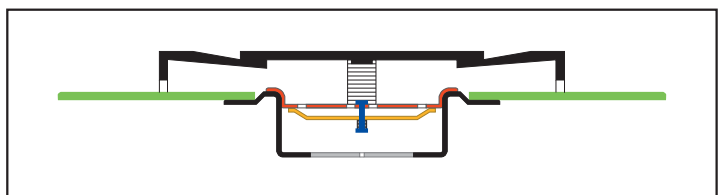

5. After sterilization the valves are in relax position.

SUITABILITY OF OUR STERILE CONTAINERS FOR STEAM STERILIZATION PROCEDURES ¹⁾ as per DIN 58953, part 9 (issue May 1987)

Sterilization container	Packing		Steam sterilization procedure acc. to DIN 58946, part 1				
	Description	Symbolic representation and packing system	Gravitation procedure	Pre-vacuum procedure	Fractional vacuum procedure	Fractional flow procedure	Steam injection procedure
with filters (StB-F)	Textiles in sterilization container with filter in lid and bottom acc. to DIN 58952 part 1		+	+	+	+	+
			○	○	+	+	+
	Textiles in sterilization container with filter in lid, bottom not perforated acc.to DIN 58952 part 1		-	-	+	+	+
			-	-	+	+	○
	Textiles in sterilization container with filter in bottom lid,not perforated acc.to DIN 58952 part 1		○	+	+	+	+
			-	○	+	+	+
	Instruments in wire basket acc. to DIN 58952 part III, in sterilization container with filter in lid and bottom acc. to DIN 58952 part 1		+ ³⁾	+	+	+	+
	Instruments in wire basket acc. to DIN 58952 part III, in sterilization container with filter in lid and bottom not perforated acc. to DIN 58952 part 1		-	+ ²⁾	+ ²⁾	+ ²⁾	+ ²⁾
	Instruments in wire basket acc. to DIN 58952 part III, in sterilization container with filter in bottom acc. to DIN 58952 part 1		○	+	+	+	+
	with Valves (StB-V)	Textiles in sterilization container with valves in lid and bottom acc. to DIN 58952 part 1		-	○	+	+
			-	-	+	+	○
Textiles in sterilization container with valves in lid no valves on the bottom			-	-	+	+	-
			-	-	+	+	-
Instruments in wire basket in sterilization container with valve in lid and bottom			-	+ ²⁾	+ ²⁾	+ ²⁾	+ ²⁾
Instruments in wire basket in sterilization container with valve in lid and not perforated			-	+ ²⁾	+ ²⁾	+ ²⁾	+ ²⁾

Explanation of symbols: **+** applicable **-** not applicable **○** limited application

1) In order to avoid mistakes with regards to service, operation and/or when loading the sterilizer, please refer to table 1 for correct or wrong combination of sterilization containers for standardized steam sterilization procedures.

2) Only sterilization containers guaranteeing evaporation or discharge of condensate are suitable above.

3) Gravitation procedures having no drying device do not guarantee a sufficient after-drying effect.











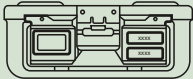

















































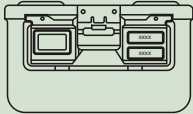























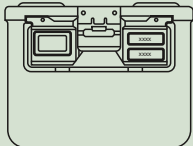























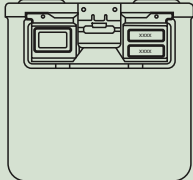





















Sterile Container System



1/1 Full Size

Classic Model

Edition 6

Specifications Sizes	Lid (Perforated)	Lid (Perforated)	Safety Lid	Safety Lid
	Box (Non-Perforated)	Box (Perforated)	Box (Non-Perforated)	Box (Perforated)
580 X 280 X 100 mm 	K6-010  K6-011  K6-012  K6-013  K6-014  K6-015 	K6-040  K6-041  K6-042  K6-043  K6-044  K6-045 	K6-150  K6-151  K6-152  K6-153  K6-154  K6-155 	K6-180  K6-181  K6-182  K6-183  K6-184  K6-185 
580 X 280 X 135 mm 	K6-016  K6-017  K6-018  K6-019  K6-020  K6-021 	K6-046  K6-047  K6-048  K6-049  K6-050  K6-051 	K6-156  K6-157  K6-158  K6-159  K6-160  K6-161 	K6-186  K6-187  K6-188  K6-189  K6-190  K6-191 
580 X 280 X 150 mm 	K6-022  K6-023  K6-024  K6-025  K6-026  K6-027 	K6-052  K6-053  K6-054  K6-055  K6-056  K6-057 	K6-162  K6-163  K6-164  K6-165  K6-166  K6-167 	K6-192  K6-193  K6-194  K6-195  K6-196  K6-197 
580 X 280 X 200 mm 	K6-028  K6-029  K6-030  K6-031  K6-032  K6-033 	K6-058  K6-059  K6-060  K6-061  K6-062  K6-063 	K6-168  K6-169  K6-170  K6-171  K6-172  K6-173 	K6-198  K6-199  K6-200  K6-201  K6-202  K6-203 
580 X 280 X 260 mm 	K6-034  K6-035  K6-036  K6-037  K6-038  K6-039 	K6-064  K6-065  K6-066  K6-067  K6-068  K6-069 	K6-174  K6-175  K6-176  K6-177  K6-178  K6-179 	K6-204  K6-205  K6-206  K6-207  K6-208  K6-209 
Ps: All container measurements cover the outer size of the lids.				
				

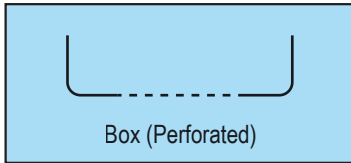

CODE	OUTSIDE	INSIDE	WEIGHT
K6-100	595 X 275 X 95 mm	543 X 260 X 75 mm	2.15 kg
K6-101	595 X 275 X 116 mm	543 X 260 X 96 mm	2.30 kg
K6-102	595 X 275 X 135 mm	543 X 260 X 115 mm	2.40 kg
K6-103	595 X 275 X 185 mm	543 X 260 X 165 mm	2.75 kg
K6-104	595 X 275 X 243 mm	543 X 260 X 223 mm	3.25 kg

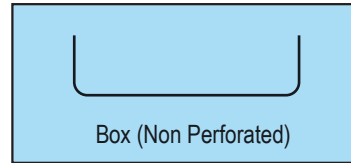

CODE	OUTSIDE	INSIDE	WEIGHT
K6-105	595 X 275 X 95 mm	543 X 260 X 90 mm	1.70 kg
K6-106	595 X 275 X 116 mm	543 X 260 X 111 mm	2.05 kg
K6-107	595 X 275 X 135 mm	543 X 260 X 130 mm	2.15 kg
K6-108	595 X 275 X 185 mm	543 X 260 X 180 mm	2.60 kg
K6-109	595 X 275 X 243 mm	543 X 260 X 238 mm	3.10 kg



Perforated Lids

Weight: 1.35 kg

K6-120	
K6-121	
K6-122	
K6-123	
K6-124	
K6-125	

Safety Lids

Weight: 1.10 kg

K6-230	
K6-231	
K6-232	
K6-233	
K6-234	
K6-235	



Removal Lids (Non Perforated)

Weight: 1.10 kg

K6-130	
K6-131	
K6-132	
K6-133	
K6-134	
K6-135	



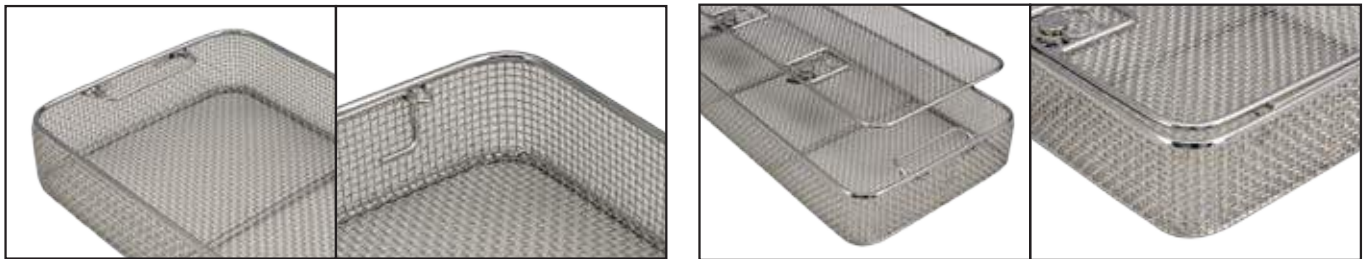

Basket Made From Stainles Steel Wire Mesh

 <p>WIRE BASKET</p>	<table border="1"> <tr><td>K2-460</td><td>540 x 250 x 30 mm</td></tr> <tr><td>K2-461</td><td>540 x 250 x 50 mm</td></tr> <tr><td>K2-462</td><td>540 x 250 x 70 mm</td></tr> <tr><td>K2-463</td><td>540 x 250 x 100 mm</td></tr> </table>	K2-460	540 x 250 x 30 mm	K2-461	540 x 250 x 50 mm	K2-462	540 x 250 x 70 mm	K2-463	540 x 250 x 100 mm	 <p>WIRE BASKET WITH LID</p>	<table border="1"> <tr><td>K3-1010</td><td>540 x 250 x 30 mm</td></tr> <tr><td>K3-1011</td><td>540 x 250 x 50 mm</td></tr> <tr><td>K3-1012</td><td>540 x 250 x 70 mm</td></tr> <tr><td>K3-1013</td><td>540 x 250 x 100 mm</td></tr> </table>	K3-1010	540 x 250 x 30 mm	K3-1011	540 x 250 x 50 mm	K3-1012	540 x 250 x 70 mm	K3-1013	540 x 250 x 100 mm
	K2-460	540 x 250 x 30 mm																	
K2-461	540 x 250 x 50 mm																		
K2-462	540 x 250 x 70 mm																		
K2-463	540 x 250 x 100 mm																		
K3-1010	540 x 250 x 30 mm																		
K3-1011	540 x 250 x 50 mm																		
K3-1012	540 x 250 x 70 mm																		
K3-1013	540 x 250 x 100 mm																		
<table border="1"> <tr><td>K2-450</td><td>480 x 250 x 30 mm</td></tr> <tr><td>K2-451</td><td>480 x 250 x 50 mm</td></tr> <tr><td>K2-452</td><td>480 x 250 x 70 mm</td></tr> <tr><td>K2-453</td><td>480 x 250 x 100 mm</td></tr> </table>	K2-450	480 x 250 x 30 mm	K2-451	480 x 250 x 50 mm	K2-452	480 x 250 x 70 mm	K2-453	480 x 250 x 100 mm	<table border="1"> <tr><td>K3-1014</td><td>ONLY LID, for baskets</td></tr> </table>	K3-1014	ONLY LID, for baskets								
K2-450	480 x 250 x 30 mm																		
K2-451	480 x 250 x 50 mm																		
K2-452	480 x 250 x 70 mm																		
K2-453	480 x 250 x 100 mm																		
K3-1014	ONLY LID, for baskets																		



Wire Basket With Perforated Metal Plate

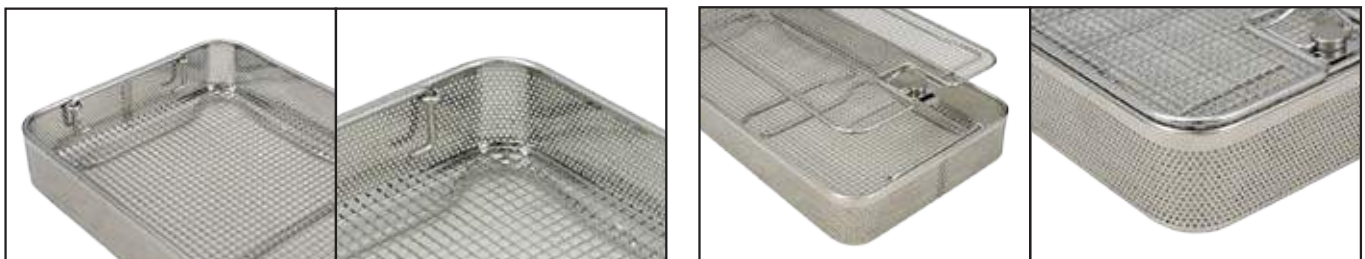

 <p>WIRE BASKET</p>	<table border="1"> <tr><td>K2-461 P</td><td>540 x 250 x 50 mm</td></tr> <tr><td>K2-462 P</td><td>540 x 250 x 70 mm</td></tr> <tr><td>K2-463 P</td><td>540 x 250 x 100 mm</td></tr> </table>	K2-461 P	540 x 250 x 50 mm	K2-462 P	540 x 250 x 70 mm	K2-463 P	540 x 250 x 100 mm	 <p>WIRE BASKET WITH LID</p>	<table border="1"> <tr><td>K3-1011 P</td><td>540 x 250 x 50 mm</td></tr> <tr><td>K3-1012 P</td><td>540 x 250 x 70 mm</td></tr> <tr><td>K3-1013 P</td><td>540 x 250 x 100 mm</td></tr> </table>	K3-1011 P	540 x 250 x 50 mm	K3-1012 P	540 x 250 x 70 mm	K3-1013 P	540 x 250 x 100 mm
	K2-461 P	540 x 250 x 50 mm													
K2-462 P	540 x 250 x 70 mm														
K2-463 P	540 x 250 x 100 mm														
K3-1011 P	540 x 250 x 50 mm														
K3-1012 P	540 x 250 x 70 mm														
K3-1013 P	540 x 250 x 100 mm														
<table border="1"> <tr><td>K2-451 P</td><td>480 x 250 x 50 mm</td></tr> <tr><td>K2-452 P</td><td>480 x 250 x 70 mm</td></tr> <tr><td>K2-453 P</td><td>480 x 250 x 100 mm</td></tr> </table>	K2-451 P	480 x 250 x 50 mm	K2-452 P	480 x 250 x 70 mm	K2-453 P	480 x 250 x 100 mm	<table border="1"> <tr><td>K3-1014 P</td><td>ONLY LID, for baskets</td></tr> </table>	K3-1014 P	ONLY LID, for baskets						
K2-451 P	480 x 250 x 50 mm														
K2-452 P	480 x 250 x 70 mm														
K2-453 P	480 x 250 x 100 mm														
K3-1014 P	ONLY LID, for baskets														

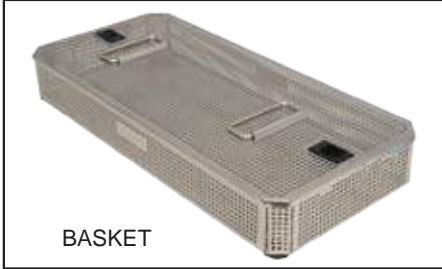

Basket Made From Stainles Steel Sheet



BASKET



	K3-720 540 x 253 x 30 mm K3-721 540 x 253 x 50 mm K3-722 540 x 253 x 70 mm K3-723 540 x 253 x 100 mm
	K3-740 540 x 253 x 30 mm K3-741 540 x 253 x 50 mm K3-742 540 x 253 x 70 mm K3-743 540 x 253 x 100 mm
	K3-760 540 x 253 x 10 mm

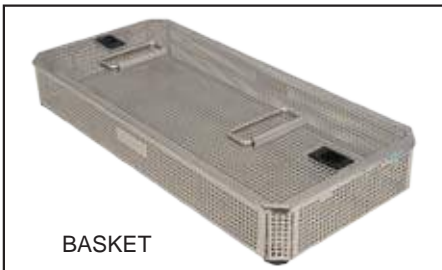

K3-767
Stand
Height 20 mm



BASKET

	K3-724 485 x 253 x 30 mm K3-725 485 x 253 x 50 mm K3-726 485 x 253 x 70 mm K3-727 485 x 253 x 100 mm
	K3-744 485 x 253 x 30 mm K3-745 485 x 253 x 50 mm K3-746 485 x 253 x 70 mm K3-747 485 x 253 x 100 mm
	K3-761 540 x 253 x 10 mm



K3-768
Stand
Height 14 mm





K2-560 RED
K2-561 BLUE
K2-562 GREEN
K2-563 YELLOW
K2-564 GREY
K2-565 BLACK



K2-570
K2-571
K2-572
K2-573
K2-574
K2-575

Coloured identification labels Engraved to your specification

Grey coloured recommended for use in Sterrad.
Color fading By effect of Hydrogen Peroxide Gas Plasma on other colors.



K2-569
Information board with clip



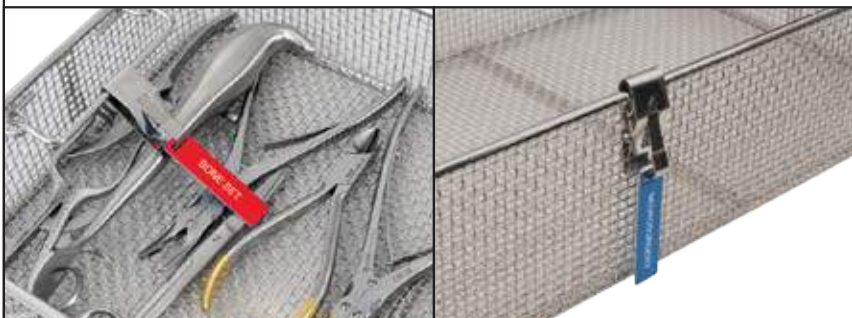



K2-428 540 x 250 x 130 mm
K2-429 540 x 250 x 180 mm
DIVIDERS



K2-440 545 x 255 x 30 mm
WIRE BASE



K2-425 540 x 250 x 130 mm
K2-426 540 x 250 x 180 mm
DIVIDERS

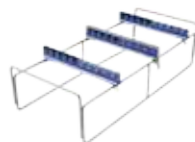

K3-1090
Rack for endoscopy
Holds 10 endoscopic instruments
Fits into a 1/1 size 20 cm deep container

Wire basket 1/1 50 mm
Container 1/1 200 mm
Silicone mat 520 x 230 mm



K2-420 545 x 255 x 30 mm
DRAPE RETAINER



K2-400 545 x 255 mm
DRAPE RETAINER



K3-1119 245 x 130 x 55 mm
Aluminium basket, with lid



K3-1120 245 x 130 x 70 mm
Aluminium basket, with lid



K3-1121 245 x 130 x 105 mm
Aluminium basket, with lid



K2-526 520 x 230 mm
K2-528 470 x 230 mm
Silicone mat



K2-531 480 x 250 x 2.0 mm
Silicone mat



K2-700
K2-701
K2-702
K2-703
K2-704
K2-705



K2-740
Single use paper filter 100 pcs with indicator



K2-742
Teflon filter
Number of sterilization cycle > 1200



K2-730
Filter Dispenser



K2-710 Red
K2-711 Yellow
K2-712 Green
K2-713 Blue
K2-714 Grey
K2-715 Black



K2-673
Labels, paper 100 pcs.
With indicator.

For small size and special containers



K2-672
Labels, paper 100 pcs.
With indicator.

For full and half size containers



K2-663
Security seal, made of plastic 100 pcs. with indicator. (Blue)



K2-664
Security seal, made of plastic 100 pcs.(Blue)



K2-661
Security seal, made of plastic 100 pcs. with number.(Blue)



K2-662
Security seal, made of plastic 100 pcs. with indicator.(Red)



K2-660
Security seal, made of plastic 100 pcs.(Red)



K2-665
Security seal, made of plastic 100 pcs. with number.(Red)



K2-717 40 x 35 x 9 mm
Disposal stamp
Requested number or letter must be informed during the order.



K2-716 50 x 35 x 13 mm
Holder for identification labels











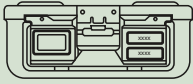







































































(-)

Sterile Container System



3/4 Quarter Size

Classic Model

Specifications Sizes	Lid (Perforated)	Lid (Perforated)	Safety Lid	Safety Lid
	Box (Non-Perforated)	Box (Perforated)	Box (Non-Perforated)	Box (Perforated)
465 X 280 X 100 mm 	K6-240  K6-241  K6-242  K6-243  K6-244  K6-245 	K6-260  K6-261  K6-262  K6-263  K6-264  K6-265 	K6-350  K6-351  K6-352  K6-353  K6-354  K6-355 	K6-370  K6-371  K6-372  K6-373  K6-374  K6-375 
465 X 280 X 135 mm 	K6-246  K6-247  K6-248  K6-249  K6-250  K6-251 	K6-266  K6-267  K6-268  K6-269  K6-270  K6-271 	K6-356  K6-357  K6-358  K6-359  K6-360  K6-361 	K6-376  K6-377  K6-378  K6-379  K6-380  K6-381 
465 X 280 X 150 mm 	K6-252  K6-253  K6-254  K6-255  K6-256  K6-257 	K6-272  K6-273  K6-274  K6-275  K6-276  K6-277 	K6-362  K6-363  K6-364  K6-365  K6-366  K6-367 	K6-382  K6-383  K6-384  K6-385  K6-386  K6-387 
Ps: All container measurements cover the outer size of the lids.				
				

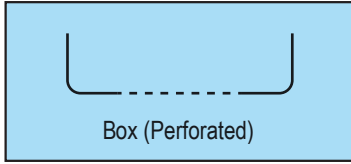

CODE	OUTSIDE	INSIDE	WEIGHT
K6-300	475 X 275 X 95 mm	422 X 260 X 90 mm	1.65 kg
K6-301	475 X 275 X 116 mm	422 X 260 X 96 mm	1.80 kg
K6-302	475 X 275 X 137 mm	422 X 260 X 117 mm	1.95 kg

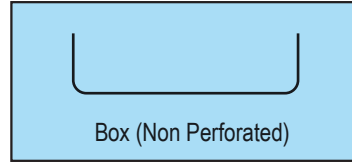

CODE	OUTSIDE	INSIDE	WEIGHT
K6-305	475 X 275 X 95 mm	422 X 260 X 90 mm	1.50 kg
K6-306	475 X 275 X 116 mm	422 X 260 X 111 mm	1.65 kg
K6-307	475 X 275 X 137 mm	422 X 260 X 132 mm	1.75 kg



Perforated Lids

Weight: 0.95 kg

- K6-340**
- K6-341**
- K6-342**
- K6-343**
- K6-344**
- K6-345**

Safety Lids

Weight: 0.90 kg

- K6-410**
- K6-411**
- K6-412**
- K6-413**
- K6-414**
- K6-415**



Removal Lids (Non Perforated)

Weight: 0.85 kg

- K6-320**
- K6-321**
- K6-322**
- K6-323**
- K6-324**
- K6-325**



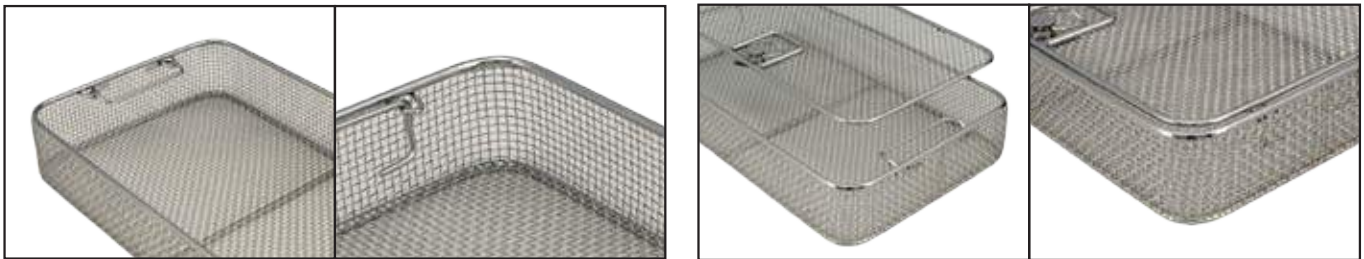

Basket Made From Stainles Steel Wire Mesh

 <p>K2-1500 405 x 250 x 30 mm K2-1501 405 x 250 x 50 mm K2-1502 405 x 250 x 70 mm K2-1503 405 x 250 x 100 mm</p> <p>WIRE BASKET</p>	 <p>K3-1030 405 x 250 x 30 mm K3-1031 405 x 250 x 50 mm K3-1032 405 x 250 x 70 mm K3-1033 405 x 250 x 100 mm K3-1034 ONLY LID, for baskets</p> <p>WIRE BASKET WITH LID</p>
---	---



Wire Basket With Perforated Metal Plate

 <p>K2-1501 P 405 x 250 x 50 mm K2-1502 P 405 x 250 x 70 mm K2-1503 P 405 x 250 x 100 mm</p> <p>WIRE BASKET</p>	 <p>K3-1031 P 405 x 250 x 50 mm K3-1032 P 405 x 250 x 70 mm K3-1033 P 405 x 250 x 100 mm K3-1034 P ONLY LID, for baskets</p> <p>WIRE BASKET WITH LID</p>
---	---

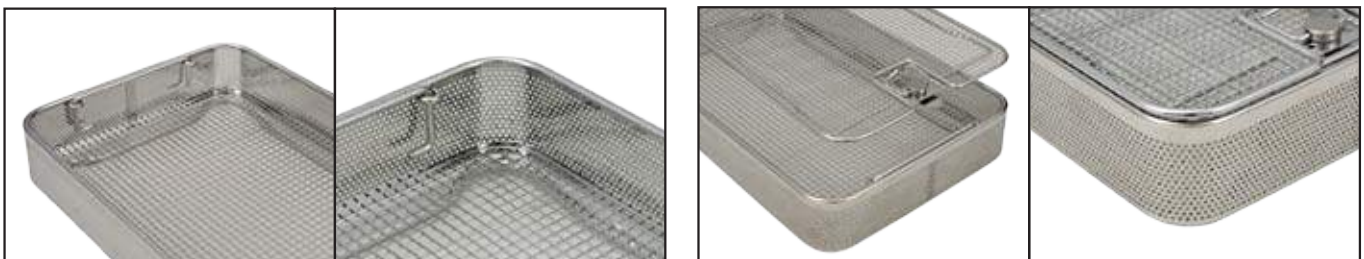

Basket Made From Stainless Steel Sheet



 Box and Lid	K3-728 405 x 253 x 30 mm
	K3-729 405 x 253 x 50 mm
	K3-730 405 x 253 x 70 mm
	K3-731 405 x 253 x 100 mm
 Box	K3-748 405 x 253 x 30 mm
	K3-749 405 x 253 x 50 mm
	K3-750 405 x 253 x 70 mm
	K3-751 405 x 253 x 100 mm
	K3-762 405 x 253 x 10 mm
 Lid	



	<p>K2-560 RED</p> <p>K2-561 BLUE</p> <p>K2-562 GREEN</p> <p>K2-563 YELLOW</p> <p>K2-564 GREY</p> <p>K2-565 BLACK</p>		<p>K2-570</p> <p>K2-571</p> <p>K2-572</p> <p>K2-573</p> <p>K2-574</p> <p>K2-575</p> <p>Coloured identification labels Engraved to your specification</p>
--	--	--	--

Grey coloured recommended for use in Sterrad.
Color fading By effect of Hydrogen Peroxide Gas Plasma on other colors.

K2-569
Information board with clip

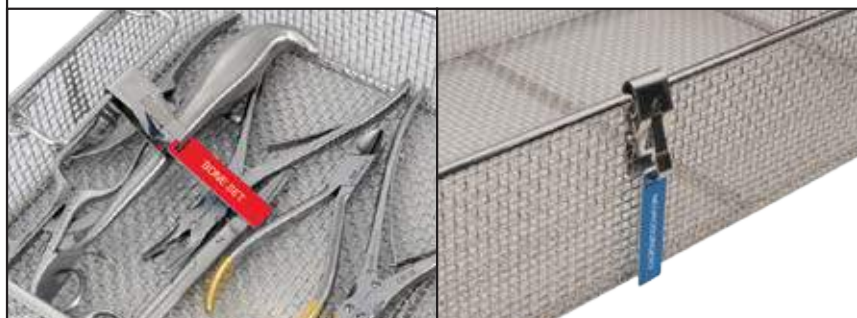

3/4 Accessories



Sterile Container Systems



K2-1540 405 x 250 x 80 mm
K2-1541 405 x 250 x 110 mm
K2-1542 405 x 250 x 130 mm
 DIVIDERS



K2-1522 405 x 255 x 30 mm
 WIRE BASE



K2-1530 405 x 250 x 80 mm
K2-1531 405 x 250 x 110 mm
K2-1532 405 x 250 x 130 mm
 DIVIDERS

(-)



K2-1521 405 x 255 x 30 mm
 DRAPE RETAINER



K2-1520 405 x 255 mm
 DRAPE RETAINER



K3-1119 245 x 130 x 55 mm
 Aluminium basket, with lid



K3-1120 245 x 130 x 70 mm
 Aluminium basket, with lid



K3-1121 245 x 130 x 105 mm
 Aluminium basket, with lid



K2-524 380 x 230 mm
K2-525 440 x 230 mm
 Silicone mat



K2-531 480 x 250 x 2.0 mm
 Silicone mat



K2-700
K2-701
K2-702
K2-703
K2-704
K2-705



K2-740
 Single use paper filter 100 pcs with indicator



K2-742
 Teflon filter
 Number of sterilization cycle > 1200



K2-730
 Filter Dispenser



K2-710 Red
K2-711 Yellow
K2-712 Green
K2-713 Blue
K2-714 Grey
K2-715 Black



K2-673
 Labels, paper 100 pcs.
 With indicator.
 For small size and special containers



K2-672
 Labels, paper 100 pcs.
 With indicator.
 For full and half size containers



K2-663
 Security seal, made of plastic
 100 pcs. with indicator. (Blue)



K2-664
 Security seal, made of plastic
 100 pcs (Blue)



K2-661
 Security seal, made of plastic
 100 pcs. with number.(Blue)



K2-662
 Security seal, made of plastic
 100 pcs. with indicator.(Red)



K2-660
 Security seal, made of plastic
 100 pcs.(Red)



K2-665
 Security seal, made of plastic
 100 pcs. with number.(Red)



K2-717 40 x 35 x 9 mm
 Disposal stamp
 Requested number or letter
 must be informed during
 the order.



K2-716 50 x 35 x 13 mm
 Holder for identification labels







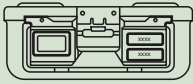
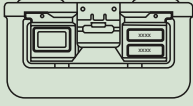
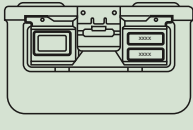
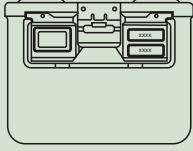
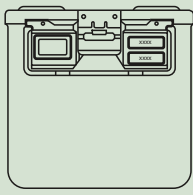

(-)

Sterile Container System



1/2 Half Size

Classic Model

Specifications Sizes	Lid (Perforated)	Lid (Perforated)	Safety Lid	Safety Lid
	Box (Non-Perforated)	Box (Perforated)	Box (Non-Perforated)	Box (Perforated)
285 X 280 X 100 mm 	K6-500 K6-501 K6-502 K6-503 K6-504 K6-505	K6-530 K6-531 K6-532 K6-533 K6-534 K6-535	K6-640 K6-641 K6-642 K6-643 K6-644 K6-645	K6-670 K6-671 K6-672 K6-673 K6-674 K6-675
285 X 280 X 135 mm 	K6-506 K6-507 K6-508 K6-509 K6-510 K6-511	K6-536 K6-537 K6-538 K6-539 K6-540 K6-541	K6-646 K6-647 K6-648 K6-649 K6-650 K6-651	K6-676 K6-677 K6-678 K6-679 K6-680 K6-681
285 X 280 X 150 mm 	K6-512 K6-513 K6-514 K6-515 K6-516 K6-517	K6-542 K6-543 K6-544 K6-545 K6-546 K6-547	K6-652 K6-653 K6-654 K6-655 K6-656 K6-657	K6-682 K6-683 K6-684 K6-685 K6-686 K6-687
285 X 280 X 200 mm 	K6-518 K6-519 K6-520 K6-521 K6-522 K6-523	K6-548 K6-549 K6-550 K6-551 K6-552 K6-553	K6-658 K6-659 K6-660 K6-661 K6-662 K6-663	K6-688 K6-689 K6-690 K6-691 K6-692 K6-693
285 X 280 X 260 mm 	K6-524 K6-525 K6-526 K6-527 K6-528 K6-529	K6-554 K6-555 K6-556 K6-557 K6-558 K6-559	K6-664 K6-665 K6-666 K6-667 K6-668 K6-669	K6-694 K6-695 K6-696 K6-697 K6-698 K6-699
Ps: All container measurements cover the outer size of the lids.				
				

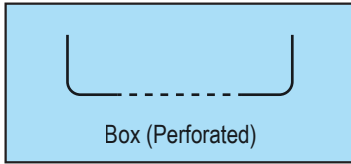

CODE	OUTSIDE	INSIDE	WEIGHT
K6-600	306 X 272 X 95 mm	253 X 258 X 75 mm	1.25 kg
K6-601	306 X 272 X 114 mm	253 X 258 X 94 mm	1.40 kg
K6-602	306 X 272 X 135 mm	253 X 258 X 115 mm	1.55 kg
K6-603	306 X 272 X 184 mm	253 X 258 X 164 mm	1.80 kg
K6-604	306 X 272 X 241 mm	253 X 258 X 221 mm	2.10 kg

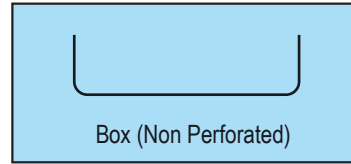

CODE	OUTSIDE	INSIDE	WEIGHT
K6-605	306 X 272 X 95 mm	253 X 258 X 90 mm	1.15 kg
K6-606	306 X 272 X 114 mm	253 X 258 X 109 mm	1.25 kg
K6-607	306 X 272 X 135 mm	253 X 258 X 130 mm	1.35 kg
K6-608	306 X 272 X 184 mm	253 X 258 X 179 mm	1.55 kg
K6-609	306 X 272 X 241 mm	253 X 258 X 236 mm	2.00 kg



Perforated Lids

Weight: 0.70 kg

K6-630	Grey
K6-631	Yellow
K6-632	Green
K6-633	Blue
K6-634	Red
K6-635	Black

Safety Lids

Weight: 0.55 kg

K6-700	Grey
K6-701	Yellow
K6-702	Green
K6-703	Blue
K6-704	Red
K6-705	Black

Removal Lids (Non Perforated)



Weight: 0.60 kg

K6-620	Grey
K6-621	Yellow
K6-622	Green
K6-623	Blue
K6-624	Red
K6-625	Black





- GREY
- YELLOW
- GREEN
- BLUE
- RED
- BLACK

Basket Made From Stainles Steel Wire Mesh

 <p>K2-490 255 x 250 x 30 mm K2-491 255 x 250 x 50 mm K2-492 255 x 250 x 70 mm K2-493 255 x 250 x 100 mm</p> <p>WIRE BASKET</p>	 <p>K3-1040 255 x 250 x 30 mm K3-1041 255 x 250 x 50 mm K3-1042 255 x 250 x 70 mm K3-1043 255 x 250 x 100 mm K3-1045 ONLY LID, for baskets</p> <p>WIRE BASKET WITH LID</p>
---	---



Wire Basket With Perforated Metal Plate



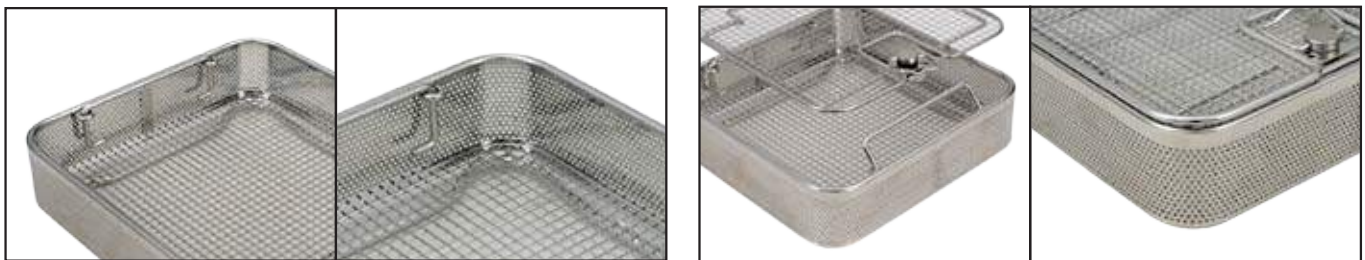

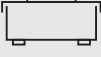
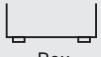
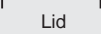

 <p>K2-491 P 255 x 250 x 50 mm K2-492 P 255 x 250 x 70 mm K2-493 P 255 x 250 x 100 mm</p> <p>WIRE BASKET</p>	 <p>K3-1041 P 255 x 250 x 50 mm K3-1042 P 255 x 250 x 70 mm K3-1043 P 255 x 250 x 100 mm K3-1045 P ONLY LID, for baskets</p> <p>WIRE BASKET WITH LID</p>
--	---



Basket Made From Stainless Steel Sheet

 <p>BASKET</p>	 <p>Box and Lid</p>	<p>K3-732 244 x 253 x 30 mm K3-733 244 x 253 x 50 mm K3-734 244 x 253 x 70 mm K3-735 244 x 253 x 100 mm</p>
	 <p>Box</p>	<p>K3-752 244 x 253 x 30 mm K3-753 244 x 253 x 50 mm K3-754 244 x 253 x 70 mm K3-755 244 x 253 x 100 mm</p>
	 <p>Lid</p>	<p>K3-763 244 x 253 x 10 mm</p>

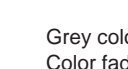

 <p>K2-560 RED</p>	 <p>K2-570 (Red) K2-571 (Blue) K2-572 (Green) K2-573 (Yellow) K2-574 (Grey) K2-575 (Black)</p> <p>Coloured identification labels Engraved to your specification</p>
 <p>K2-561 BLUE</p>	
 <p>K2-562 GREEN</p>	
 <p>K2-563 YELLOW</p>	
 <p>K2-564 GREY</p>	
 <p>K2-565 BLACK</p>	

Grey coloured recommended for use in Sterrad.
 Color fading By effect of Hydrogen Peroxide Gas Plasma on other colors.



K2-569
Information board with clip



1/2 Accessories

AYGUN®

Sterile Container Systems



K2-483 255 x 245 x 130 mm
K2-484 255 x 245x 180 mm
DIVIDERS



K2-482 255 x 255 x 30 mm
WIRE BASE

(-)



K3-1094
Rack for kerrison punches
Holds 10 kerrison punches
Fits into a 1/2 and 1/1 size
20 cm deep container

Wire basket 1/2 50 mm
Wire basket 1/1 50 mm
Container 1/2 200 mm
Container 1/2 200 mm



K3-481 255 x 255 x 30 mm
DRAPE RETAINER



K2-480 255 x 255 mm
DRAPE RETAINER



K3-1119 245 x 130 x 55 mm
Aluminium basket, with lid



K3-1120 245 x 130 x 70 mm
Aluminium basket, with lid



K3-1121 245 x 130 x 105 mm
Aluminium basket, with lid



K2-521 255 x 255 mm
Silicone mat

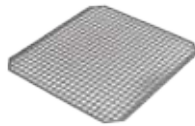

K2-531 480 x 250 x 2.0 mm
Silicone mat



K2-700 Red
K2-701 Blue
K2-702 Green
K2-703 Yellow
K2-704 Grey
K2-705 Black



K2-740
Single use paper filter 100 pcs
with indicator



K2-742
Teflon filter
Number of sterilization
cycle > 1200



K2-730
Filter Dispenser



K2-710 Red
K2-711 Yellow
K2-712 Green
K2-713 Blue
K2-714 Grey
K2-715 Black



K2-673
Labels, paper 100 pcs.
With indicator.

For small size and special
containers



K2-672
Labels, paper 100 pcs.
With indicator.

For full and half size containers



K2-663
Security seal, made of plastic
100 pcs. with indicator. (Blue)



K2-664
Security seal, made of plastic
100 pcs.(Blue)



K2-661
Security seal, made of plastic
100 pcs. with number.(Blue)



K2-662
Security seal, made of plastic
100 pcs. with indicator.(Red)



K2-660
Security seal, made of
plastic 100 pcs.(Red)



K2-665
Security seal, made of plastic
100 pcs. with number.(Red)



K2-717 40 x 35 x 9 mm
Disposal stamp
Requested number or letter
must be informed during
the order.



K2-716 50 x 35 x 13 mm
Holder for identification labels











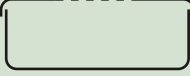
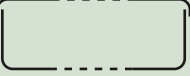
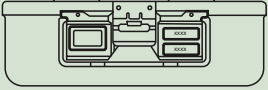















(-)

Sterile Container System



XL Size

Classic Model

<p>Specifications</p> <p>Sizes</p>	<p>Lid (Perforated)</p>  <p>Box (Non-Perforated)</p>	<p>Lid (Perforated)</p>  <p>Box (Perforated)</p>
<p>590 X 370 X 120 mm</p> 	<p>K6-136 </p> <p>K6-137 </p> <p>K6-138 </p> <p>K6-139 </p> <p>K6-140 </p> <p>K6-141 </p>	<p>K6-210 </p> <p>K6-211 </p> <p>K6-212 </p> <p>K6-213 </p> <p>K6-214 </p> <p>K6-215 </p>
<p>590 X 370 X 180 mm</p> 	<p>K6-142 </p> <p>K6-143 </p> <p>K6-144 </p> <p>K6-145 </p> <p>K6-146 </p> <p>K6-147 </p>	<p>K6-216 </p> <p>K6-217 </p> <p>K6-218 </p> <p>K6-219 </p> <p>K6-220 </p> <p>K6-221 </p>
<p>Ps: All container measurements cover the outer size of the lids.</p>		

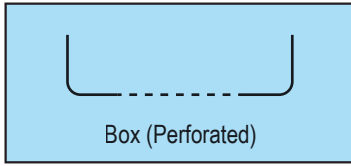

CODE	OUTSIDE	INSIDE	WEIGHT
K6-400	595 X 365 X 105 mm	530 X 350 X 85 mm	2.50 kg
K6-401	595 X 365 X 167 mm	530 X 350 X 145 mm	3.25 kg

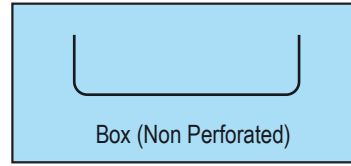

CODE	OUTSIDE	INSIDE	WEIGHT
K6-402	595 X 365 X 105 mm	543 X 350 X 100 mm	2.20 kg
K6-403	595 X 365 X 167 mm	530 X 350 X 162 mm	3.00 kg





Perforated Lids

Weight: 1.65 kg





K6-326	
K6-327	
K6-328	
K6-329	
K6-330	
K6-331	

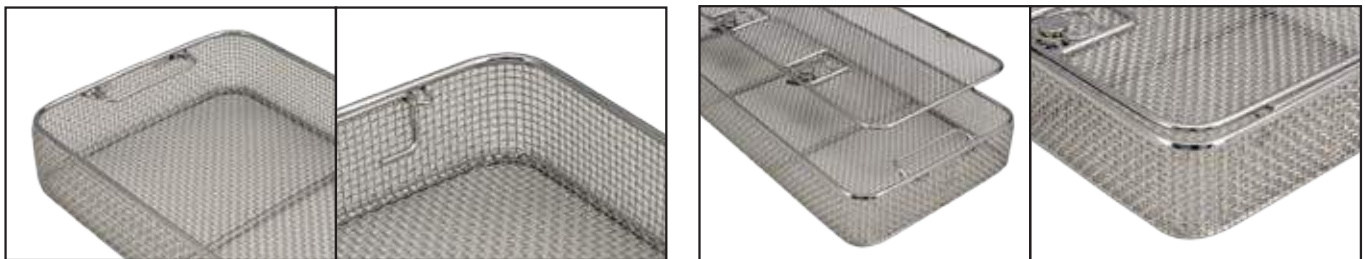

Basket Made From Stainles Steel Wire Mesh

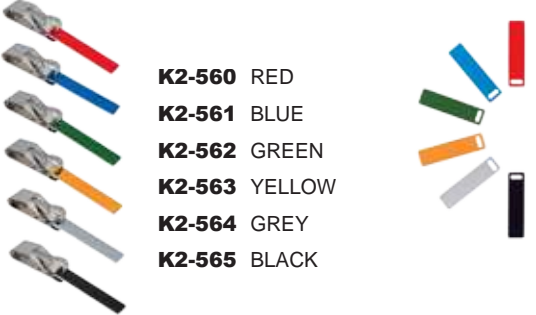
 <p>K2-1701 533 x 337 x 50 mm K2-1702 533 x 337 x 75 mm K2-1703 533 x 337 x 100 mm</p> <p>WIRE BASKET</p>	 <p>K3-1704 533 x 337 x 50 mm K3-1705 533 x 337 x 75 mm K3-1706 533 x 337 x 100 mm K3-1707 ONLY LID, for baskets</p> <p>WIRE BASKET WITH LID</p>
---	---



 <p>K2-560 RED K2-561 BLUE K2-562 GREEN K2-563 YELLOW K2-564 GREY K2-565 BLACK</p> <p>K2-570 K2-571 K2-572 K2-573 K2-574 K2-575</p> <p>Coloured identification labels Engraved to your specification</p> <p>Grey coloured recommended for use in Sterrad. Color fading By effect of Hydrogen Peroxide Gas Plasma on other colors.</p>	 <p>K2-569 Information board with clip</p> 
 	

XL Accessories



Sterile Container Systems



K2-1731 533 x 337 x 70 mm
K2-1732 533 x 337 x 120 mm
DIVIDERS

(-)



K2-1721 533 x 337 x 70 mm
K2-1722 533 x 337 x 120 mm
DIVIDERS

(-)



K2-1712 533 x 337 x 30 mm
DRAPE RETAINER



K2-1711 533 x 337 mm
DRAPE RETAINER

(-)

(-)



K3-1119 245 x 130 x 55 mm
Aluminium basket, with lid



K3-1120 245 x 130 x 70 mm
Aluminium basket, with lid



K3-1121 245 x 130 x 105 mm
Aluminium basket, with lid



K2-740
Single use paper filter 100 pcs with indicator



K2-742
Teflon filter
Number of sterilization cycle > 1200



K2-730
Filter Dispenser



K2-710 Red
K2-711 Yellow
K2-712 Green
K2-713 Blue
K2-714 Grey
K2-715 Black



K2-673
Labels, paper 100 pcs.
With indicator.

For small size and special containers



K2-672
Labels, paper 100 pcs.
With indicator.

For full and half size containers



K2-663
Security seal, made of plastic 100 pcs. with indicator. (Blue)



K2-664
Security seal, made of plastic 100 pcs.(Blue)



K2-661
Security seal, made of plastic 100 pcs. with number.(Blue)



K2-662
Security seal, made of plastic 100 pcs. with indicator.(Red)



K2-660
Security seal, made of plastic 100 pcs.(Red)



K2-665
Security seal, made of plastic 100 pcs. with number.(Red)



K2-717 40 x 35 x 9 mm
Disposal stamp
Requested number or letter must be informed during the order.



K2-716 50 x 35 x 13 mm
Holder for identification labels

(-)



The method of mounting - de-mounting the safety lid of the fix model container.



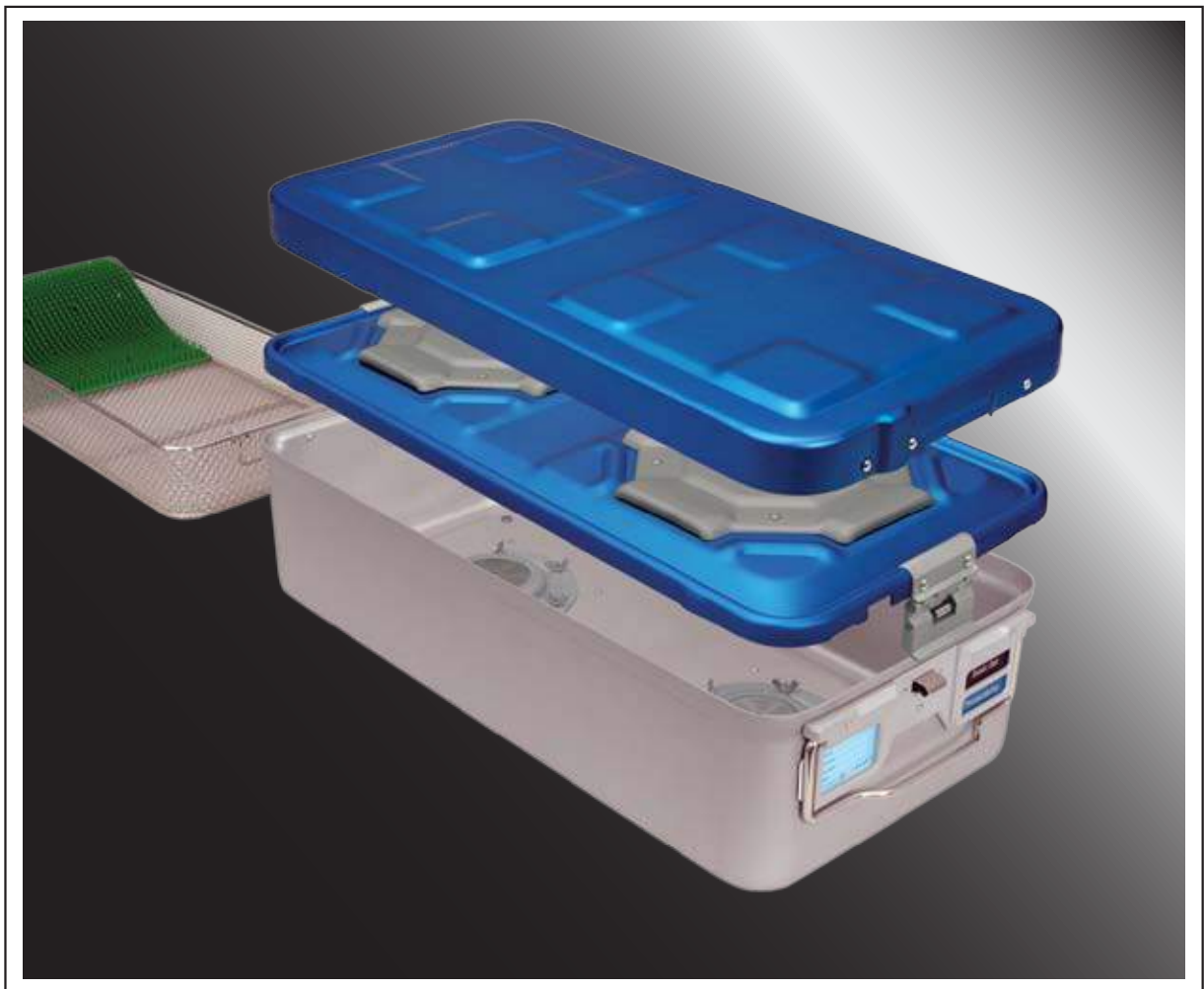







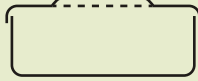
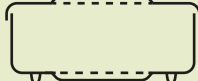

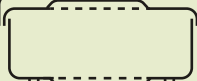
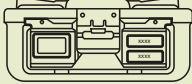























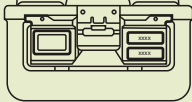























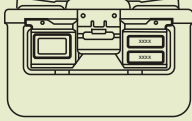























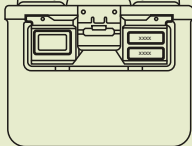























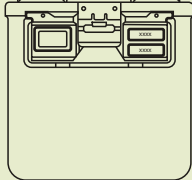













Sterile Container System



1/1 Full Size

Bio-Barrier Model

Edition 6

Specifications Sizes	Lid (with barrier)  Box (Non-Perforated)	Lid (with barrier)  Box (with barrier)	Safety Lid Lid (with barrier)  Box (Non-Perforated)	Safety Lid Lid (with barrier)  Box (with barrier)				
	580 X 280 X h mm 	K7-010  K7-011  K7-012  K7-013  K7-014  K7-015 	h= 115 mm	K7-040  K7-041  K7-042  K7-043  K7-044  K7-045 	h= 135 mm	K7-150  K7-151  K7-152  K7-153  K7-154  K7-155 	h= 128 mm	K7-180  K7-181  K7-182  K7-183  K7-184  K7-185 
580 X 280 X h mm 	K7-016  K7-017  K7-018  K7-019  K7-020  K7-021 	h= 140 mm	K7-046  K7-047  K7-048  K7-049  K7-050  K7-051 	h= 163 mm	K7-156  K7-157  K7-158  K7-159  K7-160  K7-161 	h= 153 mm	K7-186  K7-187  K7-188  K7-189  K7-190  K7-191 	h= 170 mm
580 X 280 X h mm 	K7-022  K7-023  K7-024  K7-025  K7-026  K7-027 	h= 155 mm	K7-052  K7-053  K7-054  K7-055  K7-056  K7-057 	h= 175 mm	K7-162  K7-163  K7-164  K7-165  K7-166  K7-167 	h= 168 mm	K7-192  K7-193  K7-194  K7-195  K7-196  K7-197 	h= 185 mm
580 X 280 X h mm 	K7-028  K7-029  K7-030  K7-031  K7-032  K7-033 	h= 205 mm	K7-058  K7-059  K7-060  K7-061  K7-062  K7-063 	h= 235 mm	K7-168  K7-169  K7-170  K7-171  K7-172  K7-173 	h= 218 mm	K7-198  K7-199  K7-200  K7-201  K7-202  K7-203 	h= 245 mm
580 X 280 X h mm 	K7-034  K7-035  K7-036  K7-037  K7-038  K7-039 	h= 265 mm	K7-064  K7-065  K7-066  K7-067  K7-068  K7-069 	h= 295 mm	K7-174  K7-175  K7-176  K7-177  K7-178  K7-179 	h= 278 mm	K7-204  K7-205  K7-206  K7-207  K7-208  K7-209 	h= 305 mm

Ps: All container measurements cover the outer size of the lids.



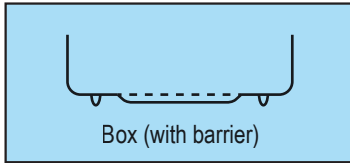

CODE	OUTSIDE	INSIDE	WEIGHT
K7-100	595 X 275 X 115 mm	543 X 260 X 90 mm	2.70 kg
K7-101	595 X 275 X 136 mm	543 X 260 X 111 mm	3.20 kg
K7-102	595 X 275 X 155 mm	543 X 260 X 130 mm	3.40 kg
K7-103	595 X 275 X 205 mm	543 X 260 X 180 mm	4.10 kg
K7-104	595 X 275 X 263 mm	543 X 260 X 238 mm	4.90 kg

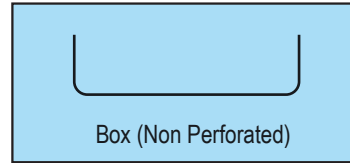

CODE	OUTSIDE	INSIDE	WEIGHT
K7-105	595 X 275 X 95 mm	543 X 260 X 90 mm	1.70 kg
K7-106	595 X 275 X 116 mm	543 X 260 X 111 mm	2.05 kg
K7-107	595 X 275 X 135 mm	543 X 260 X 130 mm	2.15 kg
K7-108	595 X 275 X 185 mm	543 X 260 X 180 mm	2.60 kg
K7-109	595 X 275 X 243 mm	543 X 260 X 238 mm	3.10 kg



Lid Barrier system

Weight: 1.85 kg

K7-120	
K7-121	
K7-122	
K7-123	
K7-124	
K7-125	

Safety Lids



Weight: 1.21 kg

K7-400	
K7-401	
K7-402	
K7-403	
K7-404	
K7-405	





- GREY
- YELLOW
- GREEN
- BLUE
- RED
- BLACK

Basket Made From Stainless Steel Wire Mesh

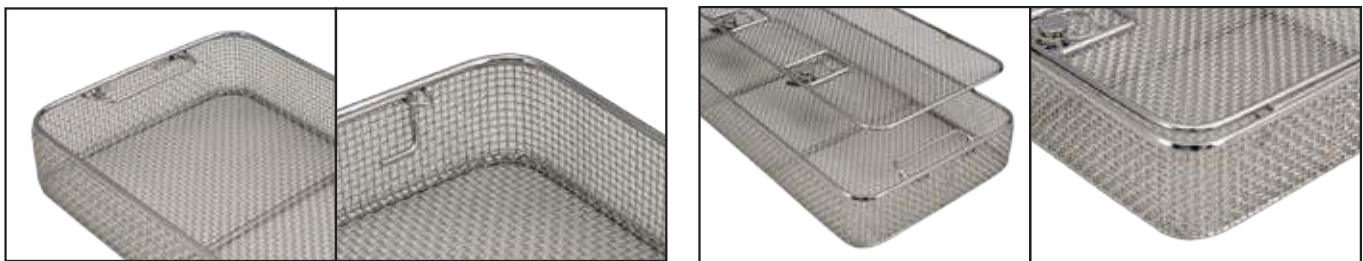
 <p>WIRE BASKET</p>	<p>K2-460 540 x 250 x 30 mm</p> <p>K2-461 540 x 250 x 50 mm</p> <p>K2-462 540 x 250 x 70 mm</p> <p>K2-463 540 x 250 x 100 mm</p>	 <p>WIRE BASKET WITH LID</p>	<p>K3-1010 540 x 250 x 30 mm</p> <p>K3-1011 540 x 250 x 50 mm</p> <p>K3-1012 540 x 250 x 70 mm</p> <p>K3-1013 540 x 250 x 100 mm</p>
	<p>K2-450 480 x 250 x 30 mm</p> <p>K2-451 480 x 250 x 50 mm</p> <p>K2-452 480 x 250 x 70 mm</p> <p>K2-453 480 x 250 x 100 mm</p>		<p>K3-1014 ONLY LID, for baskets</p> <p>K3-1020 480 x 250 x 30 mm</p> <p>K3-1021 480 x 250 x 50 mm</p> <p>K3-1022 480 x 250 x 70 mm</p> <p>K3-1023 480 x 250 x 100 mm</p>



Wire Basket With Perforated Metal Plate

 <p>WIRE BASKET</p>	<p>K2-461 P 540 x 250 x 50 mm</p> <p>K2-462 P 540 x 250 x 70 mm</p> <p>K2-463 P 540 x 250 x 100 mm</p>	 <p>WIRE BASKET WITH LID</p>	<p>K3-1011 P 540 x 250 x 50 mm</p> <p>K3-1012 P 540 x 250 x 70 mm</p> <p>K3-1013 P 540 x 250 x 100 mm</p>
	<p>K2-451 P 480 x 250 x 50 mm</p> <p>K2-452 P 480 x 250 x 70 mm</p> <p>K2-453 P 480 x 250 x 100 mm</p>		<p>K3-1014 P ONLY LID, for baskets</p> <p>K3-1021 P 480 x 250 x 50 mm</p> <p>K3-1022 P 480 x 250 x 70 mm</p> <p>K3-1023 P 480 x 250 x 100 mm</p>

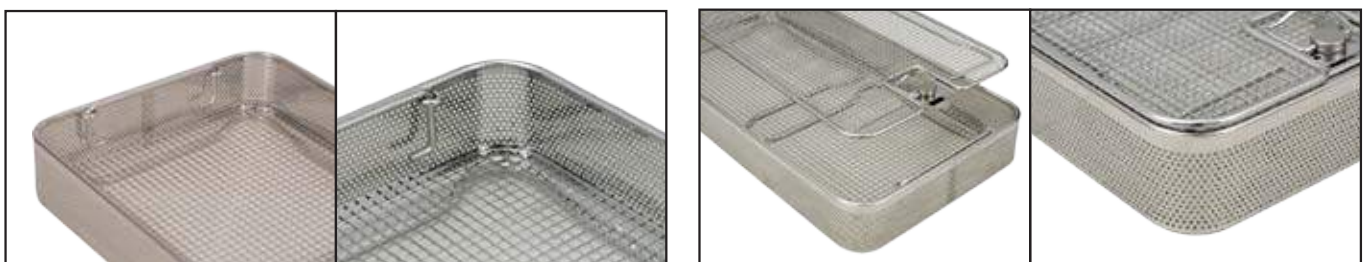

Basket Made From Stainles Steel Sheet



BASKET

	K3-720 540 x 253 x 30 mm
	K3-721 540 x 253 x 50 mm
	K3-722 540 x 253 x 70 mm
	K3-723 540 x 253 x 100 mm
	K3-740 540 x 253 x 30 mm
	K3-741 540 x 253 x 50 mm
	K3-742 540 x 253 x 70 mm
	K3-743 540 x 253 x 100 mm
	K3-760 540 x 253 x 10 mm



K3-767
Stand
Height 20 mm



BASKET

	K3-724 485 x 253 x 30 mm
	K3-725 485 x 253 x 50 mm
	K3-726 485 x 253 x 70 mm
	K3-727 485 x 253 x 100 mm
	K3-744 485 x 253 x 30 mm
	K3-745 485 x 253 x 50 mm
	K3-746 485 x 253 x 70 mm
	K3-747 485 x 253 x 100 mm
	K3-761 540 x 253 x 10 mm



K3-768
Stand
Height 14 mm



- K2-560** RED
- K2-561** BLUE
- K2-562** GREEN
- K2-563** YELLOW
- K2-564** GREY
- K2-565** BLACK

- K2-570**
- K2-571**
- K2-572**
- K2-573**
- K2-574**
- K2-575**

Coloured identification labels Engraved to your specification

Grey coloured recommended for use in Sterrad.
Color fading By effect of Hydrogen Peroxide Gas Plasma on other colors.

K2-569
Information board with clip

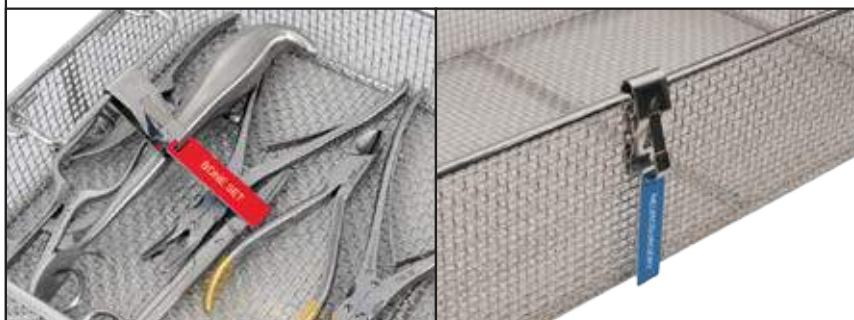



K2-428 540 x 250 x 130 mm
K2-429 540 x 250 x 180 mm
DIVIDERS



K2-440 545 x 255 x 30 mm
WIRE BASE



K2-425 540 x 250 x 130 mm
K2-426 540 x 250 x 180 mm
DIVIDERS

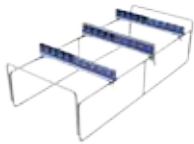

K3-1090
Rack for endoscopy
Holds 10 endoscopic instruments
Fits into a 1/1 size 20 cm deep container

Wire basket 1/1 50 mm
Container 1/1 200 mm
Silicone mat 520 x 230 mm

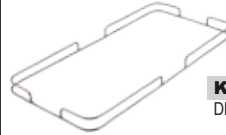

K2-420 545 x 255 x 30 mm
DRAPE RETAINER



K2-400 545 x 255 mm
DRAPE RETAINER



K3-1119 245 x 130 x 55 mm
Aluminium basket, with lid



K3-1120 245 x 130 x 70 mm
Aluminium basket, with lid



K3-1121 245 x 130 x 105 mm
Aluminium basket, with lid



K2-526 520 x 230 mm
K2-528 470 x 230 mm
Silicone mat



K2-531 480 x 250 x 2.0 mm
Silicone mat



K2-700 Red
K2-701 Blue
K2-702 Green
K2-703 Yellow
K2-704 Grey
K2-705 Black



K2-710 Red
K2-711 Yellow
K2-712 Green
K2-713 Blue
K2-714 Grey
K2-715 Black



K2-673
Labels, paper 100 pcs.
With indicator.

For small size and special containers



K2-672
Labels, paper 100 pcs.
With indicator.

For full and half size containers



K2-663
Security seal, made of plastic
100 pcs. with indicator. (Blue)



K2-664
Security seal, made of plastic
100 pcs.(Blue)



K2-661
Security seal, made of plastic
100 pcs. with number.(Blue)



K2-662
Security seal, made of plastic
100 pcs. with indicator.(Red)



K2-660
Security seal, made of plastic
100 pcs.(Red)



K2-665
Security seal, made of plastic
100 pcs. with number.(Red)



K2-717 40 x 35 x 9 mm
Disposal stamp
Requested number or letter
must be informed during
the order.







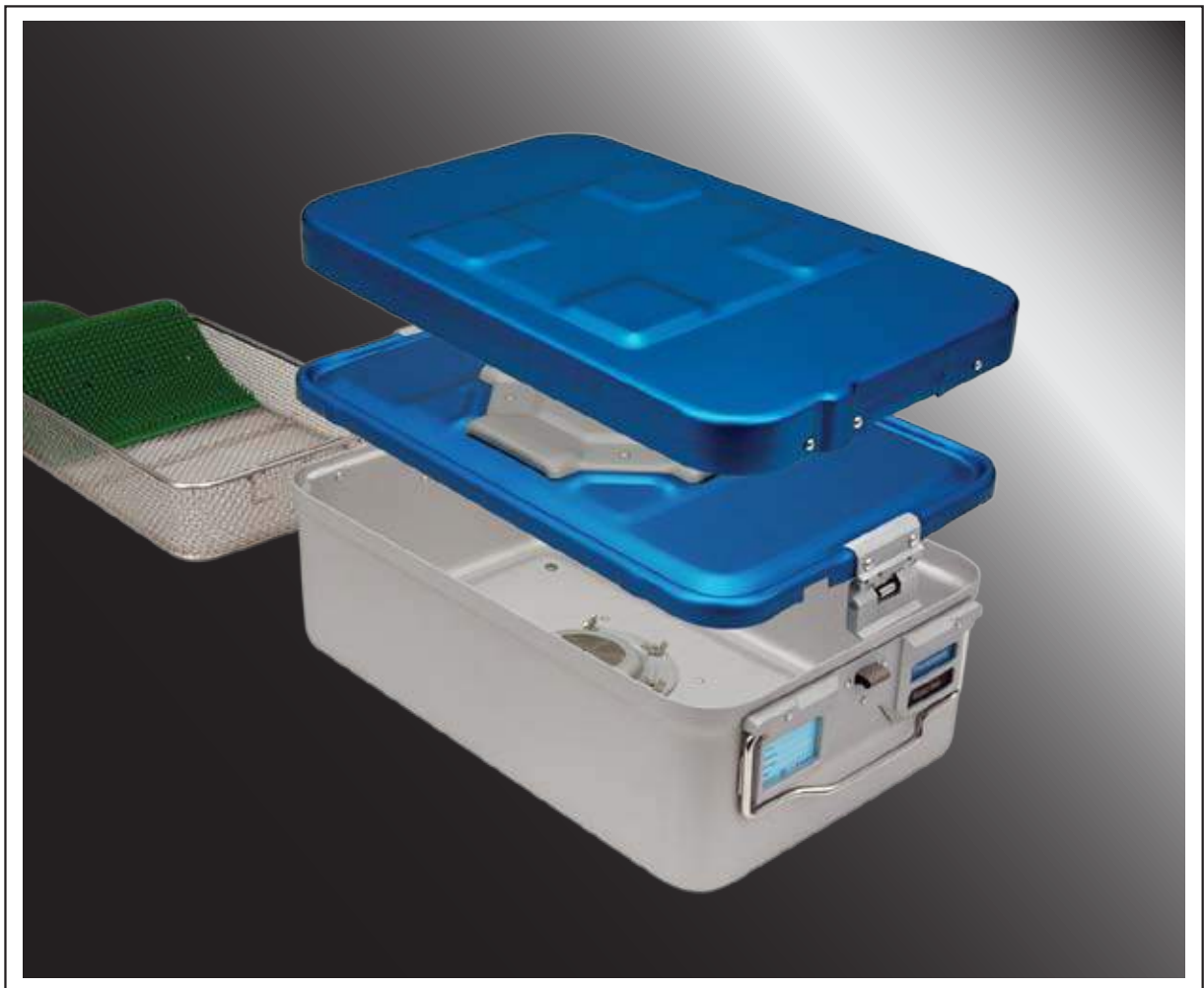





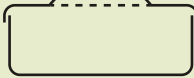
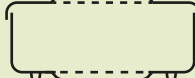

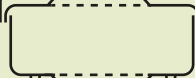

























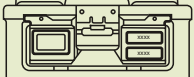















































K2-716 50 x 35 x 13 mm
Holder for identification labels

Sterile Container System



3/4 Quarter Size

Bio-Barrier Model

<p>Specifications</p> <p>Sizes</p>	<p>Lid (with barrier)</p>  <p>Box (Non-Perforated)</p>	<p>Lid (with barrier)</p>  <p>Box (with barrier)</p>	<p>Safety Lid Lid (with barrier)</p>  <p>Box (Non-Perforated)</p>	<p>Safety Lid Lid (with barrier)</p>  <p>Box (with barrier)</p>
<p>465 X 280 X h mm</p> 	<p>K7-240 </p> <p>K7-241 </p> <p>K7-242 </p> <p>K7-243 </p> <p>K7-244 </p> <p>K7-245 </p> <p style="text-align: center;">h = 115 mm</p>	<p>K7-260 </p> <p>K7-261 </p> <p>K7-262 </p> <p>K7-263 </p> <p>K7-264 </p> <p>K7-265 </p> <p style="text-align: center;">h = 135 mm</p>	<p>K7-350 </p> <p>K7-351 </p> <p>K7-352 </p> <p>K7-353 </p> <p>K7-354 </p> <p>K7-355 </p> <p style="text-align: center;">h = 128 mm</p>	<p>K7-370 </p> <p>K7-371 </p> <p>K7-372 </p> <p>K7-373 </p> <p>K7-374 </p> <p>K7-375 </p> <p style="text-align: center;">h = 150 mm</p>
<p>465 X 280 X h mm</p> 	<p>K7-246 </p> <p>K7-247 </p> <p>K7-248 </p> <p>K7-249 </p> <p>K7-250 </p> <p>K7-251 </p> <p style="text-align: center;">h = 140 mm</p>	<p>K7-266 </p> <p>K7-267 </p> <p>K7-268 </p> <p>K7-269 </p> <p>K7-270 </p> <p>K7-271 </p> <p style="text-align: center;">h = 160 mm</p>	<p>K7-356 </p> <p>K7-357 </p> <p>K7-358 </p> <p>K7-359 </p> <p>K7-360 </p> <p>K7-361 </p> <p style="text-align: center;">h = 153 mm</p>	<p>K7-376 </p> <p>K7-377 </p> <p>K7-378 </p> <p>K7-379 </p> <p>K7-380 </p> <p>K7-381 </p> <p style="text-align: center;">h = 175 mm</p>
<p>465 X 280 X h mm</p> 	<p>K7-252 </p> <p>K7-253 </p> <p>K7-254 </p> <p>K7-255 </p> <p>K7-256 </p> <p>K7-257 </p> <p style="text-align: center;">h = 155 mm</p>	<p>K7-272 </p> <p>K7-273 </p> <p>K7-274 </p> <p>K7-275 </p> <p>K7-276 </p> <p>K7-277 </p> <p style="text-align: center;">h = 175 mm</p>	<p>K7-362 </p> <p>K7-363 </p> <p>K7-364 </p> <p>K7-365 </p> <p>K7-366 </p> <p>K7-367 </p> <p style="text-align: center;">h = 168 mm</p>	<p>K7-382 </p> <p>K7-383 </p> <p>K7-384 </p> <p>K7-385 </p> <p>K7-386 </p> <p>K7-387 </p> <p style="text-align: center;">h = 185 mm</p>
<p>Ps: All container measurements cover the outer size of the lids.</p>				
				

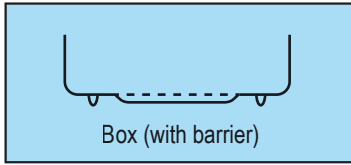

CODE	OUTSIDE	INSIDE	WEIGHT
K7-300	475 X 275 X 115 mm	422 X 260 X 90 mm	1.95 kg
K7-301	475 X 275 X 136 mm	422 X 260 X 111 mm	2.10 kg
K7-302	475 X 275 X 157 mm	422 X 260 X 132 mm	2.20 kg

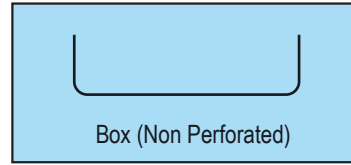

CODE	OUTSIDE	INSIDE	WEIGHT
K7-305	475 X 275 X 95 mm	422 X 260 X 90 mm	1.50 kg
K7-306	475 X 275 X 116 mm	422 X 260 X 111 mm	1.65 kg
K7-307	475 X 275 X 137 mm	422 X 260 X 132 mm	1.75 kg



Lid Barrier System

Weight: 1.285 kg

- K7-340**
- K7-341**
- K7-342**
- K7-343**
- K7-344**
- K7-345**



Safety Lids

Weight: 0.94 kg

- K7-406**
- K7-407**
- K7-408**
- K7-409**
- K7-410**
- K7-411**



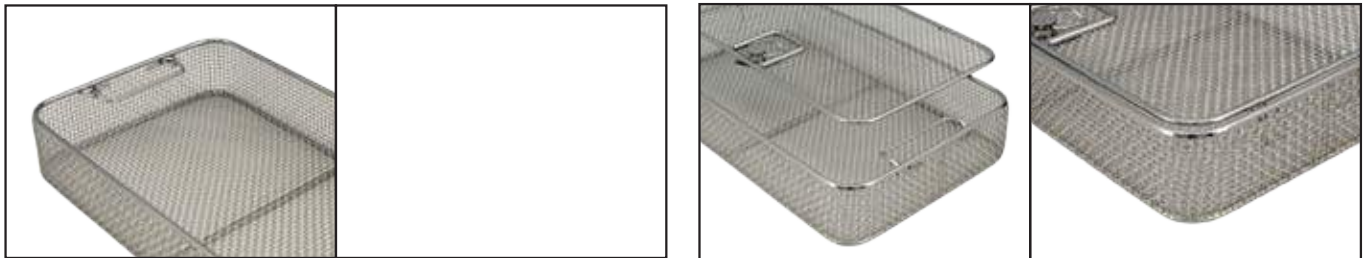

Basket Made From Stainles Steel Wire Mesh

 <table border="1" data-bbox="518 562 783 658"> <tr> <td>K2-1500</td> <td>405 x 250 x 30 mm</td> </tr> <tr> <td>K2-1501</td> <td>405 x 250 x 50 mm</td> </tr> <tr> <td>K2-1502</td> <td>405 x 250 x 70 mm</td> </tr> <tr> <td>K2-1503</td> <td>405 x 250 x 100 mm</td> </tr> </table> <p>WIRE BASKET</p>	K2-1500	405 x 250 x 30 mm	K2-1501	405 x 250 x 50 mm	K2-1502	405 x 250 x 70 mm	K2-1503	405 x 250 x 100 mm	 <table border="1" data-bbox="1177 551 1465 692"> <tr> <td>K3-1030</td> <td>405 x 250 x 30 mm</td> </tr> <tr> <td>K3-1031</td> <td>405 x 250 x 50 mm</td> </tr> <tr> <td>K3-1032</td> <td>405 x 250 x 70 mm</td> </tr> <tr> <td>K3-1033</td> <td>405 x 250 x 100 mm</td> </tr> <tr> <td>K3-1034</td> <td>ONLY LID, for baskets</td> </tr> </table> <p>WIRE BASKET WITH LID</p>	K3-1030	405 x 250 x 30 mm	K3-1031	405 x 250 x 50 mm	K3-1032	405 x 250 x 70 mm	K3-1033	405 x 250 x 100 mm	K3-1034	ONLY LID, for baskets
K2-1500	405 x 250 x 30 mm																		
K2-1501	405 x 250 x 50 mm																		
K2-1502	405 x 250 x 70 mm																		
K2-1503	405 x 250 x 100 mm																		
K3-1030	405 x 250 x 30 mm																		
K3-1031	405 x 250 x 50 mm																		
K3-1032	405 x 250 x 70 mm																		
K3-1033	405 x 250 x 100 mm																		
K3-1034	ONLY LID, for baskets																		



Wire Basket With Perforated Metal Plate

 <table border="1" data-bbox="504 1462 783 1536"> <tr> <td>K2-1501 P</td> <td>405 x 250 x 50 mm</td> </tr> <tr> <td>K2-1502 P</td> <td>405 x 250 x 70 mm</td> </tr> <tr> <td>K2-1503 P</td> <td>405 x 250 x 100 mm</td> </tr> </table> <p>WIRE BASKET</p>	K2-1501 P	405 x 250 x 50 mm	K2-1502 P	405 x 250 x 70 mm	K2-1503 P	405 x 250 x 100 mm	 <table border="1" data-bbox="1169 1431 1465 1550"> <tr> <td>K3-1031 P</td> <td>405 x 250 x 50 mm</td> </tr> <tr> <td>K3-1032 P</td> <td>405 x 250 x 70 mm</td> </tr> <tr> <td>K3-1033 P</td> <td>405 x 250 x 100 mm</td> </tr> <tr> <td>K3-1034 P</td> <td>ONLY LID, for baskets</td> </tr> </table> <p>WIRE BASKET WITH LID</p>	K3-1031 P	405 x 250 x 50 mm	K3-1032 P	405 x 250 x 70 mm	K3-1033 P	405 x 250 x 100 mm	K3-1034 P	ONLY LID, for baskets
K2-1501 P	405 x 250 x 50 mm														
K2-1502 P	405 x 250 x 70 mm														
K2-1503 P	405 x 250 x 100 mm														
K3-1031 P	405 x 250 x 50 mm														
K3-1032 P	405 x 250 x 70 mm														
K3-1033 P	405 x 250 x 100 mm														
K3-1034 P	ONLY LID, for baskets														

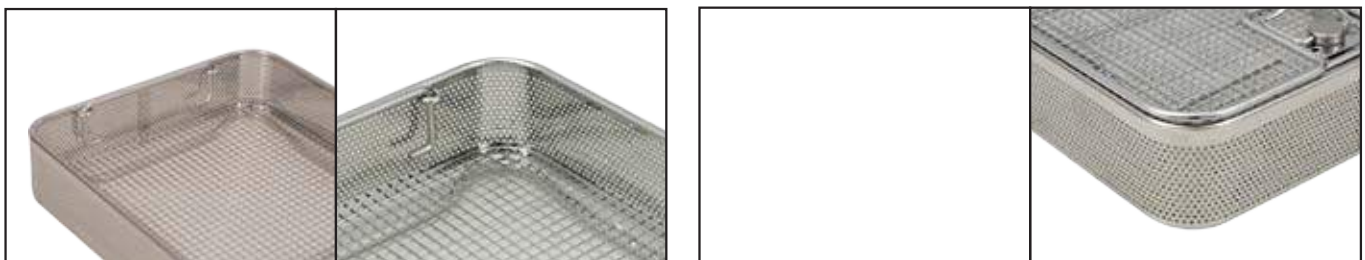

Basket Made From Stainless Steel Sheet



 Box and Lid	K3-728 405 x 253 x 30 mm
	K3-729 405 x 253 x 50 mm
	K3-730 405 x 253 x 70 mm
 Box	K3-748 405 x 253 x 30 mm
	K3-749 405 x 253 x 50 mm
	K3-750 405 x 253 x 70 mm
	K3-751 405 x 253 x 100 mm
 Lid	K3-762 405 x 253 x 10 mm



- K2-560** RED
- K2-561** BLUE
- K2-562** GREEN
- K2-563** YELLOW
- K2-564** GREY
- K2-565** BLACK

- K2-570**
- K2-571**
- K2-572**
- K2-573**
- K2-574**
- K2-575**

Coloured identification labels Engraved to your specification

Grey coloured recommended for use in Sterrad.
Color fading By effect of Hydrogen Peroxide Gas Plasma on other colors.



K2-569
Information board with clip



K2-1540 405 x 250 x 80 mm
K2-1541 405 x 250 x 110 mm
K2-1542 405 x 250 x 130 mm
 DIVIDERS



K2-1522 405 x 255 x 30 mm
 WIRE BASE



K2-1530 405 x 250 x 80 mm
K2-1531 405 x 250 x 110 mm
K2-1532 405 x 250 x 130 mm
 DIVIDERS

(-)



K2-1521 405 x 255 x 30 mm
 DRAPE RETAINER



K2-1520 405 x 255 mm
 DRAPE RETAINER



K3-1119 245 x 130 x 55 mm
 Aluminium basket, with lid



K3-1120 245 x 130 x 70 mm
 Aluminium basket, with lid



K3-1121 245 x 130 x 105 mm
 Aluminium basket, with lid



K2-524 380 x 230 mm
K2-525 440 x 230 mm
 Silicone mat



K2-531 480 x 250 x 2.0 mm
 Silicone mat



K2-700
K2-701
K2-702
K2-703
K2-704
K2-705



K2-710 Red
K2-711 Yellow
K2-712 Green
K2-713 Blue
K2-714 Grey
K2-715 Black



K2-673
 Labels, paper 100 pcs.
 With indicator.
 For small size and special containers



K2-672
 Labels, paper 100 pcs.
 With indicator.
 For full and half size containers



K2-663
 Security seal, made of plastic
 100 pcs. with indicator. (Blue)



K2-664
 Security seal, made of plastic
 100 pcs.(Blue)



K2-661
 Security seal, made of plastic
 100 pcs. with number.(Blue)



K2-662
 Security seal, made of plastic
 100 pcs. with indicator.(Red)



K2-660
 Security seal, made of plastic
 100 pcs.(Red)



K2-665
 Security seal, made of plastic
 100 pcs. with number.(Red)



K2-717 40 x 35 x 9 mm
 Disposal stamp
 Requested number or letter
 must be informed during
 the order.



K2-716 50 x 35 x 13 mm
 Holder for identification labels





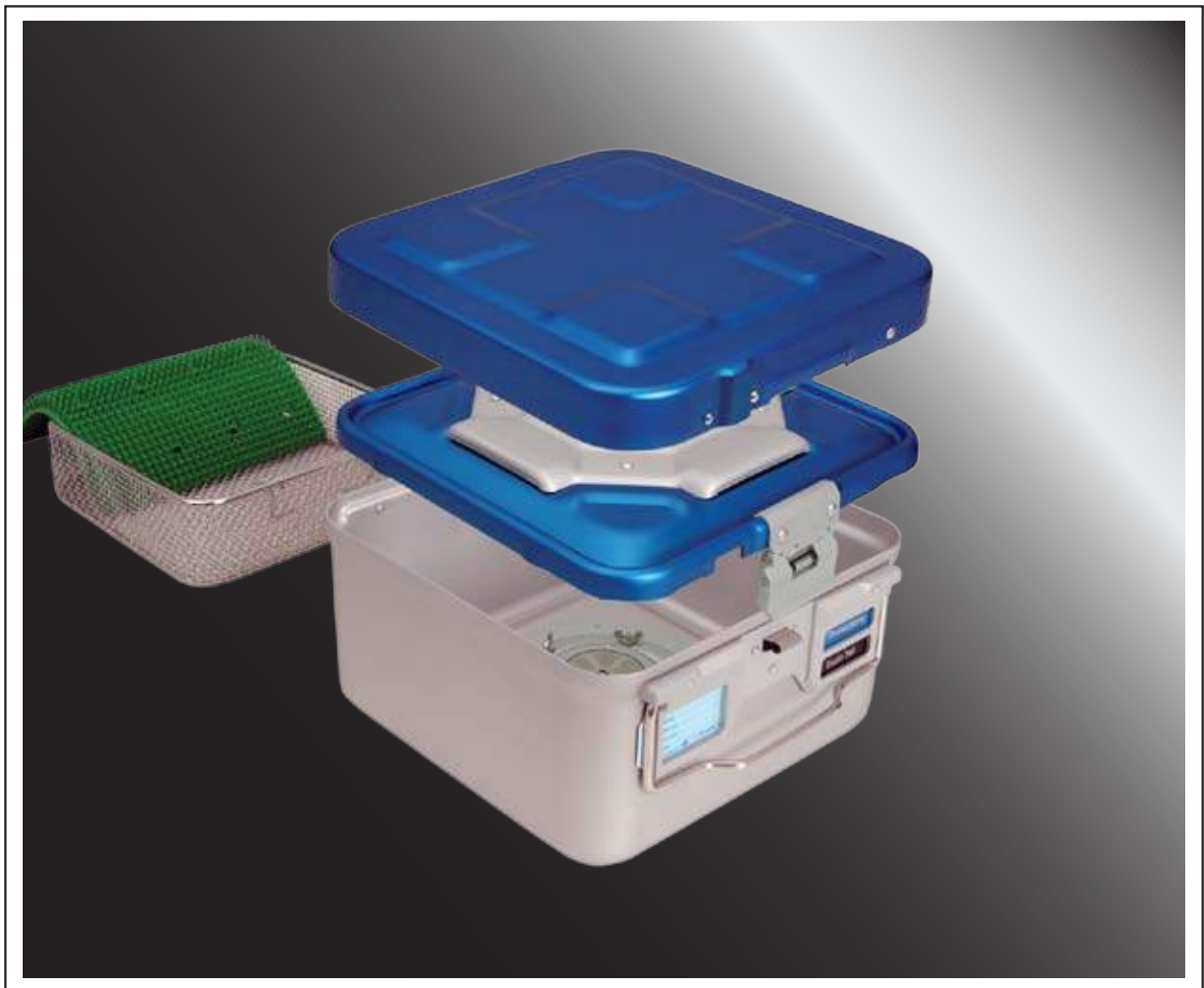





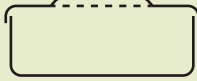
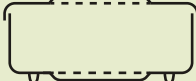

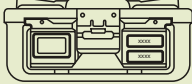

















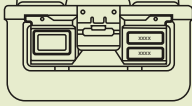























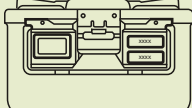























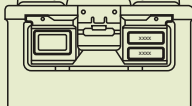















































(-)

Sterile Container System



1/2 Half Size

Bio-Barrier Model

Specifications Sizes	Lid (with barrier)  Box (Non-Perforated)	Lid (with barrier)  Box (with barrier)	Safety Lid Lid (with barrier)  Box (Non-Perforated)	Safety Lid Lid (with barrier)  Box (with barrier)
	285 X 280 X h mm 	K7-500  K7-501  K7-502  K7-503  K7-504  K7-505  h= 105 mm	K7-530  K7-531  K7-532  K7-533  K7-534  K7-535  h= 135 mm	K7-640  K7-641  K7-642  K7-643  K7-644  K7-645  h= 128 mm
285 X 280 X h mm 	K7-506  K7-507  K7-508  K7-509  K7-510  K7-511  h= 140 mm	K7-536  K7-537  K7-538  K7-539  K7-540  K7-541  h= 160 mm	K7-646  K7-647  K7-648  K7-649  K7-650  K7-651  h= 153 mm	K7-676  K7-677  K7-678  K7-679  K7-680  K7-681  h= 170 mm
285 X 280 X h mm 	K7-512  K7-513  K7-514  K7-515  K7-516  K7-517  h= 155 mm	K7-542  K7-543  K7-544  K7-545  K7-546  K7-547  h= 175 mm	K7-652  K7-653  K7-654  K7-655  K7-656  K7-657  h= 168 mm	K7-682  K7-683  K7-684  K7-685  K7-686  K7-687  h= 185 mm
285 X 280 X h mm 	K7-518  K7-519  K7-520  K7-521  K7-522  K7-523  h= 205 mm	K7-548  K7-549  K7-550  K7-551  K7-552  K7-553  h= 235 mm	K7-658  K7-659  K7-660  K7-661  K7-662  K7-663  h= 218 mm	K7-688  K7-689  K7-690  K7-691  K7-692  K7-693  h= 245 mm
285 X 280 X h mm 	K7-524  K7-525  K7-526  K7-527  K7-528  K7-529  h= 265 mm	K7-554  K7-555  K7-556  K7-557  K7-558  K7-559  h= 295 mm	K7-664  K7-665  K7-666  K7-667  K7-668  K7-669  h= 278 mm	K7-694  K7-695  K7-696  K7-697  K7-698  K7-699  h= 305 mm
Ps: All container measurements cover the outer size of the lids.				
				

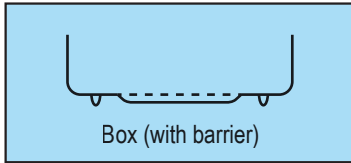

CODE	OUTSIDE	INSIDE	WEIGHT
K7-600	306 X 272 X 115 mm	253 X 258 X 90 mm	1.60 kg
K7-601	306 X 272 X 134 mm	253 X 258 X 109 mm	1.70 kg
K7-602	306 X 272 X 155 mm	253 X 258 X 130 mm	1.80 kg
K7-603	306 X 272 X 204 mm	253 X 258 X 179 mm	2.00 kg
K7-604	306 X 272 X 261 mm	253 X 258 X 236 mm	2.45 kg

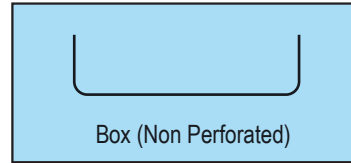

CODE	OUTSIDE	INSIDE	WEIGHT
K7-605	306 X 272 X 95 mm	253 X 258 X 90 mm	1.15 kg
K7-606	306 X 272 X 114 mm	253 X 258 X 109 mm	1.25 kg
K7-607	306 X 272 X 135 mm	253 X 258 X 130 mm	1.35 kg
K7-608	306 X 272 X 184 mm	253 X 258 X 179 mm	1.55 kg
K7-609	306 X 272 X 241 mm	253 X 258 X 236 mm	2.00 kg



Lid Barrier system

Weight: 0.97 kg

- K7-630**
- K7-631**
- K7-632**
- K7-633**
- K7-634**
- K7-635**

Safety Lids

Weight: 0.66 kg

- K7-412**
- K7-413**
- K7-414**
- K7-415**
- K7-416**
- K7-417**



Basket Made From Stainles Steel Wire Mesh



- K2-490** 255 x 250 x 30 mm
- K2-491** 255 x 250 x 50 mm
- K2-492** 255 x 250 x 70 mm
- K2-493** 255 x 250 x 100 mm

WIRE BASKET



- K3-1040** 255 x 250 x 30 mm
- K3-1041** 255 x 250 x 50 mm
- K3-1042** 255 x 250 x 70 mm
- K3-1043** 255 x 250 x 100 mm
- K3-1045** ONLY LID, for baskets

WIRE BASKET WITH LID

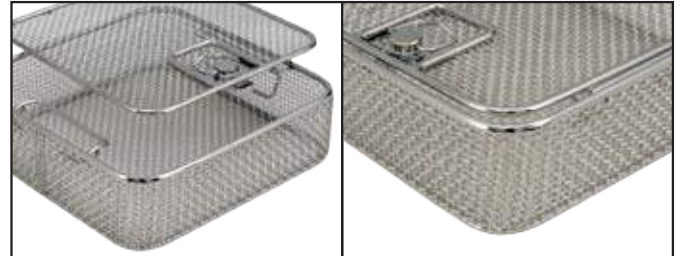
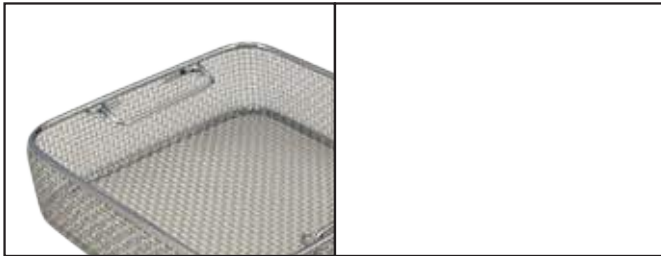

Wire Basket With Perforated Metal Plate



- K2-491 P** 255 x 250 x 50 mm
- K2-492 P** 255 x 250 x 70 mm
- K2-493 P** 255 x 250 x 100 mm

WIRE BASKET



- K3-1041 P** 255 x 250 x 50 mm
- K3-1042 P** 255 x 250 x 70 mm
- K3-1043 P** 255 x 250 x 100 mm
- K3-1045 P** ONLY LID, for baskets

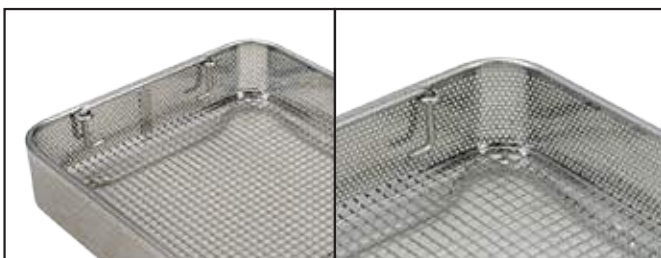

WIRE BASKET WITH LID

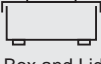
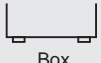
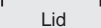

Basket Made From Stainless Steel Sheet

 <p>BASKET</p>	 <p>Box and Lid</p>	<p>K3-732 244 x 253 x 30 mm K3-733 244 x 253 x 50 mm K3-734 244 x 253 x 70 mm K3-735 244 x 253 x 100 mm</p>
	 <p>Box</p>	<p>K3-752 244 x 253 x 30 mm K3-753 244 x 253 x 50 mm K3-754 244 x 253 x 70 mm K3-755 244 x 253 x 100 mm</p>
	 <p>Lid</p>	<p>K3-763 244 x 253 x 10 mm</p>



 <p>K2-560 RED K2-561 BLUE K2-562 GREEN K2-563 YELLOW K2-564 GREY K2-565 BLACK</p>	 <p>K2-570 K2-571 K2-572 K2-573 K2-574 K2-575</p> <p>Coloured identification labels Engraved to your specification</p>
--	--

Grey coloured recommended for use in Sterrad.
 Color fading By effect of Hydrogen Peroxide Gas Plasma on other colors.



K2-569
Information board with clip

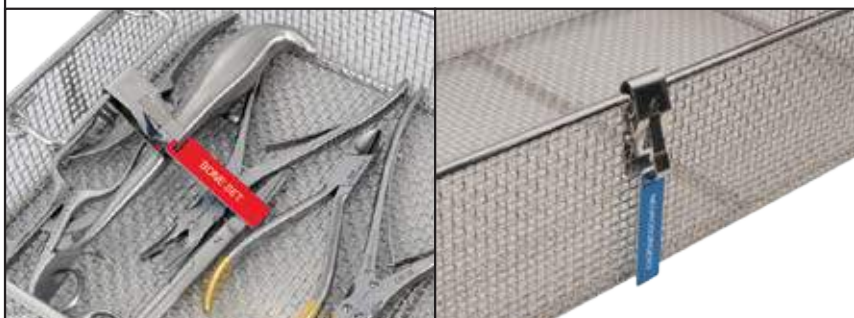

K2-483 255 x 245 x 130 mm
K2-484 255 x 245x 180 mm
DIVIDERS



K2-482 255 x 255 x 30 mm
WIRE BASE

(-)



K3-1094
Rack for kerrison
Holds 10 kerrison punches
Fits into a 1/2 and 1/1 size
20 cm deep container

Wire basket 1/2 50 mm
Wire basket 1/1 50 mm
Container 1/2 200 mm
Container 1/2 200 mm



K3-481 255 x 255 x 30 mm
DRAPE RETAINER



K2-480 255 x 255 mm
DRAPE RETAINER



K3-1119 245 x 130 x 55 mm
Aluminium basket, with lid



K3-1120 245 x 130 x 70 mm
Aluminium basket, with lid



K3-1121 245 x 130 x 105 mm
Aluminium basket, with lid



K2-521 255 x 255 mm
Silicone mat

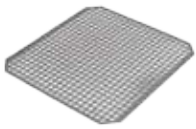

K2-531 480 x 250 x 2.0 mm
Silicone mat



K2-700 Red
K2-701 Blue
K2-702 Green
K2-703 Yellow
K2-704 Grey
K2-705 Black



K2-710 Red
K2-711 Yellow
K2-712 Green
K2-713 Blue
K2-714 Grey
K2-715 Black



K2-673
Labels, paper 100 pcs.
With indicator.

For small size and special
containers



K2-672
Labels, paper 100 pcs.
With indicator.

For full and half size containers



K2-663
Security seal, made of plastic
100 pcs. with indicator. (Blue)



K2-664
Security seal, made of plastic
100 pcs.(Blue)



K2-661
Security seal, made of plastic
100 pcs. with number.(Blue)



K2-662
Security seal, made of plastic
100 pcs. with indicator.(Red)



K2-660
Security seal, made of
plastic 100 pcs.(Red)



K2-665
Security seal, made of plastic
100 pcs. with number.(Red)



K2-717 40 x 35 x 9 mm
Disposal stamp
Requested number or letter
must be informed during
the order.



K2-716 50 x 35 x 13 mm
Holder for identification labels













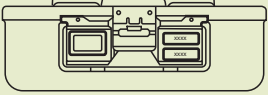















(-)

Sterile Container System



XL Size

Bio-Barrier Model

<p>Specifications</p> <p>Sizes</p>	<p>Lid (with barrier)</p>  <p>Box (Non-Perforated)</p>	<p>Lid (with barrier)</p>  <p>Box (with barrier)</p>
<p>590 X 370 X h mm</p> 	<p>K7-711 </p> <p>K7-712 </p> <p>K7-713 </p> <p>K7-714 </p> <p>K7-715 </p> <p>K7-716 </p> <p style="text-align: center;">h = 125 mm</p>	<p>K7-741 </p> <p>K7-742 </p> <p>K7-743 </p> <p>K7-744 </p> <p>K7-745 </p> <p>K7-746 </p> <p style="text-align: center;">h = 135 mm</p>
<p>590 X 370 X h mm</p> 	<p>K7-717 </p> <p>K7-718 </p> <p>K7-719 </p> <p>K7-720 </p> <p>K7-721 </p> <p>K7-722 </p> <p style="text-align: center;">h = 185 mm</p>	<p>K7-747 </p> <p>K7-748 </p> <p>K7-749 </p> <p>K7-750 </p> <p>K7-751 </p> <p>K7-752 </p> <p style="text-align: center;">h = 195 mm</p>
<p>Ps: All container measurements cover the outer size of the lids.</p>		

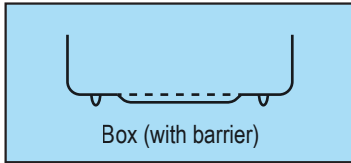

CODE	OUTSIDE	INSIDE	WEIGHT
K7-700	595 X 365 X 125 mm	530 X 350 X 100 mm	2.620 kg
K7-701	595 X 365 X 187 mm	530 X 350 X 162 mm	3.440 kg

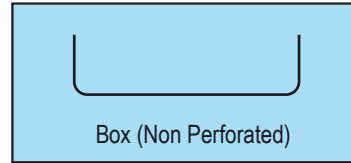

CODE	OUTSIDE	INSIDE	WEIGHT
K7-702	595 X 365 X 105 mm	530 X 350 X 100 mm	2.20 kg
K7-703	595 X 365 X 167 mm	530 X 350 X 167 mm	3.00 kg



Lid Barrier system

Weight: 2.037 kg







K7-771	
K7-772	
K7-773	
K7-774	
K7-775	
K7-776	

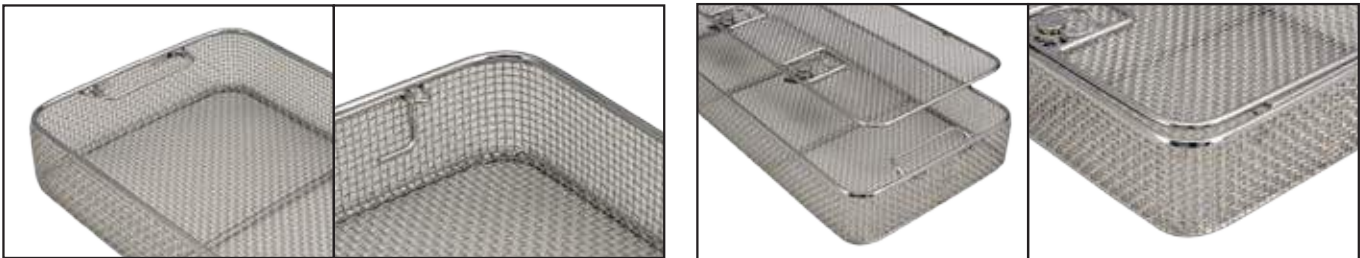

Basket Made From Stainles Steel Wire Mesh

	K2-1701 533 x 337 x 50 mm K2-1702 533 x 337 x 75 mm K2-1703 533 x 337 x 100 mm		K3-1704 533 x 337 x 50 mm K3-1705 533 x 337 x 75 mm K3-1706 533 x 337 x 100 mm
			K3-1707 ONLY LID, for baskets
	<p>WIRE BASKET</p>		<p>WIRE BASKET WITH LID</p>





















 <ul style="list-style-type: none"> K2-560 RED K2-561 BLUE K2-562 GREEN K2-563 YELLOW K2-564 GREY K2-565 BLACK 	 <ul style="list-style-type: none"> K2-570 K2-571 K2-572 K2-573 K2-574 K2-575 <p>Coloured identification labels Engraved to your specification</p>	 <p>K2-569 Information board with clip</p>
<p>Grey coloured recommended for use in Sterrad. Color fading By effect of Hydrogen Peroxide Gas Plasma on other colors.</p>		
		

XL Accessories



Sterile Container Systems

 <p>K2-1731 533 x 337 x 70 mm K2-1732 533 x 337 x 120 mm DIVIDERS</p>	<p>(-)</p>	 <p>K2-1721 533 x 337 x 70 mm K2-1722 533 x 337 x 120 mm DIVIDERS</p>
<p>(-)</p>	 <p>K2-1712 533 x 337 x 30 mm DRAPE RETAINER</p>	 <p>K2-1711 533 x 337 mm DRAPE RETAINER</p>
<p>(-)</p>	<p>(-)</p>	 <ul style="list-style-type: none"> ● K2-700 ● K2-701 ● K2-702 ● K2-703 ● K2-704 ● K2-705
 <p>K3-1119 245 x 130 x 55 mm Aluminium basket, with lid</p>	 <p>K3-1120 245 x 130 x 70 mm Aluminium basket, with lid</p>	 <p>K3-1121 245 x 130 x 105 mm Aluminium basket, with lid</p>
 <ul style="list-style-type: none"> K2-710 Red K2-711 Yellow K2-712 Green K2-713 Blue K2-714 Grey K2-715 Black 	 <p>K2-673 Labels, paper 100 pcs. With indicator. For small size and special containers</p>	 <p>K2-672 Labels, paper 100 pcs. With indicator. For full and half size containers</p>
 <p>K2-663 Security seal, made of plastic 100 pcs. with indicator. (Blue)</p>	 <p>K2-664 Security seal, made of plastic 100 pcs. (Blue)</p>	 <p>K2-661 Security seal, made of plastic 100 pcs. with number. (Blue)</p>
 <p>K2-662 Security seal, made of plastic 100 pcs. with indicator. (Red)</p>	 <p>K2-660 Security seal, made of plastic 100 pcs. (Red)</p>	 <p>K2-665 Security seal, made of plastic 100 pcs. with number. (Red)</p>
 <p>K2-717 40 x 35 x 9 mm Disposal stamp Requested number or letter must be informed during the order.</p>	 <p>K2-716 50 x 35 x 13 mm Holder for identification labels</p>	<p>(-)</p>

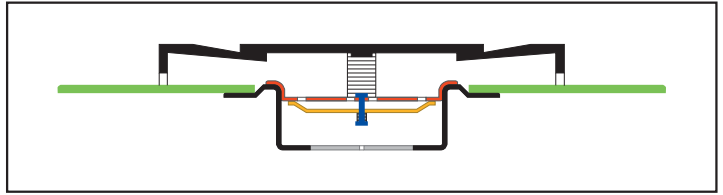

1. Before sterilization the valves are in relax position

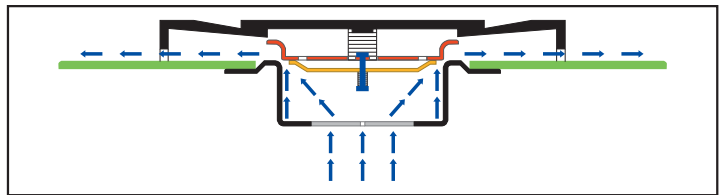

2. During the sterilization by effect of vacuum the valves are opened completely and the dry air goes out of the container.

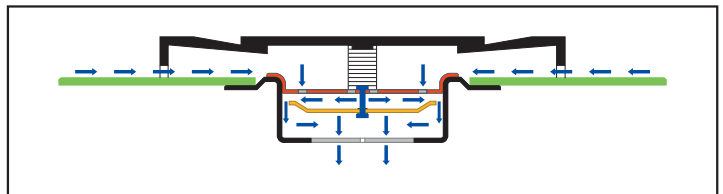

3. At the end the sterilization cycle the valves are opened in the reverse way by effect of vacuum and the sterilization cycle is completed.

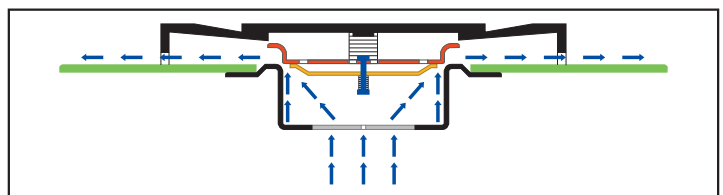

4. At the end of the sterilization cycle the sterilizer equates the pressure level and the valves of the Barrier Model Container are closed.

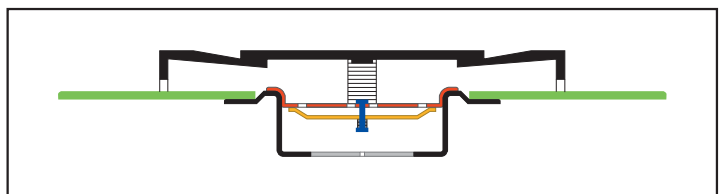

5. After sterilization the valves are in relax position.











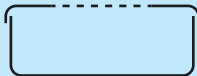

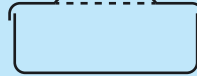
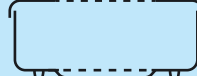







































































































































Sterile Container System



1/1 Full Size

High Performance Polymers PPSU Lids

Edition 6

Specifications	Lid (perforated)	Lid (Perforated)	Lid (with barrier)	Lid (with barrier)
	 Box (Non-Perforated)	 Box (Perforated)	 Box (Non-Perforated)	 Box (with barrier)
580 X 280 X h mm 	KP6-010  KP6-011  KP6-012  KP6-013  KP6-014  KP6-015  KT6-010  Transparent	KP6-040  KP6-041  KP6-042  KP6-043  KP6-044  KP6-045  KT6-040  Transparent	KP7-010  KP7-011  KP7-012  KP7-013  KP7-014  KP7-015  KT7-010  Transparent	KP7-040  KP7-041  KP7-042  KP7-043  KP7-044  KP7-045  KT7-040  Transparent
580 X 280 X h mm 	KP6-016  KP6-017  KP6-018  KP6-019  KP6-020  KP6-021  KT6-016  Transparent	KP6-046  KP6-047  KP6-048  KP6-049  KP6-050  KP6-051  KT6-046  Transparent	KP7-016  KP7-017  KP7-018  KP7-019  KP7-020  KP7-021  KT7-016  Transparent	KP7-046  KP7-047  KP7-048  KP7-049  KP7-050  KP7-051  KT7-046  Transparent
580 X 280 X h mm 	KP6-022  KP6-023  KP6-024  KP6-025  KP6-026  KP6-027  KT6-022  Transparent	KP6-052  KP6-053  KP6-054  KP6-055  KP6-056  KP6-057  KT6-052  Transparent	KP7-022  KP7-023  KP7-024  KP7-025  KP7-026  KP7-027  KT7-022  Transparent	KP7-052  KP7-053  KP7-054  KP7-055  KP7-056  KP7-057  KT7-052  Transparent
580 X 280 X h mm 	KP6-028  KP6-029  KP6-030  KP6-031  KP6-032  KP6-033  KT6-028  Transparent	KP6-058  KP6-059  KP6-060  KP6-061  KP6-062  KP6-063  KT6-058  Transparent	KP7-028  KP7-029  KP7-030  KP7-031  KP7-032  KP7-033  KT7-028  Transparent	KP7-058  KP7-059  KP7-060  KP7-061  KP7-062  KP7-063  KT7-058  Transparent
580 X 280 X h mm 	KP6-034  KP6-035  KP6-036  KP6-037  KP6-038  KP6-039  KT6-034  Transparent	KP6-064  KP6-065  KP6-066  KP6-067  KP6-068  KP6-069  KT6-064  Transparent	KP7-034  KP7-035  KP7-036  KP7-037  KP7-038  KP7-039  KT7-034  Transparent	KP7-064  KP7-065  KP7-066  KP7-067  KP7-068  KP7-069  KT7-064  Transparent

Ps: All container measurements cover the outer size of the lids.



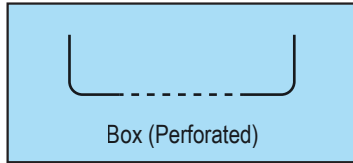

CODE	OUTSIDE	INSIDE	WEIGHT
K6-100	595 X 275 X 95 mm	543 X 260 X 75 mm	2.15 kg
K6-101	595 X 275 X 116 mm	543 X 260 X 96 mm	2.30 kg
K6-102	595 X 275 X 135 mm	543 X 260 X 115 mm	2.40 kg
K6-103	595 X 275 X 185 mm	543 X 260 X 165 mm	2.75 kg
K6-104	595 X 275 X 243 mm	543 X 260 X 223 mm	3.25 kg

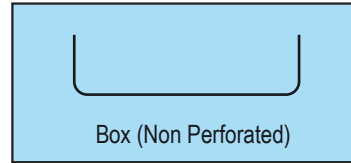

CODE	OUTSIDE	INSIDE	WEIGHT
K6-105	595 X 275 X 95 mm	543 X 260 X 90 mm	1.70 kg
K6-106	595 X 275 X 116 mm	543 X 260 X 111 mm	2.05 kg
K6-107	595 X 275 X 135 mm	543 X 260 X 130 mm	2.15 kg
K6-108	595 X 275 X 185 mm	543 X 260 X 180 mm	2.60 kg
K6-109	595 X 275 X 243 mm	543 X 260 X 238 mm	3.10 kg



Perforated Lids

Weight: 1.360 kg

- KP6-120**
- KP6-121**
- KP6-122**
- KP6-123**
- KP6-124**
- KP6-125**
- KT6-120**

Safety Lids (For perforated Lids)

Weight: 1.110 kg

- KP6-230**
- KP6-231**
- KP6-232**
- KP6-233**
- KP6-234**
- KP6-235**
- KT6-230**

Bio Barrier Lids

Weight: 1.900 kg

- KP7-120**
- KP7-121**
- KP7-122**
- KP7-123**
- KP7-124**
- KP7-125**
- KT7-120**



Safety Lid (For Bio Barrier Lids)

Weight: 1.260 kg

- KP7-400**
- KP7-401**
- KP7-402**
- KP7-403**
- KP7-404**
- KP7-405**
- KT7-400**



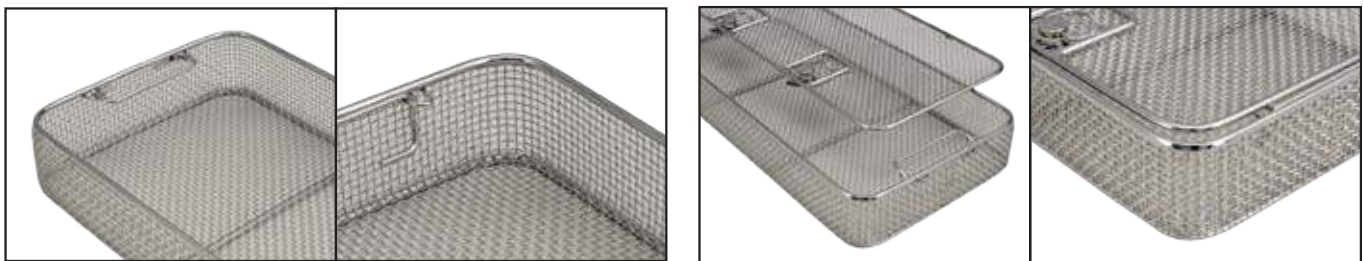

Basket Made From Stainles Steel Wire Mesh

 <p>WIRE BASKET</p>	<p>K2-460 540 x 250 x 30 mm</p> <p>K2-461 540 x 250 x 50 mm</p> <p>K2-462 540 x 250 x 70 mm</p> <p>K2-463 540 x 250 x 100 mm</p>	 <p>WIRE BASKET WITH LID</p>	<p>K3-1010 540 x 250 x 30 mm</p> <p>K3-1011 540 x 250 x 50 mm</p> <p>K3-1012 540 x 250 x 70 mm</p> <p>K3-1013 540 x 250 x 100 mm</p>
	<p>K2-450 480 x 250 x 30 mm</p> <p>K2-451 480 x 250 x 50 mm</p> <p>K2-452 480 x 250 x 70 mm</p> <p>K2-453 480 x 250 x 100 mm</p>		<p>K3-1014 ONLY LID, for baskets</p> <p>K3-1020 480 x 250 x 30 mm</p> <p>K3-1021 480 x 250 x 50 mm</p> <p>K3-1022 480 x 250 x 70 mm</p> <p>K3-1023 480 x 250 x 100 mm</p>
		<p>K3-1024 ONLY LID, for baskets</p>	



Wire Basket With Perforated Metal Plate

 <p>WIRE BASKET</p>	<p>K2-461 P 540 x 250 x 50 mm</p> <p>K2-462 P 540 x 250 x 70 mm</p> <p>K2-463 P 540 x 250 x 100 mm</p>	 <p>WIRE BASKET WITH LID</p>	<p>K3-1011 P 540 x 250 x 50 mm</p> <p>K3-1012 P 540 x 250 x 70 mm</p> <p>K3-1013 P 540 x 250 x 100 mm</p>
	<p>K2-451 P 480 x 250 x 50 mm</p> <p>K2-452 P 480 x 250 x 70 mm</p> <p>K2-453 P 480 x 250 x 100 mm</p>		<p>K3-1014 P ONLY LID, for baskets</p> <p>K3-1021 P 480 x 250 x 50 mm</p> <p>K3-1022 P 480 x 250 x 70 mm</p> <p>K3-1023 P 480 x 250 x 100 mm</p>
		<p>K3-1024 P ONLY LID, for baskets</p>	

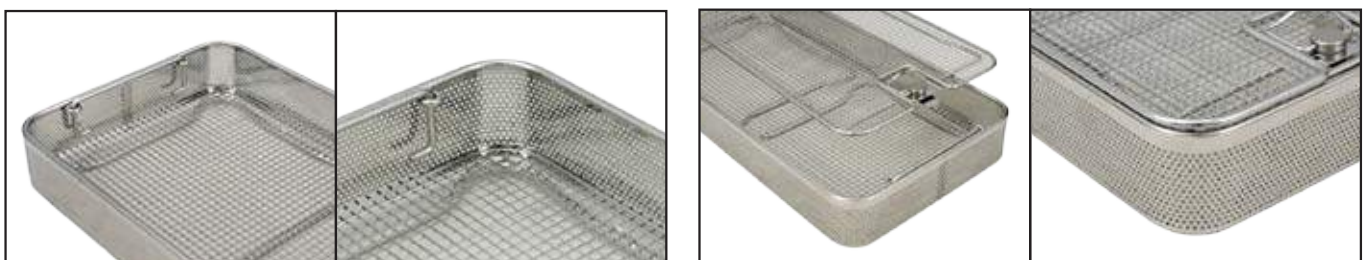

Basket Made From Stainles Steel Sheet

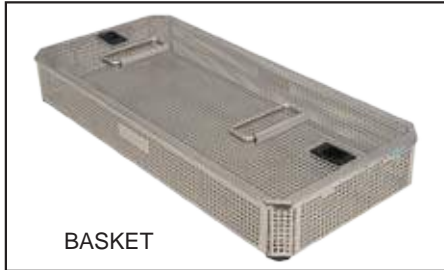

BASKET

	K3-720 540 x 253 x 30 mm
	K3-721 540 x 253 x 50 mm
	K3-722 540 x 253 x 70 mm
	K3-723 540 x 253 x 100 mm
	K3-740 540 x 253 x 30 mm
	K3-741 540 x 253 x 50 mm
	K3-742 540 x 253 x 70 mm
	K3-743 540 x 253 x 100 mm
	K3-760 540 x 253 x 10 mm



K3-767
Stand
Height 20 mm



BASKET

	K3-724 485 x 253 x 30 mm
	K3-725 485 x 253 x 50 mm
	K3-726 485 x 253 x 70 mm
	K3-727 485 x 253 x 100 mm
	K3-744 485 x 253 x 30 mm
	K3-745 485 x 253 x 50 mm
	K3-746 485 x 253 x 70 mm
	K3-747 485 x 253 x 100 mm
	K3-761 540 x 253 x 10 mm



K3-768
Stand
Height 14 mm



- K2-560** RED
- K2-561** BLUE
- K2-562** GREEN
- K2-563** YELLOW
- K2-564** GREY
- K2-565** BLACK

- K2-570**
- K2-571**
- K2-572**
- K2-573**
- K2-574**
- K2-575**

Coloured identification labels Engraved to your specification

Grey coloured recommended for use in Sterrad.
Color fading By effect of Hydrogen Peroxide Gas Plasma on other colors.

K2-569
Information board with clip

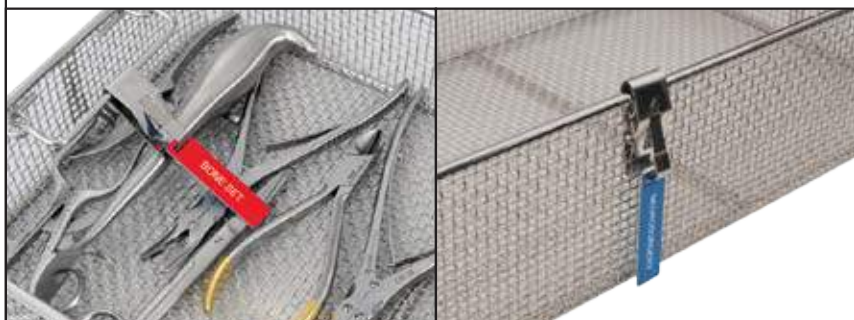



K2-428 540 x 250 x 130 mm
K2-429 540 x 250 x 180 mm
DIVIDERS



K2-440 545 x 255 x 30 mm
WIRE BASE



K2-425 540 x 250 x 130 mm
K2-426 540 x 250 x 180 mm
DIVIDERS

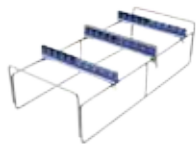

K3-1090
Rack for endoscopy
Holds 10 endoscopic instruments
Fits into a 1/1 size 20 cm deep container

Wire basket 1/1 50 mm
Container 1/1 200 mm
Silicone mat 520 x 230 mm



K2-420 545 x 255 x 30 mm
DRAPE RETAINER



K2-400 545 x 255 mm
DRAPE RETAINER



K3-1119 245 x 130 x 55 mm
Aluminium basket, with lid



K3-1120 245 x 130 x 70 mm
Aluminium basket, with lid



K3-1121 245 x 130 x 105 mm
Aluminium basket, with lid



K2-526 520 x 230 mm
K2-528 470 x 230 mm
Silicone mat



K2-531 480 x 250 x 2.0 mm
Silicone mat

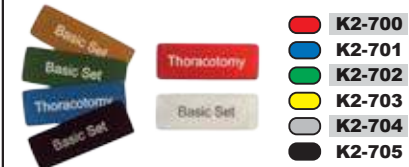

K2-700
K2-701
K2-702
K2-703
K2-704
K2-705



K2-740
Single use paper filter 100 pcs with indicator



K2-742
Teflon filter
Number of sterilization cycle > 1200



K2-730
Filter Dispenser



K2-710 Red
K2-711 Yellow
K2-712 Green
K2-713 Blue
K2-714 Grey
K2-715 Black



K2-673
Labels, paper 100 pcs. With indicator.

For small size and special containers



K2-672
Labels, paper 100 pcs. With indicator.

For full and half size containers



K2-663
Security seal, made of plastic 100 pcs. with indicator. (Blue)



K2-664
Security seal, made of plastic 100 pcs. (Blue)



K2-661
Security seal, made of plastic 100 pcs. with number. (Blue)



K2-662
Security seal, made of plastic 100 pcs. with indicator. (Red)



K2-660
Security seal, made of plastic 100 pcs. (Red)



K2-665
Security seal, made of plastic 100 pcs. with number. (Red)



K2-717 40 x 35 x 9 mm
Disposal stamp
Requested number or letter must be informed during the order.

































































































K2-716 50 x 35 x 13 mm
Holder for identification labels

(-)

Sterile Container System



3/4 Quarter Size **High Performance Polymers PPSU Lids**

Specifications	Lid (perforated)	Lid (Perforated)	Lid (with barrier)	Lid (with barrier)
	Box (Non-Perforated)	Box (Perforated)	Box (Non-Perforated)	Box (with barrier)
<p>465 X 280 X h mm</p> 	<p> KP6-240  KP6-241  KP6-242  KP6-243  KP6-244  KP6-245  KT6-240  Transparent </p> <p style="text-align: center;">h = 100 mm</p>	<p> KP6-260  KP6-261  KP6-262  KP6-263  KP6-264  KP6-265  KT6-260  Transparent </p> <p style="text-align: center;">h = 100 mm</p>	<p> KP7-240  KP7-241  KP7-242  KP7-243  KP7-244  KP7-245  KT7-240  Transparent </p> <p style="text-align: center;">h = 115 mm</p>	<p> KP7-260  KP7-261  KP7-262  KP7-263  KP7-264  KP7-265  KT7-260  Transparent </p> <p style="text-align: center;">h = 135 mm</p>
<p>465 X 280 X h mm</p> 	<p> KP6-246  KP6-247  KP6-248  KP6-249  KP6-250  KP6-251  KT6-246  Transparent </p> <p style="text-align: center;">h = 130 mm</p>	<p> KP6-266  KP6-267  KP6-268  KP6-269  KP6-270  KP6-271  KT6-266  Transparent </p> <p style="text-align: center;">h = 130 mm</p>	<p> KP7-246  KP7-247  KP7-248  KP7-249  KP7-250  KP7-251  KT7-246  Transparent </p> <p style="text-align: center;">h = 140 mm</p>	<p> KP7-266  KP7-267  KP7-268  KP7-269  KP7-270  KP7-271  KT7-266  Transparent </p> <p style="text-align: center;">h = 160 mm</p>
<p>465 X 280 X h mm</p> 	<p> KP6-252  KP6-253  KP6-254  KP6-255  KP6-256  KP6-257  KT6-252  Transparent </p> <p style="text-align: center;">h = 150 mm</p>	<p> KP6-272  KP6-273  KP6-274  KP6-275  KP6-276  KP6-277  KT6-272  Transparent </p> <p style="text-align: center;">h = 150 mm</p>	<p> KP7-252  KP7-253  KP7-254  KP7-255  KP7-256  KP7-257  KT7-252  Transparent </p> <p style="text-align: center;">h = 155 mm</p>	<p> KP7-272  KP7-273  KP7-274  KP7-275  KP7-276  KP7-277  KT7-272  Transparent </p> <p style="text-align: center;">h = 175 mm</p>
<p>Ps: All container measurements cover the outer size of the lids.</p>				
				

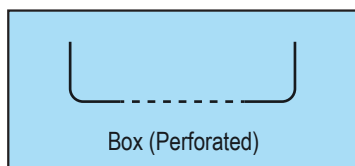

CODE	OUTSIDE	INSIDE	WEIGHT
K6-300	475 X 275 X 95 mm	422 X 260 X 90 mm	1.65 kg
K6-301	475 X 275 X 116 mm	422 X 260 X 96 mm	1.80 kg
K6-302	475 X 275 X 137 mm	422 X 260 X 117 mm	1.95 kg

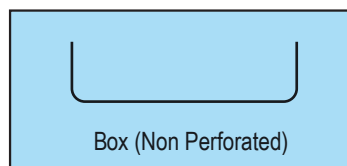

CODE	OUTSIDE	INSIDE	WEIGHT
K6-305	475 X 275 X 95 mm	422 X 260 X 90 mm	1.50 kg
K6-306	475 X 275 X 116 mm	422 X 260 X 111 mm	1.65 kg
K6-307	475 X 275 X 137 mm	422 X 260 X 132 mm	1.75 kg



Perforated Lids



Weight: 0.88 kg

- KP6-340**
- KP6-341**
- KP6-342**
- KP6-343**
- KP6-344**
- KP6-345**
- KT6-340**

Safety Lids (For perforated Lids)



Weight: 0.83 kg

- KP6-410**
- KP6-411**
- KP6-412**
- KP6-413**
- KP6-414**
- KP6-415**
- KT6-410**

Bio Barrier Lids

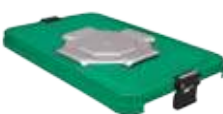

Weight: 1.19 kg

- KP7-340**
- KP7-341**
- KP7-342**
- KP7-343**
- KP7-344**
- KP7-345**
- KT7-340**

Safety Lid (For Bio Barrier Lids)





Weight: 0.87 kg

- KP7-406**
- KP7-407**
- KP7-408**
- KP7-409**
- KP7-410**
- KP7-411**
- KT7-406**



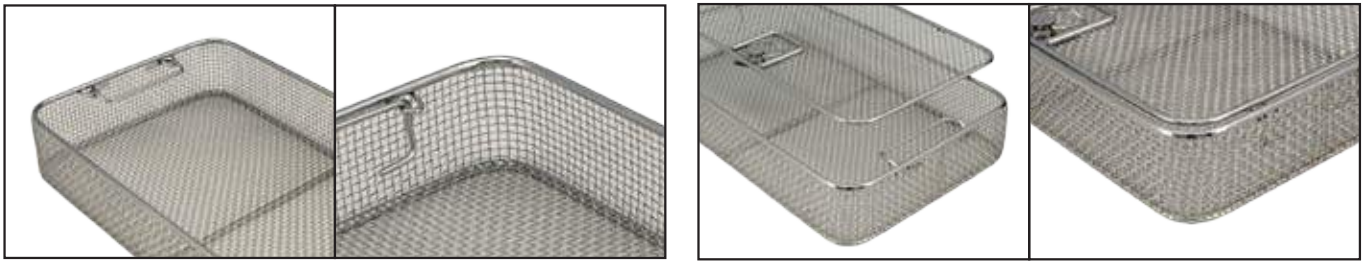

Basket Made From Stainles Steel Wire Mesh

 <table border="1" data-bbox="518 560 782 660"> <tr> <td>K2-1500</td> <td>405 x 250 x 30 mm</td> </tr> <tr> <td>K2-1501</td> <td>405 x 250 x 50 mm</td> </tr> <tr> <td>K2-1502</td> <td>405 x 250 x 70 mm</td> </tr> <tr> <td>K2-1503</td> <td>405 x 250 x 100 mm</td> </tr> </table> <p>WIRE BASKET</p>	K2-1500	405 x 250 x 30 mm	K2-1501	405 x 250 x 50 mm	K2-1502	405 x 250 x 70 mm	K2-1503	405 x 250 x 100 mm	 <table border="1" data-bbox="1173 548 1460 694"> <tr> <td>K3-1030</td> <td>405 x 250 x 30 mm</td> </tr> <tr> <td>K3-1031</td> <td>405 x 250 x 50 mm</td> </tr> <tr> <td>K3-1032</td> <td>405 x 250 x 70 mm</td> </tr> <tr> <td>K3-1033</td> <td>405 x 250 x 100 mm</td> </tr> <tr> <td>K3-1034</td> <td>ONLY LID, for baskets</td> </tr> </table> <p>WIRE BASKET WITH LID</p>	K3-1030	405 x 250 x 30 mm	K3-1031	405 x 250 x 50 mm	K3-1032	405 x 250 x 70 mm	K3-1033	405 x 250 x 100 mm	K3-1034	ONLY LID, for baskets
K2-1500	405 x 250 x 30 mm																		
K2-1501	405 x 250 x 50 mm																		
K2-1502	405 x 250 x 70 mm																		
K2-1503	405 x 250 x 100 mm																		
K3-1030	405 x 250 x 30 mm																		
K3-1031	405 x 250 x 50 mm																		
K3-1032	405 x 250 x 70 mm																		
K3-1033	405 x 250 x 100 mm																		
K3-1034	ONLY LID, for baskets																		



Wire Basket With Perforated Metal Plate

 <table border="1" data-bbox="502 1456 782 1534"> <tr> <td>K2-1501 P</td> <td>405 x 250 x 50 mm</td> </tr> <tr> <td>K2-1502 P</td> <td>405 x 250 x 70 mm</td> </tr> <tr> <td>K2-1503 P</td> <td>405 x 250 x 100 mm</td> </tr> </table> <p>WIRE BASKET</p>	K2-1501 P	405 x 250 x 50 mm	K2-1502 P	405 x 250 x 70 mm	K2-1503 P	405 x 250 x 100 mm	 <table border="1" data-bbox="1165 1422 1460 1545"> <tr> <td>K3-1031 P</td> <td>405 x 250 x 50 mm</td> </tr> <tr> <td>K3-1032 P</td> <td>405 x 250 x 70 mm</td> </tr> <tr> <td>K3-1033 P</td> <td>405 x 250 x 100 mm</td> </tr> <tr> <td>K3-1034 P</td> <td>ONLY LID, for baskets</td> </tr> </table> <p>WIRE BASKET WITH LID</p>	K3-1031 P	405 x 250 x 50 mm	K3-1032 P	405 x 250 x 70 mm	K3-1033 P	405 x 250 x 100 mm	K3-1034 P	ONLY LID, for baskets
K2-1501 P	405 x 250 x 50 mm														
K2-1502 P	405 x 250 x 70 mm														
K2-1503 P	405 x 250 x 100 mm														
K3-1031 P	405 x 250 x 50 mm														
K3-1032 P	405 x 250 x 70 mm														
K3-1033 P	405 x 250 x 100 mm														
K3-1034 P	ONLY LID, for baskets														

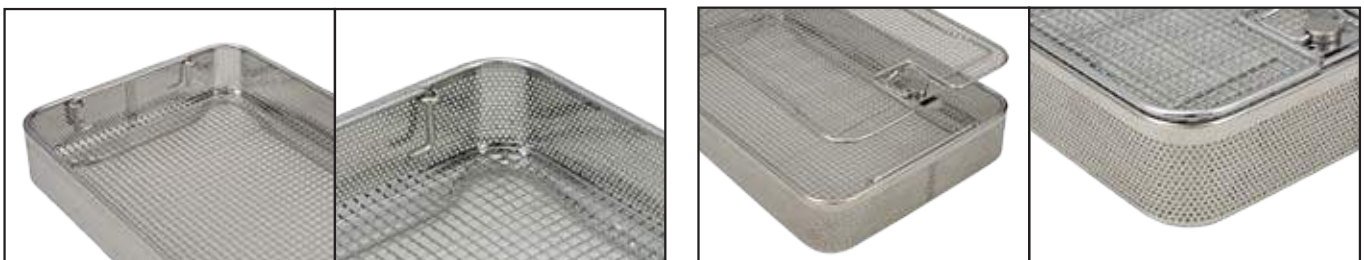

Basket Made From Stainless Steel Sheet



 Box and Lid	K3-728 405 x 253 x 30 mm
	K3-729 405 x 253 x 50 mm
	K3-730 405 x 253 x 70 mm
	K3-731 405 x 253 x 100 mm
 Box	K3-748 405 x 253 x 30 mm
	K3-749 405 x 253 x 50 mm
	K3-750 405 x 253 x 70 mm
	K3-751 405 x 253 x 100 mm
	K3-762 405 x 253 x 10 mm
 Lid	



- K2-560** RED
- K2-561** BLUE
- K2-562** GREEN
- K2-563** YELLOW
- K2-564** GREY
- K2-565** BLACK

- K2-570**
- K2-571**
- K2-572**
- K2-573**
- K2-574**
- K2-575**

Coloured identification labels Engraved to your specification

Grey coloured recommended for use in Sterrad.
Color fading By effect of Hydrogen Peroxide Gas Plasma on other colors.

K2-569
Information board with clip

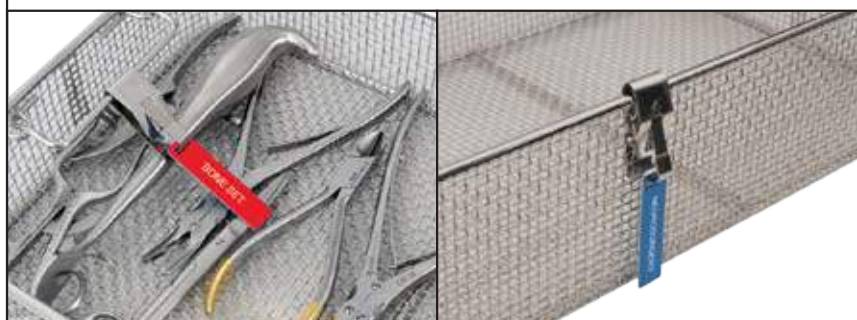



K2-1540 405 x 250 x 80 mm
K2-1541 405 x 250 x 110 mm
K2-1542 405 x 250 x 130 mm
 DIVIDERS



K2-1522 405 x 255 x 30 mm
 WIRE BASE



K2-1530 405 x 250 x 80 mm
K2-1531 405 x 250 x 110 mm
K2-1532 405 x 250 x 130 mm
 DIVIDERS

(-)



K2-1521 405 x 255 x 30 mm
 DRAPE RETAINER



K2-1520 405 x 255 mm
 DRAPE RETAINER



K3-1119 245 x 130 x 55 mm
 Aluminium basket, with lid



K3-1120 245 x 130 x 70 mm
 Aluminium basket, with lid



K3-1121 245 x 130 x 105 mm
 Aluminium basket, with lid



K2-524 380 x 230 mm
K2-525 440 x 230 mm
 Silicone mat



K2-531 480 x 250 x 2.0 mm
 Silicone mat



K2-700
K2-701
K2-702
K2-703
K2-704
K2-705



K2-740
 Single use paper filter 100 pcs with indicator



K2-742
 Teflon filter
 Number of sterilization cycle > 1200



K2-730
 Filter Dispenser



K2-710 Red
K2-711 Yellow
K2-712 Green
K2-713 Blue
K2-714 Grey
K2-715 Black



K2-673
 Labels, paper 100 pcs.
 With indicator.
 For small size and special containers



K2-672
 Labels, paper 100 pcs.
 With indicator.
 For full and half size containers



K2-663
 Security seal, made of plastic 100 pcs. with indicator. (Blue)



K2-664
 Security seal, made of plastic 100 pcs.(Blue)



K2-661
 Security seal, made of plastic 100 pcs. with number.(Blue)



K2-662
 Security seal, made of plastic 100 pcs. with indicator.(Red)



K2-660
 Security seal, made of plastic 100 pcs.(Red)



K2-665
 Security seal, made of plastic 100 pcs. with number.(Red)



K2-717 40 x 35 x 9 mm
 Disposal stamp
 Requested number or letter must be informed during the order.



K2-716 50 x 35 x 13 mm
 Holder for identification labels











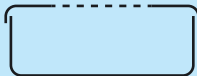

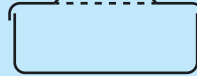
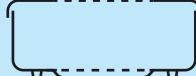















































































































































(-)

Sterile Container System



1/2 Half Size

High Performance Polymers PPSU Lids

Specifications	Lid (perforated)	Lid (Perforated)	Lid (with barrier)	Lid (with barrier)				
								
Sizes	Box (Non-Perforated)	Box (Perforated)	Box (Non-Perforated)	Box (with barrier)				
285 X 280 X h mm 	KP6-500  KP6-501  KP6-502  KP6-503  KP6-504  KP6-505  KT6-500  Transparent	h= 100 mm	KP6-530  KP6-531  KP6-532  KP6-533  KP6-534  KP6-535  KT6-530  Transparent	h= 100 mm	KP7-500  KP7-501  KP7-502  KP7-503  KP7-504  KP7-505  KT7-500  Transparent	h= 105 mm	KP7-530  KP7-531  KP7-532  KP7-533  KP7-534  KP7-535  KT7-530  Transparent	h= 135 mm
285 X 280 X h mm 	KP6-506  KP6-507  KP6-508  KP6-509  KP6-510  KP6-511  KT6-506  Transparent	h= 130 mm	KP6-536  KP6-537  KP6-538  KP6-539  KP6-540  KP6-541  KT6-536  Transparent	h= 130 mm	KP7-506  KP7-507  KP7-508  KP7-509  KP7-510  KP7-511  KT7-506  Transparent	h= 140 mm	KP7-536  KP7-537  KP7-538  KP7-539  KP7-540  KP7-541  KT7-536  Transparent	h= 160 mm
285 X 280 X h mm 	KP6-512  KP6-513  KP6-514  KP6-515  KP6-516  KP6-517  KT6-512  Transparent	h= 150 mm	KP6-542  KP6-543  KP6-544  KP6-545  KP6-546  KP6-547  KT6-542  Transparent	h= 150 mm	KP7-512  KP7-513  KP7-514  KP7-515  KP7-516  KP7-517  KT7-512  Transparent	h= 155 mm	KP7-542  KP7-543  KP7-544  KP7-545  KP7-546  KP7-547  KT7-542  Transparent	h= 175 mm
285 X 280 X h mm 	KP6-518  KP6-519  KP6-520  KP6-521  KP6-522  KP6-523  KT6-518  Transparent	h= 200 mm	KP6-548  KP6-549  KP6-550  KP6-551  KP6-552  KP6-553  KT6-548  Transparent	h= 200 mm	KP7-518  KP7-519  KP7-520  KP7-521  KP7-522  KP7-523  KT7-518  Transparent	h= 205 mm	KP7-548  KP7-549  KP7-550  KP7-551  KP7-552  KP7-553  KT7-548  Transparent	h= 235 mm
285 X 280 X h mm 	KP6-524  KP6-525  KP6-526  KP6-527  KP6-528  KP6-529  KT6-524  Transparent	h= 256 mm	KP6-554  KP6-555  KP6-556  KP6-557  KP6-558  KP6-559  KT6-554  Transparent	h= 256 mm	KP7-524  KP7-525  KP7-526  KP7-527  KP7-528  KP7-529  KT7-524  Transparent	h= 265 mm	KP7-554  KP7-555  KP7-556  KP7-557  KP7-558  KP7-559  KT7-554  Transparent	h= 295 mm
Ps: All container measurements cover the outer size of the lids.								
								

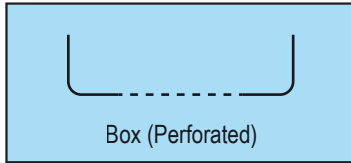

CODE	OUTSIDE	INSIDE	WEIGHT
K6-600	306 X 272 X 95 mm	253 X 258 X 75 mm	1.25 kg
K6-601	306 X 272 X 114 mm	253 X 258 X 94 mm	1.40 kg
K6-602	306 X 272 X 135 mm	253 X 258 X 115 mm	1.55 kg
K6-603	306 X 272 X 184 mm	253 X 258 X 164 mm	1.80 kg
K6-604	306 X 272 X 241 mm	253 X 258 X 221 mm	2.10 kg

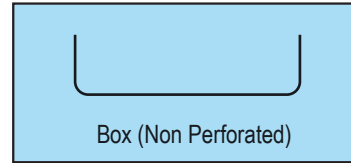

CODE	OUTSIDE	INSIDE	WEIGHT
K6-605	306 X 272 X 95 mm	253 X 258 X 90 mm	1.15 kg
K6-606	306 X 272 X 114 mm	253 X 258 X 109 mm	1.25 kg
K6-607	306 X 272 X 135 mm	253 X 258 X 130 mm	1.35 kg
K6-608	306 X 272 X 184 mm	253 X 258 X 179 mm	1.55 kg
K6-609	306 X 272 X 241 mm	253 X 258 X 236 mm	2.00 kg



Perforated Lids

Weight: 0.77 kg

- KP6-630**
- KP6-631**
- KP6-632**
- KP6-633**
- KP6-634**
- KP6-635**
- KT6-630**

Safety Lids (For perforated Lids)

Weight: 0.60 kg

- KP6-700**
- KP6-701**
- KP6-702**
- KP6-703**
- KP6-704**
- KP6-705**
- KT6-700**

Bio Barrier Lids

Weight: 0.67 kg

- KP7-630**
- KP7-631**
- KP7-632**
- KP7-633**
- KP7-634**
- KP7-635**
- KT7-630**

Safety Lid (For Bio Barrier Lids)

Weight: 0.73 kg

- KP7-412**
- KP7-413**
- KP7-414**
- KP7-415**
- KP7-416**
- KP7-417**
- KT7-412**



Basket Made From Stainles Steel Wire Mesh



- K2-490** 255 x 250 x 30 mm
- K2-491** 255 x 250 x 50 mm
- K2-492** 255 x 250 x 70 mm
- K2-493** 255 x 250 x 100 mm

WIRE BASKET



- K3-1040** 255 x 250 x 30 mm
- K3-1041** 255 x 250 x 50 mm
- K3-1042** 255 x 250 x 70 mm
- K3-1043** 255 x 250 x 100 mm
- K3-1045** ONLY LID, for baskets

WIRE BASKET WITH LID

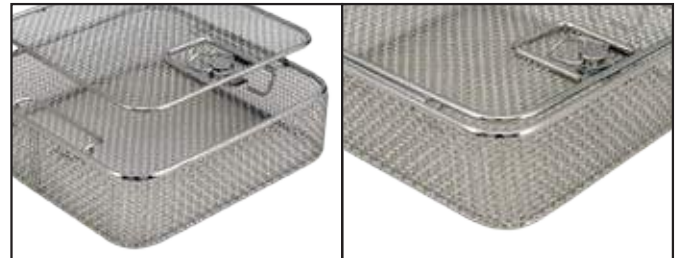
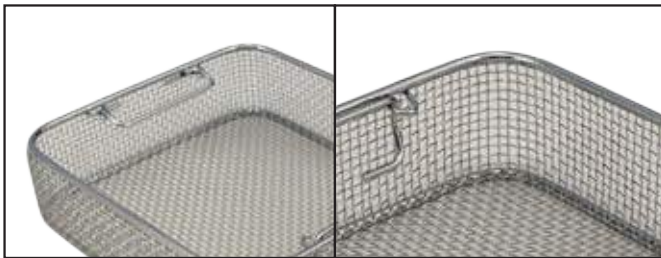

Wire Basket With Perforated Metal Plate



- K2-491 P** 255 x 250 x 50 mm
- K2-492 P** 255 x 250 x 70 mm
- K2-493 P** 255 x 250 x 100 mm

WIRE BASKET



- K3-1041 P** 255 x 250 x 50 mm
- K3-1042 P** 255 x 250 x 70 mm
- K3-1043 P** 255 x 250 x 100 mm
- K3-1045 P** ONLY LID, for baskets



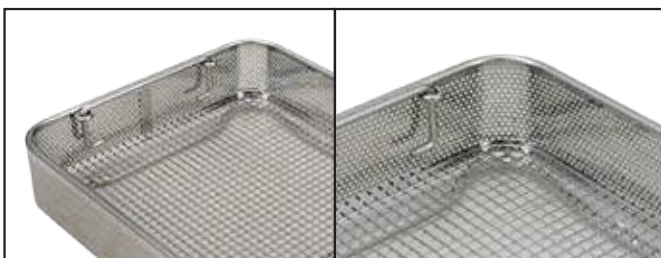



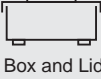
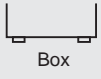
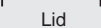





WIRE BASKET WITH LID



Basket Made From Stainless Steel Sheet

 <p>BASKET</p>	 <p>Box and Lid</p>	<p>K3-732 244 x 253 x 30 mm K3-733 244 x 253 x 50 mm K3-734 244 x 253 x 70 mm K3-735 244 x 253 x 100 mm</p>
	 <p>Box</p>	<p>K3-752 244 x 253 x 30 mm K3-753 244 x 253 x 50 mm K3-754 244 x 253 x 70 mm K3-755 244 x 253 x 100 mm</p>
	 <p>Lid</p>	<p>K3-763 244 x 253 x 10 mm</p>



 <p>K2-560 RED</p>		 <p>K2-570</p>
 <p>K2-561 BLUE</p>		 <p>K2-571</p>
 <p>K2-562 GREEN</p>		 <p>K2-572</p>
 <p>K2-563 YELLOW</p>		 <p>K2-573</p>
 <p>K2-564 GREY</p>		 <p>K2-574</p>
 <p>K2-565 BLACK</p>		 <p>K2-575</p>









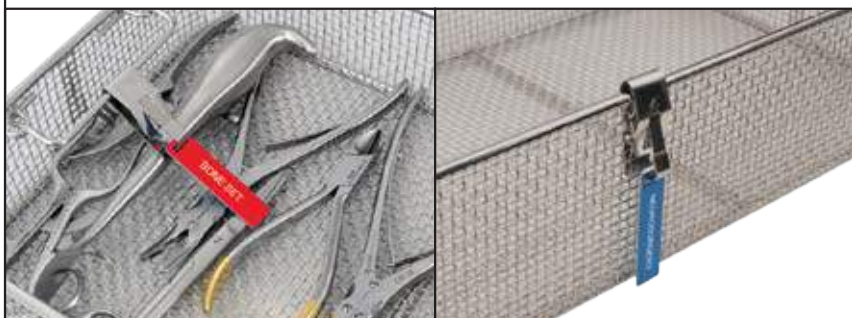









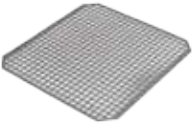





Coloured identification labels Engraved to your specification

Grey coloured recommended for use in Sterrad.
Color fading By effect of Hydrogen Peroxide Gas Plasma on other colors.



K2-569
Information board with clip





































































 <p>K2-483 255 x 245 x 130 mm K2-484 255 x 245x 180 mm DIVIDERS</p>	 <p>K2-482 255 x 255 x 30 mm WIRE BASE</p>	<p>(-)</p>
 <p>K3-1094 Rack for kerrison Holds 10 kerrison punches Fits into a 1/2 and 1/1 size 20 cm deep container Wire basket 1/2 50 mm Wire basket 1/1 50 mm Container 1/2 200 mm Container 1/2 200 mm</p>	 <p>K3-481 255 x 255 x 30 mm DRAPE RETAINER</p>	 <p>K2-480 255 x 255 mm DRAPE RETAINER</p>
 <p>K3-1119 245 x 130 x 55 mm Aluminium basket, with lid</p>	 <p>K3-1120 245 x 130 x 70 mm Aluminium basket, with lid</p>	 <p>K3-1121 245 x 130 x 105 mm Aluminium basket, with lid</p>
 <p>K2-521 255 x 255 mm Silicone mat</p>	 <p>K2-531 480 x 250 x 2.0 mm Silicone mat</p>	 <ul style="list-style-type: none"> ● K2-700 ● K2-701 ● K2-702 ● K2-703 ● K2-704 ● K2-705
 <p>K2-740 Single use paper filter 100 pcs with indicator</p>	 <p>K2-742 Teflon filter Number of sterilization cycle > 1200</p>	 <p>K2-730 Filter Dispenser</p>
 <ul style="list-style-type: none"> K2-710 Red K2-711 Yellow K2-712 Green K2-713 Blue K2-714 Grey K2-715 Black 	 <p>K2-673 Labels, paper 100 pcs. With indicator. For small size and special containers</p>	 <p>K2-672 Labels, paper 100 pcs. With indicator. For full and half size containers</p>
 <p>K2-663 Security seal, made of plastic 100 pcs. with indicator. (Blue)</p>	 <p>K2-664 Security seal, made of plastic 100 pcs.(Blue)</p>	 <p>K2-661 Security seal, made of plastic 100 pcs. with number.(Blue)</p>
 <p>K2-662 Security seal, made of plastic 100 pcs. with indicator.(Red)</p>	 <p>K2-660 Security seal, made of plastic 100 pcs.(Red)</p>	 <p>K2-665 Security seal, made of plastic 100 pcs. with number.(Red)</p>
 <p>K2-717 40 x 35 x 9 mm Disposal stamp Requested number or letter must be informed during the order.</p>	 <p>K2-716 50 x 35 x 13 mm Holder for identification labels</p>	<p>(-)</p>

Sterile Container System



Dental, Mini & special Model

Edition 6

Specifications Sizes	Lid (Perforated)	Lid (Perforated)	Lid (Non Perforated)		
	 Box (Non-Perforated)	 Box (Perforated)	 Box (Non-Perforated)	 Box (Perforated)	 Box (Non-Perforated)
320 X 190 X 50 mm 	K6-1800  K6-1801  K6-1802  K6-1803  K6-1804  K6-1805 	K6-1820  K6-1821  K6-1822  K6-1823  K6-1824  K6-1825 	K6-1840  K6-1841  K6-1842  K6-1843  K6-1844  K6-1845 	K6-1860 	K6-1865 
320 X 190 X 65 mm 	K6-1806  K6-1807  K6-1808  K6-1809  K6-1810  K6-1811 	K6-1826  K6-1827  K6-1828  K6-1829  K6-1830  K6-1831 	K6-1846  K6-1847  K6-1848  K6-1849  K6-1850  K6-1851 	K6-1861 	K6-1866 
320 X 190 X 130 mm 	K6-1812  K6-1813  K6-1814  K6-1815  K6-1816  K6-1817 	K6-1832  K6-1833  K6-1834  K6-1835  K6-1836  K6-1837 	K6-1852  K6-1853  K6-1854  K6-1855  K6-1856  K6-1857 	K6-1862 	K6-1867 

Ps: All container measurements cover the outer size of the lids.



K3-1070 274 x 172 x 43 mm
WIRE BASKET



K3-611 274 x 172 x 43 mm
WIRE BASKET WITH LID.



K3-609 273 x 180 x 13 mm
STORAGE FRAME
for dental model



K2-529 260 x 180 mm
SILICONE MAT



K3-610 277 x 175 mm
DRAPE RETAINER

Perforated Bottoms



outside 320 x 186 x 38 mm
inside 276 x 185 x 23 mm
weight 0,45 kg

K6-1860

Solid Bottoms



outside 320 x 186 x 38 mm
inside 276 x 185 x 36 mm
weight 0,35 kg

K6-1865



outside 320 x 186 x 55 mm
inside 276 x 185 x 40 mm
weight 0,50 kg

K6-1861



outside 320 x 186 x 55 mm
inside 276 x 185 x 43 mm
weight 0,40 kg

K6-1866



outside 320 x 186 x 123 mm
inside 276 x 185 x 108 mm
weight 0,70 kg

K6-1862



outside 320 x 186 x 123 mm
inside 276 x 185 x 121 mm
weight 0,65 kg

K6-1867

Perforated Lids



K6-1880	
K6-1881	
K6-1882	
K6-1883	
K6-1884	
K6-1885	

Weight: 0.50 kg



K3-612
Single use paper filter 100 pcs.
with indicator Aygun mark.



K3-615
Single use paper filter 100 pcs.
With indicator. No marking.



K2-743
Teflon filter
Number of sterilization cycle > 1200

Bio-Barrier Lids



K7-1880	
K7-1881	
K7-1882	
K7-1883	
K7-1884	
K7-1885	

Weight: 0.90 kg





































































Removal Lids



K6-1870	
K6-1871	
K6-1872	
K6-1873	
K6-1874	
K6-1875	

Weight: 0.60 kg



Specifications Sizes	Lid (Perforated)	Lid (Perforated)	Lid (Non Perforated)		
	 Box (Non-Perforated)	 Box (Perforated)	 Box (Non-Perforated)	 Box (Perforated)	 Box (Non-Perforated)
315 X 135 X 40 mm 	K6-1900  K6-1901  K6-1902  K6-1903  K6-1904  K6-1905 	K6-1920  K6-1921  K6-1922  K6-1923  K6-1924  K6-1925 	K6-1940  K6-1941  K6-1942  K6-1943  K6-1944  K6-1945 	K6-1960 	K6-1965 
315 X 135 X 70 mm 	K6-1906  K6-1907  K6-1908  K6-1909  K6-1910  K6-1911 	K6-1926  K6-1927  K6-1928  K6-1929  K6-1930  K6-1931 	K6-1946  K6-1947  K6-1948  K6-1949  K6-1950  K6-1951 	K6-1961 	K6-1966 
315 X 135 X 100 mm 	K6-1912  K6-1913  K6-1914  K6-1915  K6-1916  K6-1917 	K6-1932  K6-1933  K6-1934  K6-1935  K6-1936  K6-1937 	K6-1952  K6-1953  K6-1954  K6-1955  K6-1956  K6-1957 	K6-1962 	K6-1967 

Ps: All container measurements cover the outer size of the lids.



K3-1073 267 x 125 x 50 mm
WIRE BASKET



K2-993 267 x 125 x 50 mm
WIRE BASKET WITH LID.



K2-990 270 x 125 mm
DRAPE RETAINER



K2-991
Portable carrier for small containers.
Wire suspenders, adjustable as required.
Adjusting key of suspender is included.
Width: 325 mm, Height: 328 mm, Depth: 145 mm



K2-992 270 x 125 mm
WIRE BASE



K2-520 275 x 125 mm
SILICONE MAT

Perforated Bottoms



outside 315 x 132 x 32 mm
inside 273 x 128 x 24 mm
weight 0,30 kg

K6-1960

Solid Bottoms



outside 296 x 132 x 32 mm
inside 273 x 128 x 30 mm
weight 0,20 kg

K6-1965



outside 315 x 132 x 58 mm
inside 273 x 128 x 50 mm
weight 0,40 kg

K6-1961



outside 296 x 132 x 58 mm
inside 273 x 128 x 56 mm
weight 0,35 kg

K6-1966



outside 315 x 132 x 92 mm
inside 273 x 128 x 84 mm
weight 0,50 kg

K6-1962



outside 296 x 132 x 92 mm
inside 273 x 128 x 90 mm
weight 0,45 kg

K6-1967



K2-760
Single use paper filter 100 pcs.
with indicator. Aygun mark.



K2-761
Single use paper filter 100 pcs.
With indicator. No marking.



K2-744
Teflon filter
Number of sterilization cycle > 1200

Perforated Lid



K6-1970	
K6-1971	
K6-1972	
K6-1973	
K6-1974	
K6-1975	

Weight: 0.35 kg

Removal Lids











































K6-1980	
K6-1981	
K6-1982	
K6-1983	
K6-1984	
K6-1985	

Weight: 0.30 kg











































IMPLANT Model Containers

Specifications / Sizes	Lid (Perforated)	Lid (Perforated)	Lid (Non Perforated)	NON FILTER
	Box (Non-Perforated)	Box (Perforated)	Box (Non-Perforated)	
300 X 149 X 65 mm 	K5-010  K5-011  K5-012  K5-013  K5-014  K5-015 	K5-022  K5-023  K5-024  K5-025  K5-026  K5-027 	K5-034  K5-035  K5-036  K5-037  K5-038  K5-039 	
500 X 169 X 75 mm 	K5-016  K5-017  K5-018  K5-019  K5-020  K5-021 	K5-028  K5-029  K5-030  K5-031  K5-032  K5-033 	K5-040  K5-041  K5-042  K5-043  K5-044  K5-045 	

Ps: All container measurements cover the outer size of the lids.







MINI IMPLANT Model Containers

Specifications / Sizes	Lid (Perforated)	Lid (Perforated)	Lid (Non Perforated)	NON FILTER
	Box (Non-Perforated)	Box (Perforated)	Box (Non-Perforated)	
160 X 70 X 60 mm 	K5-200  K5-201  K5-202  K5-203  K5-204  K5-205 	K5-212  K5-213  K5-214  K5-215  K5-216  K5-217 	K5-224  K5-225  K5-226  K5-227  K5-228  K5-229 	
200 X 145 X 60 mm 	K5-206  K5-207  K5-208  K5-209  K5-210  K5-211 	K5-218  K5-219  K5-220  K5-221  K5-222  K5-223 	K5-230  K5-231  K5-232  K5-233  K5-234  K5-235 	

Ps: All container measurements cover the outer size of the lids.

**BRUSH Model
Containers**



-  **K2-044** Black
-  **K2-045** Red
-  **K2-046** Blue
-  **K2-047** Green
-  **K2-048** Yellow
-  **K2-049** Grey

Container for brush 280 x 285 x 85 mm with wall mounting fixtures, Maximum 20 each brushes can be stored in container. To take the brush, please move the handle to right or left direction under the container.

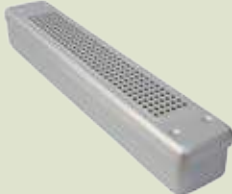

non filter

Specifications / Sizes	Lid (Perforated)	Lid (Perforated)
	Box (Non-Perforated)	Box (Perforated)
250 X 60 X 50 mm 	K5-060 ● K5-061 ● K5-062 ● K5-063 ● K5-064 ● K5-065 ●	K5-072 ● K5-073 ● K5-074 ● K5-075 ● K5-076 ● K5-077 ●
450 X 70 X 70 mm 	K5-066 ● K5-067 ● K5-068 ● K5-069 ● K5-070 ● K5-071 ●	K5-078 ● K5-079 ● K5-080 ● K5-081 ● K5-082 ● K5-083 ●

Ps: All container measurements cover the outer size of the lids.

















































SCOPY Model Containers

Specifications / Sizes	Lid (Perforated)	Lid (Perforated)
	Box (Non-Perforated)	Box (Perforated)
250 X 60 X 50 mm 	K5-100 ● K5-101 ● K5-102 ● K5-103 ● K5-104 ● K5-105 ●	K5-115 ● K5-116 ● K5-117 ● K5-118 ● K5-119 ● K5-120 ●
450 X 70 X 70 mm 	K5-106 ● K5-107 ● K5-108 ● K5-109 ● K5-110 ● K5-111 ●	K5-121 ● K5-122 ● K5-123 ● K5-124 ● K5-125 ● K5-126 ●

Ps: All container measurements cover the outer size of the lids.



SCOPY Model Containers
(with silicon stand, lock, label)

Specifications Sizes	Lid (Perforated)	Lid (Perforated)	Lid (Non Perforated)		
	 Box (Non-Perforated)	 Box (Perforated)	 Box (Non-Perforated)	 Box (Perforated)	 Box (Non-Perforated)
285 X 280 X 55 mm 	K6-710  K6-711  K6-712  K6-713  K6-714  K6-715 	K6-730  K6-731  K6-732  K6-733  K6-734  K6-735 	K6-750  K6-751  K6-752  K6-753  K6-754  K6-755 	K6-770 	K6-775 
285 X 280 X 85 mm 	K6-716  K6-717  K6-718  K6-719  K6-720  K6-721 	K6-736  K6-737  K6-738  K6-739  K6-740  K6-741 	K6-756  K6-757  K6-758  K6-759  K6-760  K6-761 	K6-771 	K6-776 

Ps: All container measurements cover the outer size of the lids.



K2-490 255 x 250 x 30 mm
K2-491 255 x 250 x 50 mm
 WIRE BASKET



K2-482 255 x 255 x 30 mm
 WIRE BASE



K2-480 255 x 255 mm
 DRAPE RETAINER



K2-481 255 x 255 x 30 mm
 DRAPE RETAINERT

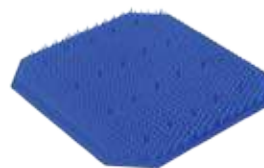

K2-521 255 x 255 mm
 SILICON MAT



K2-740
 Single use paper filter 100 pcs.



K2-742
 Teflon filter
 Number of sterilization cycle > 1200

Perforated Bottoms

	outside 209 x 275 x 40 mm
	inside 264 x 270 x 19 mm
	weight 0,70 kg

K6-1770

Solid Bottoms

	outside 290x 275 x 40 mm
	inside 264 x 270 x 35 mm
	weight 0,60 kg

K6-1775







	outside 290 x 275 x 72 mm
	inside 264 x 270 x 52 mm
	weight 0,90 kg

K6-1771

	outside 290 x 275 x 72 mm
	inside 264 x 270 x 66 mm
	weight 0,70 kg







K6-1776

Perforated Lids

	K6-1780 
	K6-1781 
	K6-1782 
	K6-1783 
	K6-1784 
	K6-1785 

Weight: 0.65 kg

Bio-Barrier Lids

	K7-1780 
	K7-1781 
	K7-1782 
	K7-1783 
	K7-1784 
	K7-1785 

Weight: 0.85 kg

Safety Lids

	K6-1418 
	K6-1419 
	K6-1420 
	K6-1421 
	K6-1422 
	K6-1423 

Weight: 0.55 kg

Bio-Barrier Safety Lids

	K7-1418 
	K7-1419 
	K7-1420 
	K7-1421 
	K7-1422 
	K7-1423 

Weight: 0.60 kg

Removal Lids

	K6-1790 
	K6-1791 
	K6-1792 
	K6-1793 
	K6-1794 
	K6-1795 

Weight: 0.50 kg



Sterile Container System

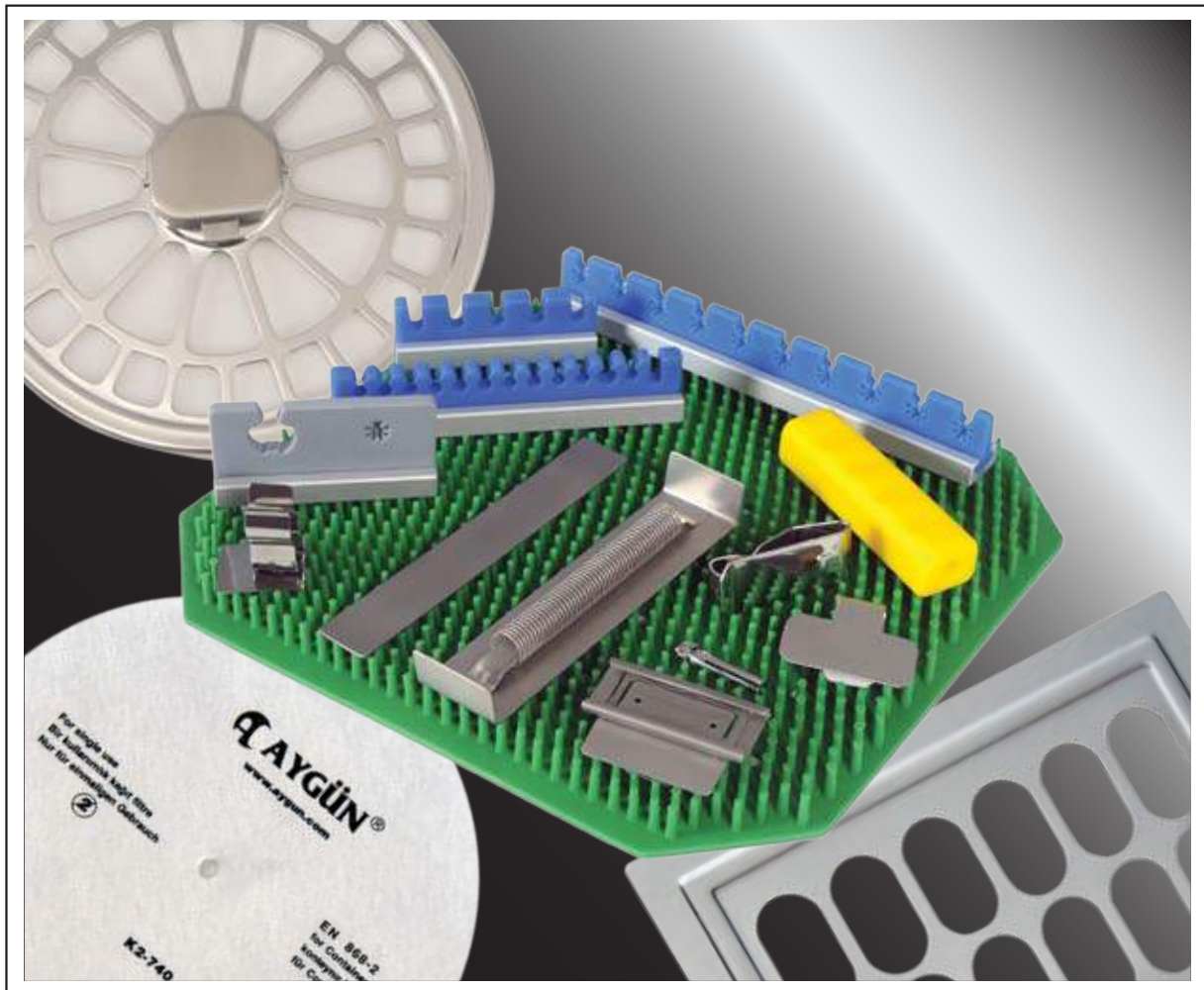

Accessories

Edition 6



The security plastic seals will be broken upon the lock is opened and this action makes it possible to follow up the sterilization process.



K2-663
Security seal, made of plastic
100 pcs. with indicator. (Blue)



K2-662
Security seal, made of plastic
100 pcs. with indicator. (Red)



K2-664
Security seal, made of plastic
100 pcs. (Blue)



K2-660
Security seal, made of plastic
100 pcs. (Red)



K2-661
Security seal, made of plastic
100 pcs. with number. (Blue)



K2-665
Security seal, made of plastic
100 pcs. with number. (Red)



K2-672
Labels, paper 100 pcs.
With indicator.
For full and half size containers



K2-673
Labels, paper 100 pcs.
With indicator.
For small size and special
containers

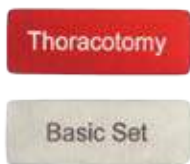

- **K2-700**
- **K2-701**
- **K2-702**
- **K2-703**
- **K2-704**
- **K2-705**

Coloured identification labels
Engraved to your specifications
Maximum 16 letters



K2-690
Dispenser for idetification labels



K2-680
Dispenser for identification labels

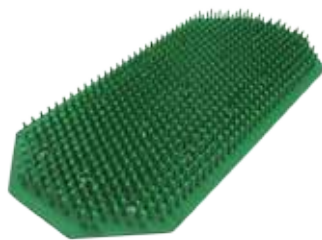
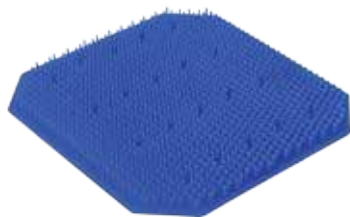
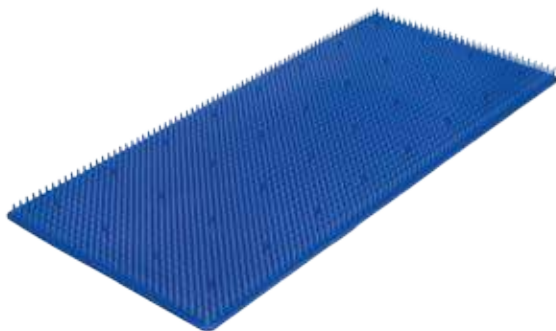

K2-520	275 x 125 mm
K2-529	260 x 180 mm
K2-521	250 x 235 mm
K2-527	230 x 220 mm
K2-523	300 x 300 mm
K2-524	380 x 230 mm
K2-525	440 x 230 mm
K2-528	470 x 230 mm
K2-526	520 x 230 mm

Silicone Mat

K2-530	250 x 240 x 2.0 mm
K2-531	480 x 250 x 2.0 mm

Silicone mat

Enables surgical instruments to be stored without slip and dry well.





- K12-100** L= 250 mm H= 41 mm
- K12-101** L= 152 mm H= 41 mm
- K12-102** L= 125 mm H= 41 mm
- K12-145** L= 97 mm H= 41 mm

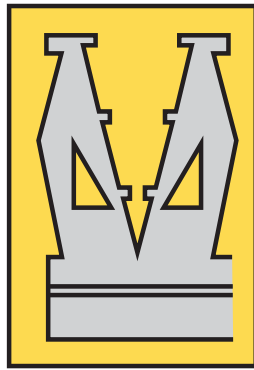

- K12-103** L= 240 mm H= 41 mm
- K12-104** L= 150 mm H= 41 mm
- K12-105** L= 120 mm H= 41 mm
- K12-146** L= 90 mm H= 41 mm

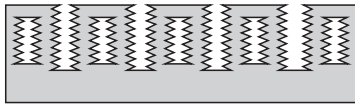
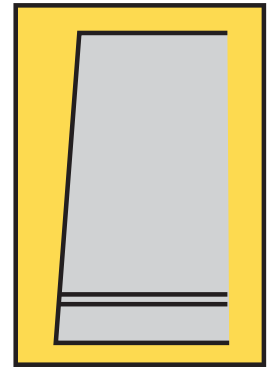

- K12-106** L= 238 mm H= 41 mm
- K12-107** L= 150 mm H= 41 mm
- K12-108** L= 119 mm H= 41 mm
- K12-147** L= 87 mm H= 41 mm

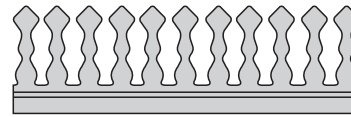
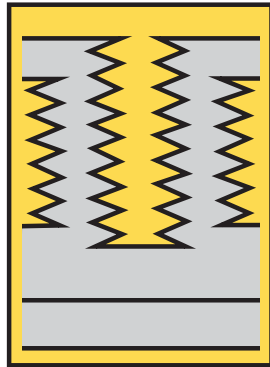

- K12-109** L= 238 mm H= 41 mm
- K12-110** L= 158 mm H= 41 mm
- K12-111** L= 112 mm H= 41 mm
- K12-148** L= 77 mm H= 41 mm

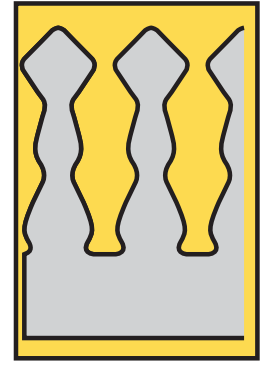

- K12-112** L= 178 mm H= 20 mm
- Instruments holder, from Ø 3 to 8 mm

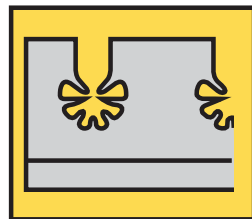

- K12-113** L= 73 mm H= 20 mm
- Instruments holder, Ø 5 mm

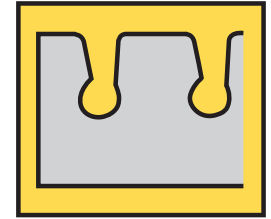

- K12-114** L= 73 mm H= 20 mm
- Instruments holder, Ø 3 mm

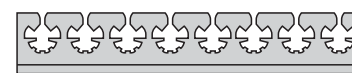
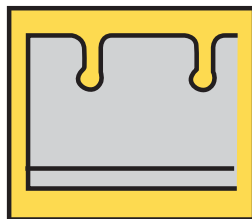

- K12-115** L= 178 mm H= 30 mm
- Instruments holder, from Ø 3 to 8 mm

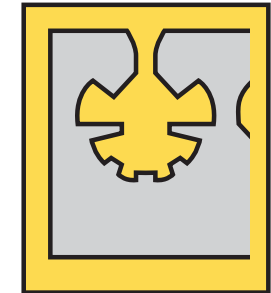

- K12-116** L= 121 mm H= 18 mm

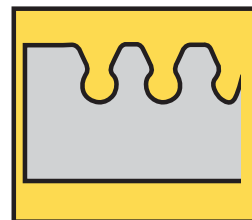

- K12-117** L= 123 mm H= 18 mm

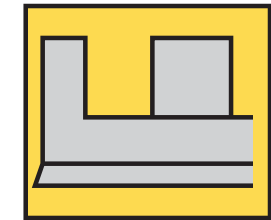

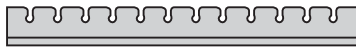

K12-124 L= 178 mm H= 20 mm
Instruments holder, from Ø 3 mm

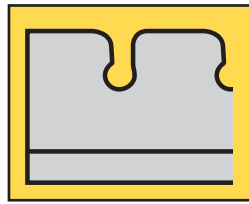

K12-125 L= 178 mm H= 20 mm
Instruments holder, from Ø 5 mm

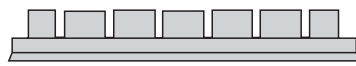
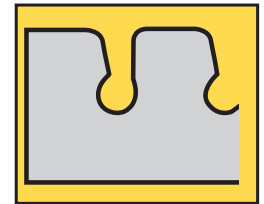

K12-123 L= 123 mm H= 18 mm

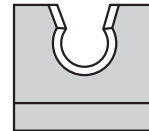
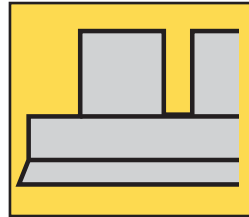

K12-127 L= 23.5 mm H= 21 mm
Ø 8 mm

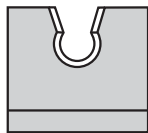
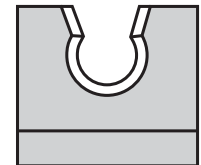

K12-129 L= 23.5 mm H= 21 mm
Ø 5 mm

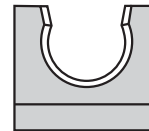
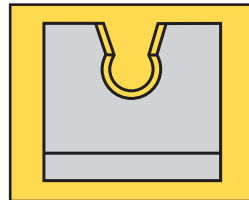

K12-128 L= 23.5 mm H= 21 mm
Ø 13 mm

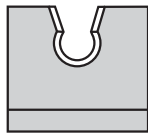
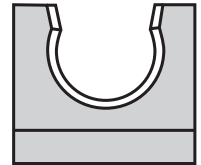

K12-126 L= 23.5 mm H= 21 mm
Ø 10.5 mm

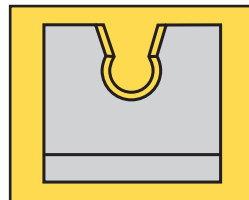

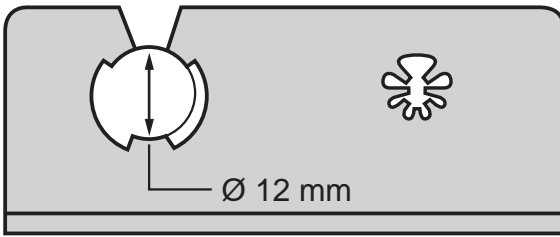

K12-141 L= 72 mm H= 30 mm
Endoscope holder, double
one side Ø 15 mm open
one side from Ø 3 to Ø 15 mm

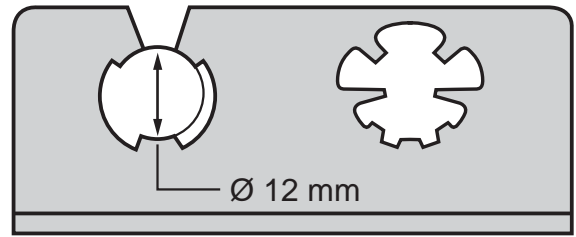

K12-130 L= 72 mm H= 30 mm
Endoscope holder, double
one side Ø 15 mm open
one side from Ø 3 to Ø 15 mm

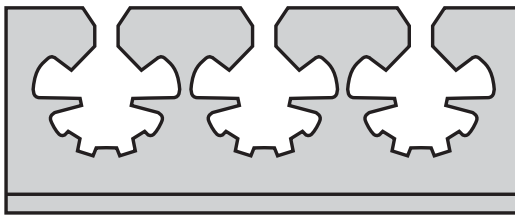

K12-131 L= 72 mm H= 30 mm
Instruments holder
from Ø 3 to Ø 15 mm

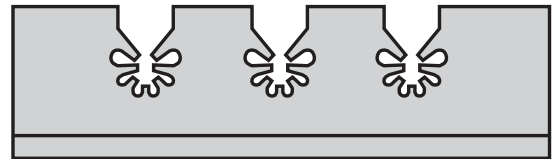

K12-132 L= 72 mm H= 30 mm
Instruments holder
from Ø 3 to Ø 8 mm

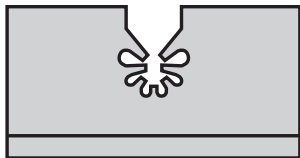

K12-133 L= 38 mm H= 20 mm
Endoscope holder, double
one side Ø 12 open
one side from Ø 3 to Ø 8 mm

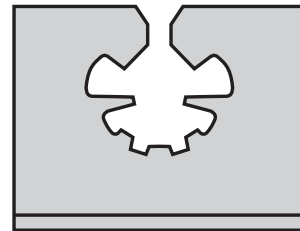

K12-134 L= 38 mm H= 30 mm
Endoscope holder, double
one side Ø 12 open
one side from Ø 3 to Ø 8 mm

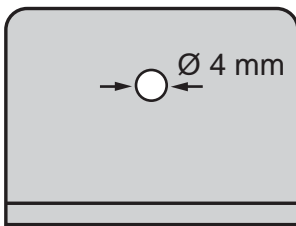

K12-135 L= 38 mm H= 29 mm
Endoscope holder, Ø 4 mm closed

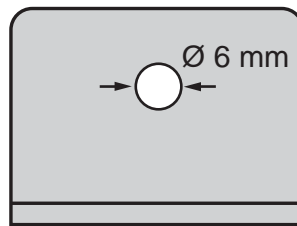

K12-136 L= 38 mm H= 29 mm
Endoscope holder, Ø 6 mm closed

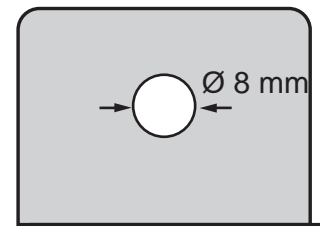

K12-137 L= 38 mm H= 29 mm
Endoscope holder, Ø 8 mm closed

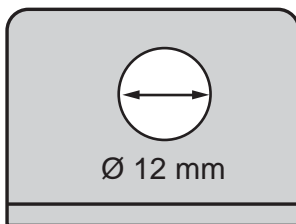

K12-138 L= 38 mm H= 29 mm
Endoscope holder, Ø 12 mm closed

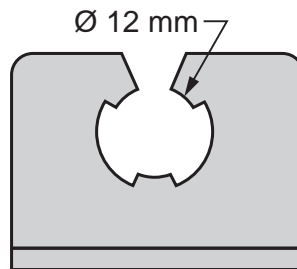

K12-139 L= 38 mm H= 29 mm
Endoscope holder, Ø 12 mm closed

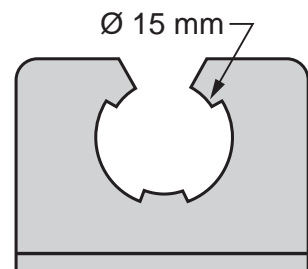

K12-140 L= 38 mm H= 29 mm
Endoscope holder, Ø 15 mm closed



K2-740
Single use paper filter 100 pcs.
with indicator. Aygun mark.



K2-741
Single use paper filter 100 pcs.
With indicator. No marking



K2-742
Teflon filter
Number of sterilization cycle > 1200



K3-612
Single use paper filter 100 pcs.
with indicator. Aygun mark.



K3-615
Single use paper filter 100 pcs.
With indicator. No marking



K2-743
Teflon filter
Number of sterilization cycle > 1200

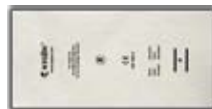

K2-760
Single use paper filter 100 pcs.
with indicator. Aygun mark.



K2-761
Single use paper filter 100 pcs.
With indicator. No marking

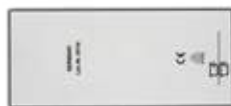

K2-744
Teflon filter
Number of sterilization cycle > 1200





K2-720
Filter retainer, for 1/1, 3/4, 1/2, XL
For disposable paper filter
K2-721
For PTFE Teflon filter



K2-730
Filter dispenser



K2-1715
Filter Retainer, for dental model



K2-1708
Filter dispenser



K2-1716
Filter Retainer, for mini model



K2-1709
Filter dispenser



SILICONE GASKETS FOR LIDS



	Model	Size
K3-950	Mini	300 x 140 mm
K3-951	Dental	310 x 190 mm
K3-952	Flat	285 x 280 mm
K3-953	1/2	285 x 280 mm
K3-954	3/4	465 x 280 mm
K3-955	1/1	580 x 280 mm
K3-956	XL	590 x 370 mm



K3-1000
Silicone adhesive

For mounting, K3-1000 silicone adhesive is used

- K2-710** Red
- K2-711** Yellow
- K2-712** Green
- K2-713** Blue
- K2-714** Grey
- K2-715** Black

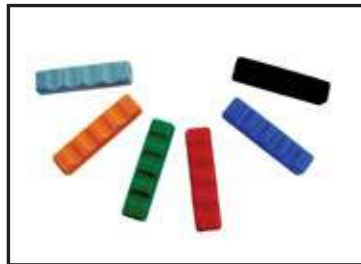

Silicone handle has available in six different colors and detachable by user.
Patent No: 200801401



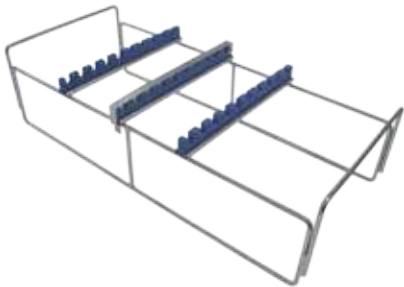

K3-1090

Rack, for endoscopy
Holds 10 endoscopic instruments
Fits into a 1/1 size 20 cm deep container

Wire basket 1/1 50 mm
Container 1/1 200 mm
Silicone mat 520 x 230 mm

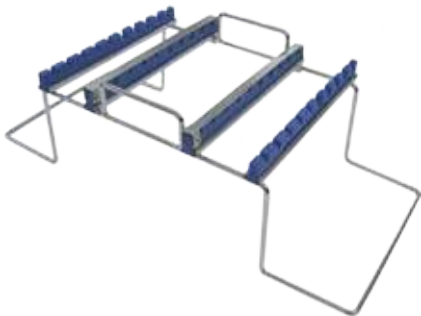

K3-1092

Rack, for arthroscopy
Holds 20 arthroscopy punches
Fits into a 1/1 size 20 cm deep container

Wire basket 1/1 50 mm
Container 1/1 200 mm
Silicone mat 440 x 230 mm



K3-1094

Rack, for Kerrison
Holds 10 Kerrison punches
20 cm deep container

Wire basket 1/2 50 mm
Wire basket 1/1 50 mm
Container 1/2 200 mm
Container 1/1 200 mm





K2-716
Holder for identification labels
50 x 35 x 13 mm



K2-717
Disposal stamp
40 x 35 x 9 mm
Requested number or letter
must be informed during
the order.



K2-691
Storage stand
390 x 85 x 153 mm



- K2-560** RED
- K2-561** BLUE
- K2-562** GREEN
- K2-563** YELLOW
- K2-564** GREY
- K2-565** BLACK



- K2-570**
- K2-571**
- K2-572**
- K2-573**
- K2-574**
- K2-575**

Coloured identification labels Engraved to your specification

Grey coloured recommended for use in Sterrad.
Color fading By effect of Hydrogen Peroxide Gas Plasma on other colors.



K2-569
Information board with clip





K2-588
Fixation clamp



K2-651
Holding pin for instruments



K2-650
Holding pin for divider

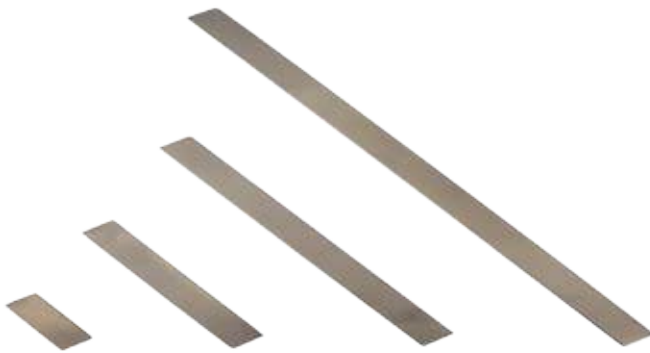

K2-645
DIVIDER
50 X 20 mm

K2-646
DIVIDER
130 X 20 mm

K2-647
DIVIDER
225 X 20 mm

K2-648
DIVIDER
460 X 20 mm



K2-580
FIXATION CLAMP
Ø 7 - 12 mm



K2-581
FIXATION CLAMP
Ø 12 - 16 mm



K2-582
FIXATION CLAMP
Ø 16 - 26 mm



K2-583
FIXATION CLAMP
Ø 26 - 36 mm



K2-584
FIXATION CLAMP
Ø 36 - 45 mm

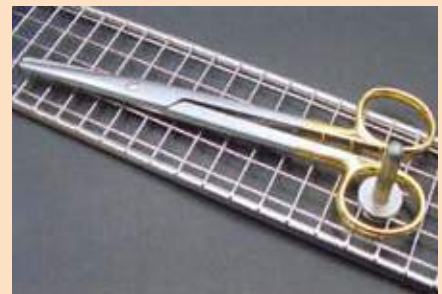
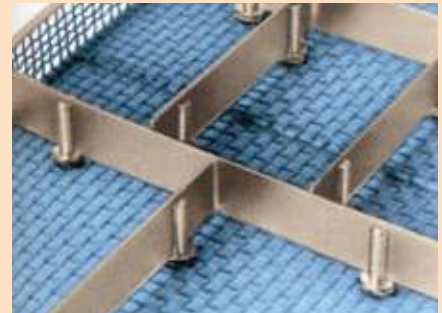



M8-508
Rack for 24 burs with shanks Ø 2.35 mm



M8-509
Rack for 15 pcs of instruments



M8-511
Rack for 12 pcs of instruments



M8-490
Tilttable holding device
for 6 micro heads



M8-510
Spray oil

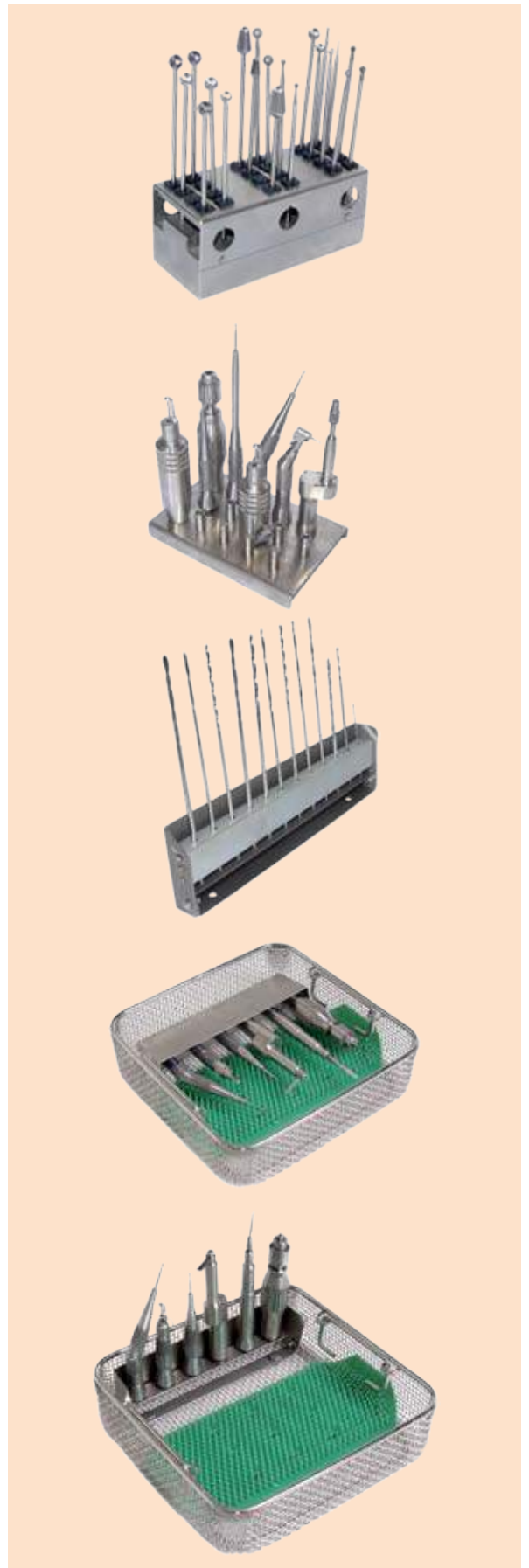



K2-600 40 X 5 X 15 mm
DIVIDER (use with **K2-601** and **K2-602**)



K2-601 23 cm
K2-602 47 cm
Sliding rails with securing screws



K2-604 23 cm
K2-605 47 cm
Limiting bar, with securing screws



K2-607
Spiral holding device



K2-609
Spiral holding device





K2-615	11 mm
K2-616	17 mm
K2-617	23 mm
K2-618	47 mm

Limiting bar



K2-620
Spiral holding



K2-622
Spiral holding



K2-625
Spiral holding



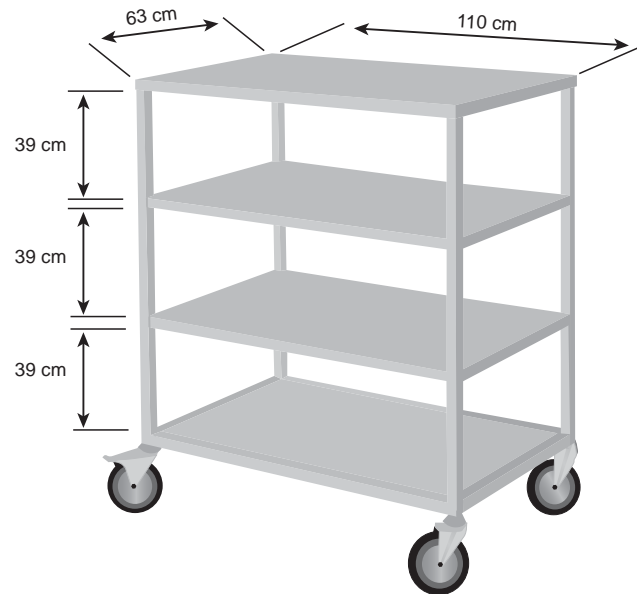

K2-802

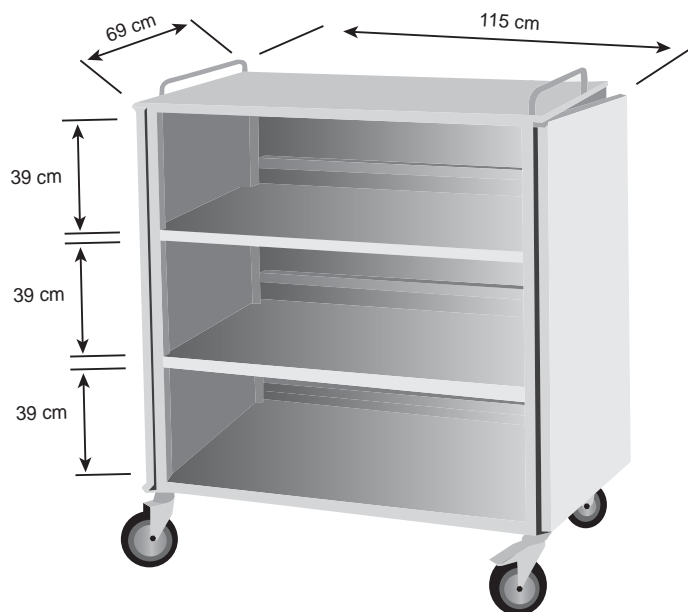

K2-803

Sterile Container System

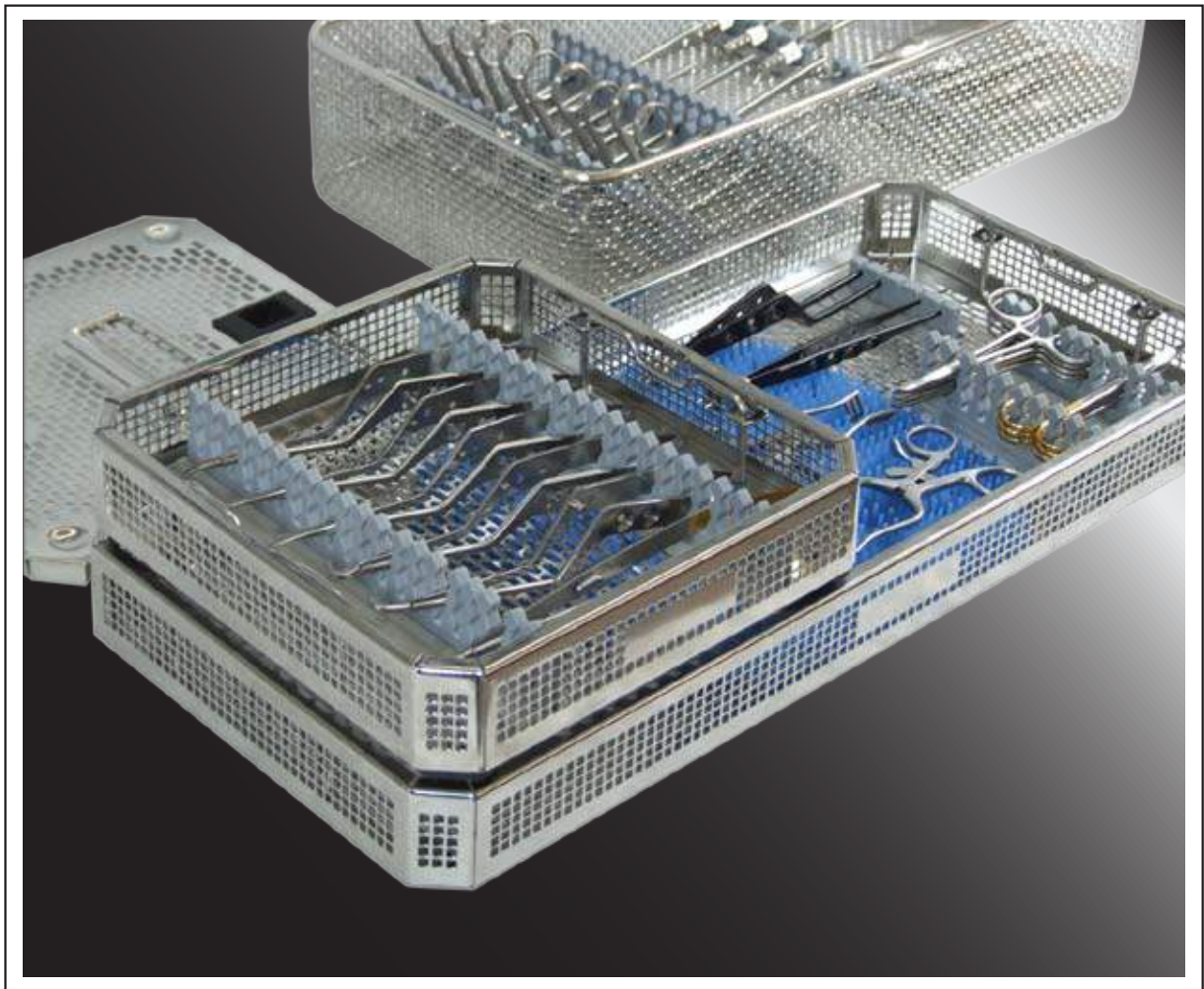

Baskets

Edition 6



K3-1010 540 x 250 x 30 mm
K3-1011 540 x 250 x 50 mm
K3-1012 540 x 250 x 70 mm
K3-1013 540 x 250 x 100 mm

wire basket with lid

K3-1014 ONLY LID, For baskets



K2-460 540 x 250 x 30 mm
K2-461 540 x 250 x 50 mm
K2-462 540 x 250 x 70 mm
K2-463 540 x 250 x 100 mm

wire basket



K3-1020 480 x 250 x 30 mm
K3-1021 480 x 250 x 50 mm
K3-1022 480 x 250 x 70 mm
K3-1023 480 x 250 x 100 mm

wire basket with lid

K3-1024 ONLY LID, For baskets



K2-450 480 x 250 x 30 mm
K2-451 480 x 250 x 50 mm
K2-452 480 x 250 x 70 mm
K2-453 480 x 250 x 100 mm

wire basket



K3-1030 405 x 250 x 30 mm
K3-1031 405 x 250 x 50 mm
K3-1032 405 x 250 x 70 mm
K3-1033 405 x 250 x 100 mm

wire basket with lid

K3-1034 ONLY LID, For baskets



K2-1500 405 x 250 x 30 mm
K2-1501 405 x 250 x 50 mm
K2-1502 405 x 250 x 70 mm
K2-1503 405 x 250 x 100 mm

wire basket



K3-1040 255 x 250 x 30 mm
K3-1041 255 x 250 x 50 mm
K3-1042 255 x 250 x 70 mm
K3-1043 255 x 250 x 100 mm

wire basket with lid



K3-1045 ONLY LID, For baskets



K2-490 255 x 250 x 30 mm
K2-491 255 x 250 x 50 mm
K2-492 255 x 250 x 70 mm
K2-493 255 x 250 x 100 mm

wire basket



Wire Basket With Perforated Metal Plate

	<p>K2-461 P 540 x 250 x 50 mm K2-462 P 540 x 250 x 70 mm K2-463 P 540 x 250 x 100 mm</p>		<p>K3-1011 P 540 x 250 x 50 mm K3-1012 P 540 x 250 x 70 mm K3-1013 P 540 x 250 x 100 mm</p>
	<p>K2-451 P 480 x 250 x 50 mm K2-452 P 480 x 250 x 70 mm K2-453 P 480 x 250 x 100 mm</p>		<p>K3-1014 P ONLY LID, for baskets</p>
<p>WIRE BASKET</p>		<p>WIRE BASKET WITH LID</p>	

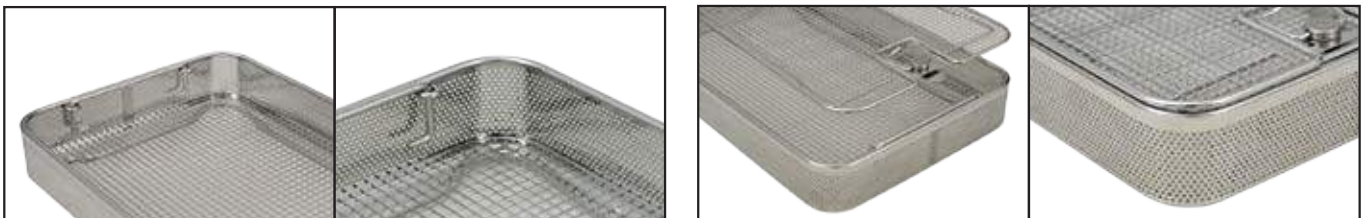

	<p>K3-1501 P 405 x 250 x 50 mm K3-1502 P 405 x 250 x 70 mm K3-1503 P 405 x 250 x 100 mm</p>		<p>K3-1031 P 405 x 250 x 50 mm K3-1032 P 405 x 250 x 70 mm K3-1033 P 405 x 250 x 100 mm</p>
	<p>K3-1034 P ONLY LID, for baskets</p>		
<p>WIRE BASKET</p>		<p>WIRE BASKET WITH LID</p>	



	<p>K2-491 P 255 x 250 x 50 mm K2-492 P 255 x 250 x 70 mm K2-493 P 255 x 250 x 100 mm</p>		<p>K3-1041 P 255 x 250 x 50 mm K3-1042 P 255 x 250 x 70 mm K3-1043 P 255 x 250 x 100 mm</p>
	<p>K3-1045 P ONLY LID, for baskets</p>		
<p>WIRE BASKET</p>		<p>WIRE BASKET WITH LID</p>	

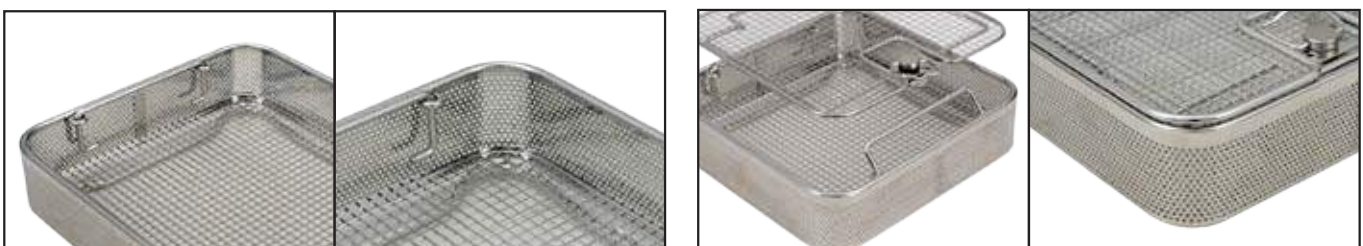



K3-1050 670 x 80 x 52 mm
K3-1051 460 x 80 x 52 mm
K3-1052 290 x 80 x 52 mm
 Endoscope basket

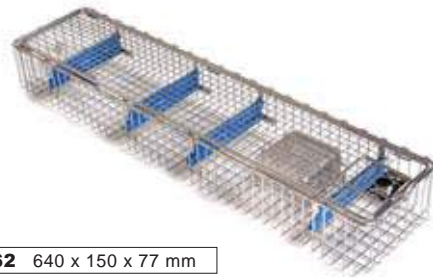

K3-1062 640 x 150 x 77 mm
 Endoscope basket



K3-611 274 x 172 x 43 mm
 Wire basket



K2-993 267 x 125 x 50 mm
 Wire basket



K3-1070 274 x 172 x 73 mm
 Wire basket









K3-1073 267 x 125 x 50 mm
 Wire basket

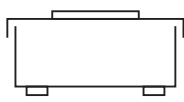
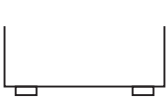
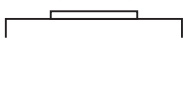

Small fine mesh baskets with lid
Mesh distance = 2 mm x 2 mm

- K3-1100** 30 x 30 x 30 mm
- K3-1101** 40 x 40 x 20 mm
- K3-1102** 40 x 40 x 40 mm
- K3-1103** 60 x 60 x 20 mm
- K3-1104** 60 x 60 x 40 mm
- K3-1105** 60 x 60 x 60 mm
- K3-1106** 80 x 80 x 20 mm
- K3-1107** 80 x 40 x 40 mm
- K3-1108** 80 x 80 x 40 mm
- K3-1109** 80 x 80 x 60 mm
- K3-1110** 80 x 80 x 80 mm
- K3-1111** 100 x 100 x 10 mm
- K3-1112** 120 x 120 x 30 mm
- K3-1113** 120 x 120 x 60 mm
- K3-1114** 120 x 120 x 80 mm
- K3-1115** 240 x 240 x 30 mm
- K3-1116** 240 x 240 x 60 mm
- K3-1117** 240 x 240 x 80 mm
- K3-1118** 240 x 240 x 100 mm



Specifications					
Sizes	h				
	mm	box and lid	box	lid	
1/1  540 x 253 x h	30	K3-720	K3-740		K3-760
	50	K3-721	K3-741		
	70	K3-722	K3-742		
	100	K3-723	K3-743		
1/1  485 x 253 x h	30	K3-724	K3-744		K3-761
	50	K3-725	K3-745		
	70	K3-726	K3-746		
	100	K3-727	K3-747		
3/4  405 x 253 x h	30	K3-728	K3-748		K3-762
	50	K3-729	K3-749		
	70	K3-730	K3-750		
	100	K3-731	K3-751		
1/2  244 x 253 x h	30	K3-732	K3-752		K3-763
	50	K3-733	K3-753		
	70	K3-734	K3-754		
	100	K3-735	K3-755		
Dental  275 x 175 x h	40	K3-736	K3-756		K3-764
	95	K3-737	K3-757		
Small  265 x 125 x h	50	K3-738	K3-758		K3-765





K3-1119
Aluminium basket, with lid
245 x 130 x 55



K3-1120
Aluminium basket, with lid
245 x 130 x 70









K3-1121
Aluminium basket, with lid
245 x 130 x 105 mm

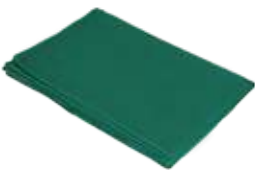

K3-1080 600 x 400 x 150 mm
K3-1081 600 x 400 x 300 mm
 Laundry baskets



K3-1085 600 x 400 x 150 mm
K3-1086 600 x 400 x 300 mm
 Laundry baskets

Drape	Sizes	for MODEL
	<p>K2-1600 130 x 60 cm K2-1601 140 x 100 cm K2-1602 185 x 45 cm K2-1603 180 x 60 cm</p>	<p>1/1 </p>
	<p>K2-1615 140 x 100 cm</p>	<p>3/4 </p>
	<p>K2-1630 90 x 60 cm K2-1631 90 x 80 cm K2-1632 130 x 45 cm K2-1633 130 x 60 cm</p>	<p>1/2 </p>
	<p>K2-1640 90 x 60 cm K2-1641 90 x 80 cm</p>	<p>Flat </p>
	<p>K2-1650 60 x 40 cm</p>	<p>Mini </p>
	<p>K2-1660 60 x 40 cm K2-1661 65 x 65 cm K2-1662 85 x 85 cm</p>	<p>Dental </p>

Container System

Edition 6

AYGUN[®]
SURGICAL INSTRUMENTS CO., INC.

Organize Sanayi Bölgesi 55330
Kutlukent - SAMSUN / TÜRKİYE
Tel : 90 (362) 266 66 80 pbx
Fax : 90 (362) 266 98 44 pbx
E-Mail : aygun@aygun.com

www.aygun.com