

**CHIRURGISCHE
INSTRUMENTE
SURGICAL
INSTRUMENTS
INSTRUMENTS
DE CHIRURGIE
INSTRUMENTOS
PARA CIRUGIA**

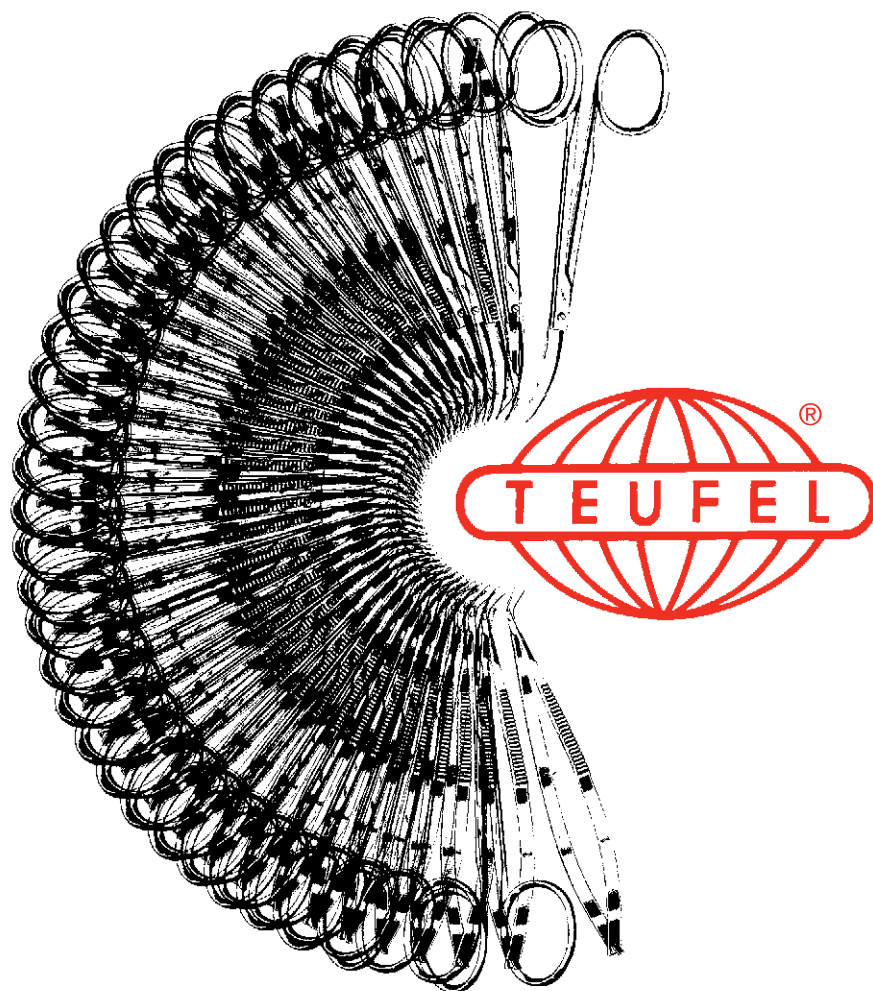

**CHIRURGISCHE
INSTRUMENTE**

**SURGICAL
INSTRUMENTS**

**INSTRUMENTS
DE CHIRURGIE**

**INSTRUMENTOS
PARA CIRUGIA**

**KATALOG
CATALOGUE
CATALOGUE
CATÁLOGO**

**16
2009**

**CARL TEUFEL
GMBH & CO. KG
D-78576 LIPTINGEN
GERMANY**

TUTTLINGER STRASSE 30
PHONE +49 7465 1022
FAX +49 7465 1024
E-Mail office@carl-teufel.de
www.carl-teufel.de



100 % Made in Germany

Unser Familien-Unternehmen ist schon seit dem Jahr 1921 auf die Herstellung hochwertiger chirurgischer Instrumente spezialisiert. Seit nunmehr 88 Jahren wird die Liebe zur Perfektion und zur Qualität von Generation zu Generation weitergegeben.

Wir verwenden nur bestes, von uns geprüfetes Rohmaterial aus deutscher Fertigung. Solide deutsche Handwerksarbeit auf modernsten Fertigungsmaschinen ergeben perfekte Instrumente mit einer langen Lebensdauer. Wir haben ein Qualitätsmanagement-System nach DIN EN ISO 13485. Um unseren hohen Qualitätsstandard garantieren zu können, werden sämtliche Produkte in allen Produktionsstufen und nach Fertigstellung zu 100 % geprüft.

Unser Unternehmen hat die richtige Größe: Groß genug, um auch große Aufgaben rasch erledigen zu können. Und klein und flexibel genug, um auch auf Ihre Sonderwünsche einzugehen oder um nur Einzelstücke zu liefern. Sondermodelle nach Kundenwunsch fertigen wir nach Zeichnung oder Muster. Schicken Sie uns bitte auch Ihre Anfragen über Modelle die nicht in diesem Katalog verzeichnet sind.

100 % Made in Germany

Our family-run business has been specialized in the manufacture of high quality, surgical instruments since 1921. Over the last 88 years our love for perfect quality has been handed down from generation to generation.

We use only the best, German-manufactured raw materials, which are tested by us. Traditional quality craftsmanship, using the most modern production machines, results in perfect instruments with long durability. We have a quality management system according to DIN EN ISO 13485. In order to be able to guarantee our high quality standard, all products are tested in all stages of production and once more 100 % after finishing.

Our company has the right size: big enough to be able to handle large orders. And small and flexible enough, also to respond to your special wishes or to supply just one piece only. We produce special models to meet customer requirements according to drawings or samples. Please also send us your enquiries about models, which are not listed in this catalogue.



100 % Made in Germany

Notre entreprise familiale est spécialisée, depuis 1921 déjà, dans la fabrication d'instruments chirurgicaux de haute qualité. Depuis 88 ans maintenant, l'amour de la perfection et de la qualité se transmet de génération en génération.

Nous n'utilisons que la meilleure matière première de fabrication allemande, que nous contrôlons nous-mêmes. Un travail artisanal sérieux, sur des machines de production très modernes, se traduit par des instruments parfaits d'une grande longévité. Nous disposons d'un système de gestion de la qualité répondant aux normes DIN EN ISO 13485. Pour pouvoir garantir notre haut niveau de qualité, nous contrôlons à 100 % tous nos produits, à tous les stades de la production et après leur achèvement.

Notre entreprise a la taille qui convient: elle est suffisamment grande pour nous permettre d'exécuter aussi, rapidement, les missions d'envergure qui nous sont confiées. Et elle est suffisamment petite et souple pour répondre également à vos souhaits particuliers ou bien pour vous fournir des pièces individuelles. Nous réalisons sur plan ou échantillons les modèles spéciaux qui nous sont demandés par nos clients. Faites-nous parvenir vos demandes pour des modèles qui ne figurent pas dans ce catalogue.

100 % Made in Germany

Desde el año de 1921 nuestra empresa familiar se ha especializado en la fabricación de instrumentos quirúrgicos de la más alta calidad y ya desde hace 88 años estamos transmitiendo de generación en generación nuestro afán por la perfección y la calidad de nuestros productos.

En la manufactura de nuestros productos utilizamos única y exclusivamente materiales alemanes de la mejor calidad, que nosotros mismos probamos antes de utilizarlos. Hacemos el mejor trabajo artesanal usando la maquinaria más moderna lo que reditúa en instrumentos perfectos de gran duración. Hemos implantado un sistema de control de calidad de acuerdo a las normas DIN EN ISO 13485. Todos nuestros productos, tanto durante todas las etapas de su fabricación, como a su finalización son sometidos a las más variadas pruebas garantizando así nuestros altos estándares de calidad.

Nuestra empresa tiene el tamaño adecuado: Es lo suficientemente grande para poder ejecutar trabajos y tareas grandes rápidamente y lo suficientemente pequeña y flexible para hacernos cargo de los deseos y requerimientos específicos de nuestros clientes, estando en condiciones también de fabricar una sola pieza. Podemos fabricar modelos especiales de acuerdo a las especificaciones de nuestros clientes, ya sea basándonos en planos o en muestras que se nos suministren. Gustosamente aceptamos también sus requisiciones de modelos que no aparecen en este catálogo.

Zertifikat

mdc medical device certification GmbH
bescheinigt hiermit, dass das Unternehmen

Carl Teufel GmbH & Co. KG
Tuttlinger Straße 30
78576 Liptingen
Deutschland

im Geltungsbereich

**Entwicklung, Herstellung und Vertrieb von
wieder verwendbaren chirurgischen Instrumenten**

ein

Qualitätsmanagementsystem

eingeführt hat und anwendet.

Ein Audit von mdc hat den Nachweis erbracht,
dass dieses Qualitätsmanagementsystem
die Forderungen der folgenden Norm erfüllt:

DIN EN ISO 13485

**Medizinprodukte – Qualitätsmanagementsysteme –
Anforderungen für regulatorische Zwecke**

(ISO 13485:2003)

Dieses Zertifikat ist gültig bis:	2010-07-01
Zertifikat-Registrier-Nr.:	0058.48.01/1
Stuttgart, den	2006-02-09



Leiter
Zertifizierungsstelle



mdc medical device certification GmbH
Kriegerstraße 6
D-70191 Stuttgart, Germany
Phone: +49-(0)711-253597-0
Fax: +49-(0)711-253597-10
Internet: <http://www.mdc-ce.de>



Akkreditiert durch
Zentralstelle der Länder
für Gesundheitsschutz
bei Arzneimitteln
und Medizinprodukten
ZLG-ZQ-976.00.03-46

Certificate

mdc medical device certification GmbH
certifies that

Carl Teufel GmbH & Co. KG
Tuttlinger Straße 30
78576 Liptingen
Germany

for the scope

**development, manufacturing and distribution of
reusable surgical instruments**

has introduced and applies a

Quality Management System

The mdc audit has proven, that this quality management system
meets all requirements of the following standard

EN ISO 13485

Medical devices – Quality management systems –
Requirements for regulatory purposes

(ISO 13485:2003)

This certificate is valid until:	2010-07-01
Certificate registration no.:	0058.48.01/1
Stuttgart	2006-02-09



Head of
Certification Body



mdc medical device certification GmbH
Kriegerstraße 6
D-70191 Stuttgart, Germany
Phone: +49-(0)711-253597-0
Fax: +49-(0)711-253597-10
Internet: <http://www.mdc-ce.de>



Akkreditiert durch
Zentralstelle der Länder
für Gesundheitsschutz
bei Arzneimitteln
und Medizinprodukten
ZLG-ZQ-976.00.03-46

EC Certificate

mdc medical device certification GmbH

Notified Body 0483
herewith certifies that

**Carl Teufel GmbH & Co. KG
Tuttlinger Straße 30
78576 Liptingen
Germany**

for the scope

tonometer for measuring intra ocular eye pressure

has introduced and applies a

Quality System

for the aspects of manufacture concerned with the conformity
of the products with metrological requirements.

The mdc audit has proven, that this quality system
meets all requirements according to

**Annex V – Section 3
of the Council Directive 93/42/EEC**

of 14 June 1993 concerning medical devices.

The surveillance will be held as specified in Annex V, Section 4.

This certificate is valid until:	2010-07-01
Certificate registration no:	0058.06.01/1
Stuttgart	2006-02-09

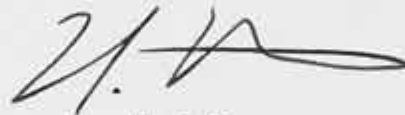

Head of
Certification Body



mdc medical device certification GmbH
Kriegerstraße 6
D-70191 Stuttgart, Germany
Phone: +49-(0)711-253597-0
Fax: +49-(0)711-253597-10
Internet: <http://www.mdc-ce.de>



Akkreditiert durch
Zentralstelle der Länder
für Gesundheitsschutz
bei Arzneimitteln
und Medizinprodukten
ZLG-ZQ-976.94.05



Sperrelevatoren, Wundsperrerr	Eye Specula, retractors	Blepharostats, Ecarteurs	Blefaróstatos, Separadores	15.
Lidhalter	Lid Retractors	Releveurs à Paupières	Retradores para Párpados	16.
Häkchen, IOL-Instrumente	Hooks, IOL-Instruments	Crochets, Instrument p. IOL	Ganchos, Instrument p. IOL	17.
Starmesser und -nadeln, Lanzen, Skalpelle	Cataract Knives, Keratomes, Scalpels	Couteaux lancéolaires et cataract, Bistouries	Cuchillos lanceolares y cataratas, Bisturries	18.
Messer, Diszissionsnadeln, Schaber, Meissel, Kauter, Spateln, Chopper	Knives, Discission Needles, Corneal Scarifiers, Chisel, Spatulas, Chopper	Couteaux, Rugines, Ciseau, Cautère, Kystotomes, Spatules, Chopper	Cuchillos, Legras, Cíncel, Cauterio, Quistotomos Espatulas, Chopper	19.
Fremdkörper- und Doppelinstrumente	Foreign body and double ended instruments	Corps étrangers et instruments doubles	Cuerpos extranos y instrumentos dobles	20.
Löffel, Schlingen, Sonden	Spoons, Loops, Probes	Curettes, Anses, Stylets	Cucharillas, Asas, Estiletes	21.
Klemmen, Stanzen, Dilatatoren	Clamps, Punches, Dilators	Pinces-Clamps, Emporte-Pièces	Pinzas-Clamps, Punzones, Dilatadores	22.
Trephinen, Markierinstrumente	Trephines, Marking Instruments	Trépan, Marqueurs	Trépanos, Marcadores	23.
Irispinzetten	Iris Forceps	Pinces à Iris	Pinzas para Iris	24.
Pinzetten	Forceps	Pinces	Pinzas	25.
Pinzetten	Forceps	Pinces	Pinzas	26.
Nadelhalter	Needleholders	Porte-Aiguilles	Porta-Agujas	27.
Tonometer	Tonometers	Tonomètres	Tonómetros	29.
Klingenhalter	Razor Blade Holders	Porte-Lames	Porta-Hojas	35.
Kanülen	Canulas	Canules	Canulas	36.
Silicon-Teile, Sterilisierbehälter	Silicone-articles, Trays	Articles de silicone, Boites	Articulos de silicona, Cajas para esterilizar	37.
Federscheren, Weckerscheren	Springhandle and Wecker Scissors	Ciseaux «Wecker» etc.	Tijeras „Wecker“ etc.	40.
Micro-Federscheren	Micro-Springhandle Scissors	Ciseaux à Micro-Chirurgie	Tijeras para Micro-Cirugia	42.
Hornhautscheren, rechts und links	Corneal Scissors, left and right	Ciseaux pour la Cornée, gauche et à droite	Tijeras para la Cornea, derecha y izquierda	43.
Hornhautscheren	Corneal scissors	Ciseaux pour la Cornée	Tijeras para la Cornea	44.
Sehnenscheren	Tenotomy Scissors	Ciseaux à ténotomie	Tijeras para Tenotomia	45.
Strabismus- und Sehnen-scheren	Strabismus and Tenotomy Scissors	Ciseaux à Strabisme et ténotomie	Tijeras para Estrabismo y Tenotomia	46.
Augenscheren	Iris Scissors	Ciseaux Oculaires	Tijeras Oculares	47.
Augenscheren	Iris Scissors	Ciseaux Oculaires	Tijeras Oculares	48.
Glaskörperscheren	Vitreous body scissors	Ciseaux à vitre	Tijeras para cuerpo vitréo	49.
Alle Augeninstrumente und -scheren sind, falls nicht anders vermerkt, in natürlicher Größe abgebildet.	All ophthalmic instruments and eye scissors are shown in natural size, unless otherwise stated.	Tous les instruments et ciseaux ophtalmologiques sont, sauf indication contraire, représentés en grandeur naturelle.	Todos los instrumentas y tijeras para oftalmologia son representados en tamaho natural, salvo que esté indicada otra cosa.	



Super Cut Scheren	Super Cut scissors	Ciseaux Super Cut	Tijeras Super Cut	50.
Nasenscheren, Tonsillenscheren	Nasal scissors, Tonsil scissors	Ciseaux pour le nez, Ciseaux pour les amygdales	Tijeras nasales, Tijeras para amígdalas	53.
Metzenbaum / Präparierscheren	Metzenbaum / Dissecting scissors	Metzenbaum / Ciseaux a dissection	Metzenbaum / Tijeras para preparaciones	54.
Chirurgische Spezialscheren, Cardiovascularscheren	Operating scissors, Cardiovascular scissors, Dissecting scissors	Ciseaux à chirurgie, Ciseaux vasculaires, Ciseaux à disséquer	Tijeras para cirugía, Tijeras vascular, Tijeras de dissezione	55.
Gynäkologische Scheren	Gynecological scissors	Ciseaux pour gynécologie	Tijeras para ginecologia	56.
Mayoscheren	Mayo scissors	Ciseaux à chirurgie	Tijeras para cirugía	57.
Chirurgische Scheren, Scheren für die plastische Chirurgie	Surgical scissors, Scissors for plastic surgery	Ciseaux à chirurgie, Ciseaux pour chirurgie plastique	Tijeras para cirugía, Tijeras para cirugía plástica	58.
Fadenscheren, Verbandscheren	Stitch scissors, Bandage scissors	Ciseaux à ligatures, Ciseaux à pansements	Tijeras para ligadura, Tijeras para vendajes	59.
Ausführliches Inhaltsverzeichnis am Ende des Katalogs.	Detailed index at the end of the catalogue.	Table des Matières détaillée à la fin du catalogue.	Un índice detallado se encuentra en el fin del catálogo.	

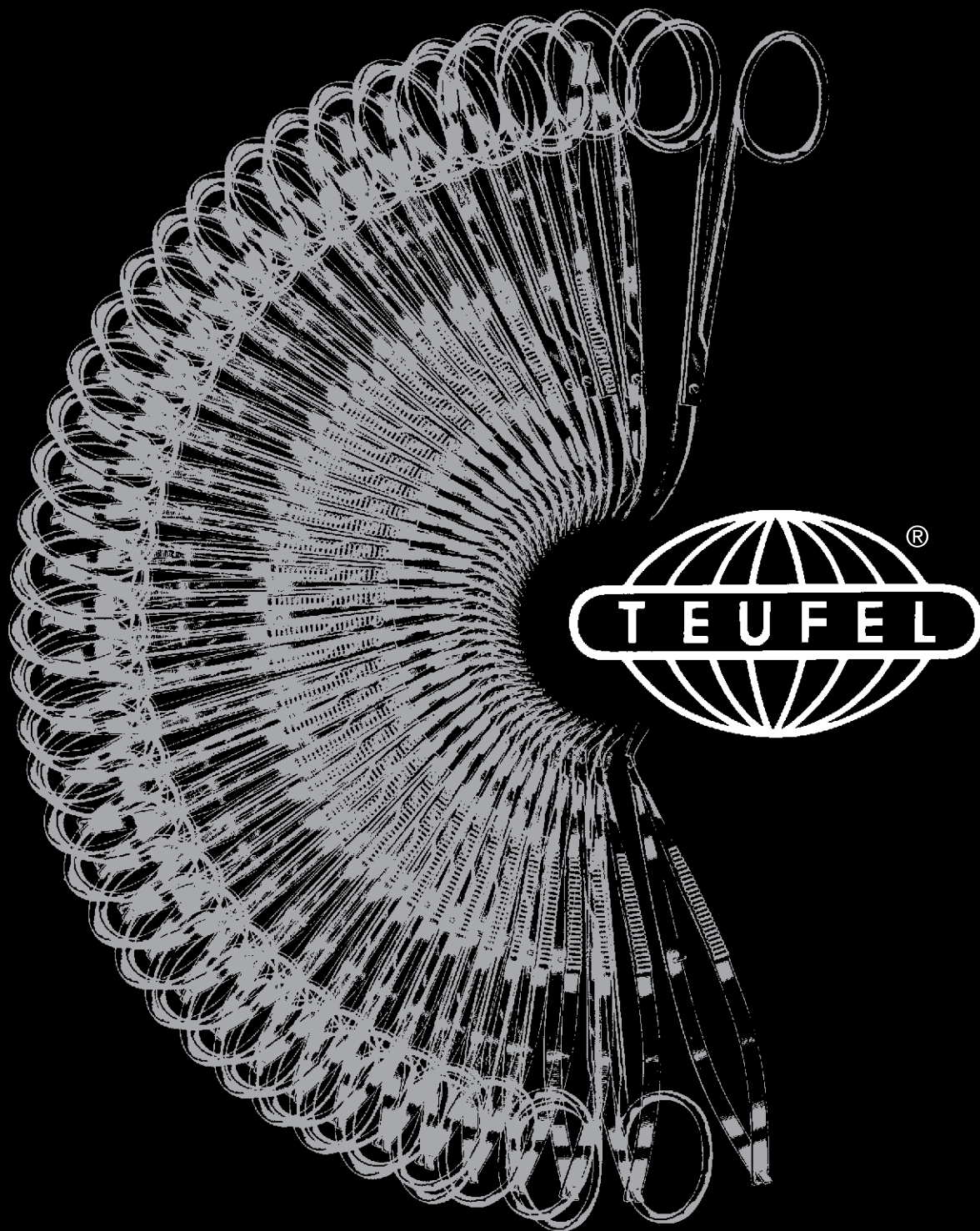

**CHIRURGISCHE
AUGENINSTRUMENTE
OPHTHALMOLOGICAL
SURGICAL INSTRUMENTS
INSTRUMENTS DE
CHIRURGIE OCULAIRE
INSTRUMENTOS PARA
CIRUGIA OFTALMICA**

**1402-15
LIEBERMAN**

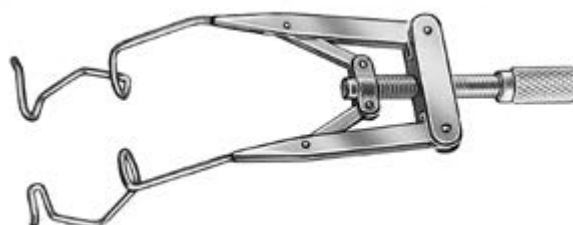

**1403-15
LIEBERMAN**

ohne Spülung
without irrigation
sans irrigation
sin irrigación



**1413-15
LIEBERMAN**

mit Spülung
with irrigation
avec irrigation
con irrigación

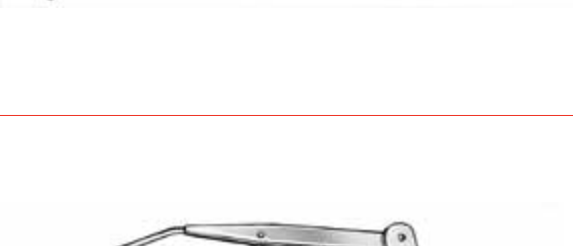

**1404-15
LIEBERMAN**

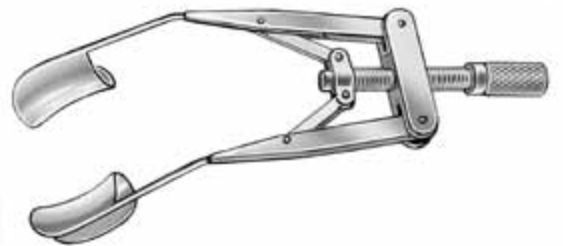

**1405-15
LIEBERMAN**

Umkehrbar
Reversible
Réversible
Reversible



SPERRELEVATOREN
EYE SPECULA



BLÉPHAROSTATS
BLEFARÓSTATOS

1500-16
MELLINGER

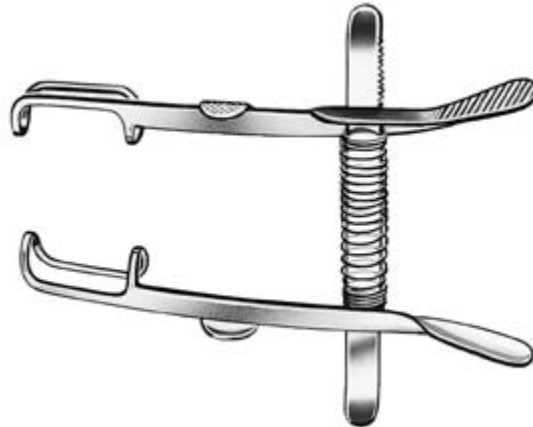

1503-16
MELLINGER-BEARD

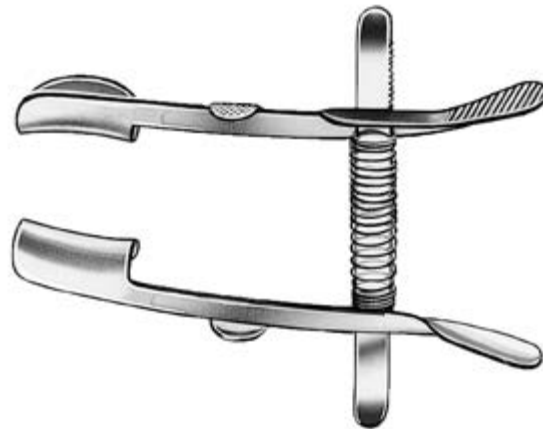

1504-15
WEISS

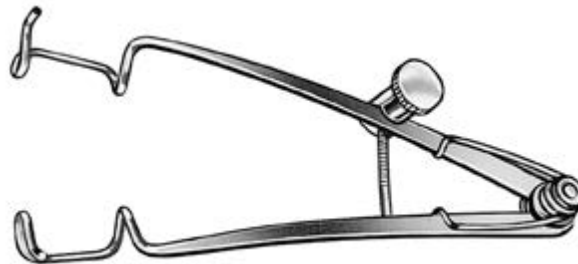

1505-15
LANCASTER

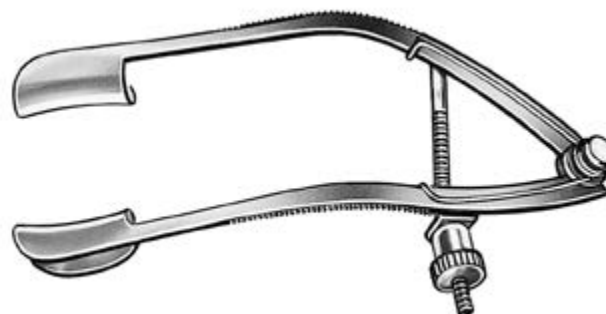

1507-16
GRAEFE

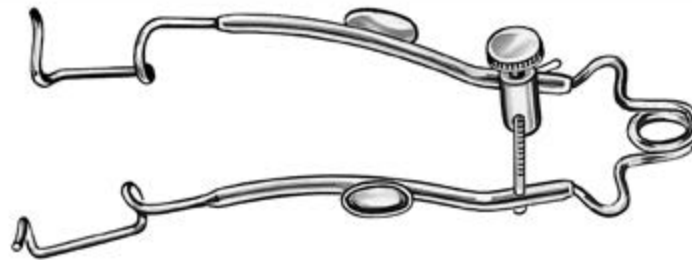

1511-14
CASTROVIEJO

klein
small
petit
pequeño



1512-16
CASTROVIEJO

groß
large
grand
grande



1515-02
SAUER

2 mm

1515-04
SAUER

4 mm

1515-06
SAUER

6 mm

1515-08
SAUER

8 mm

1515-12
SAUER

12 mm (normal)



1515-12

1517-14
WEISS

klein
small
petit
pequeño

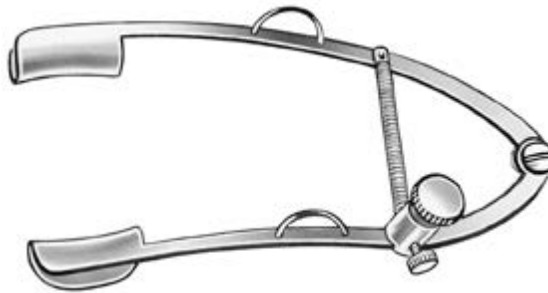

1518-14
WEISS

klein
small
petit
pequeño

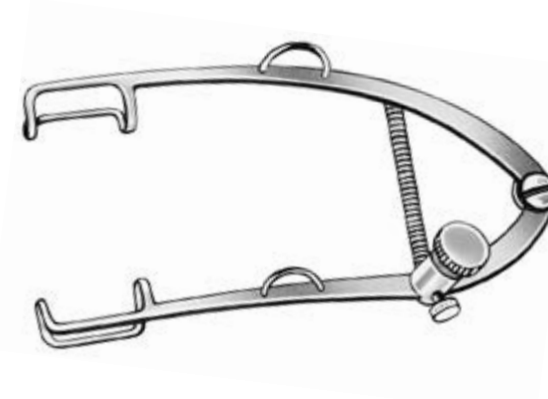

1519-18
WEISS

groß
large
grand
grande

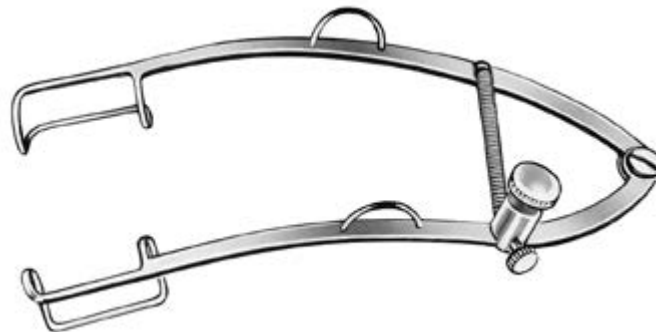

1520-18
WEISS

groß
large
grand
grande

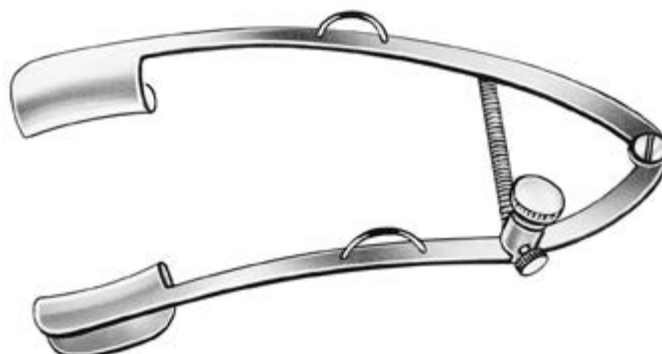

1521-15
CLARK

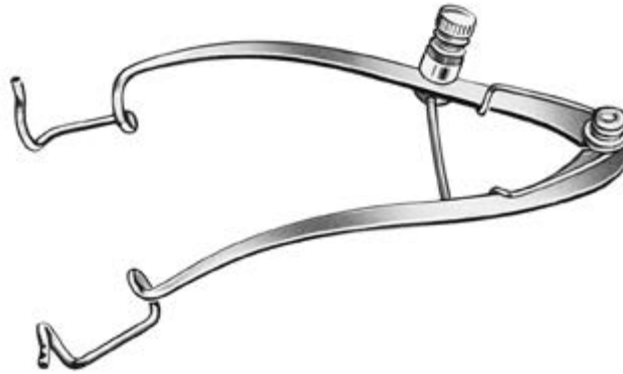

1522-12
MURDOCK
für Kinder
for children
pour enfants
para niños

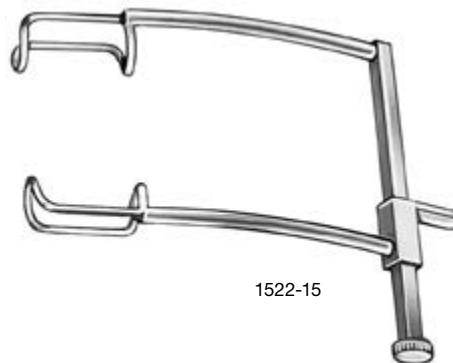

1522-15
MURDOCK
für Erwachsene
for adults
pour adultes
para adultos

1522-15

1523-15
MURDOCK
mit Feststellschraube
with screw lock
avec vis de serrage
con fijación de rosca

1525-14
MAUMENEE-PARK

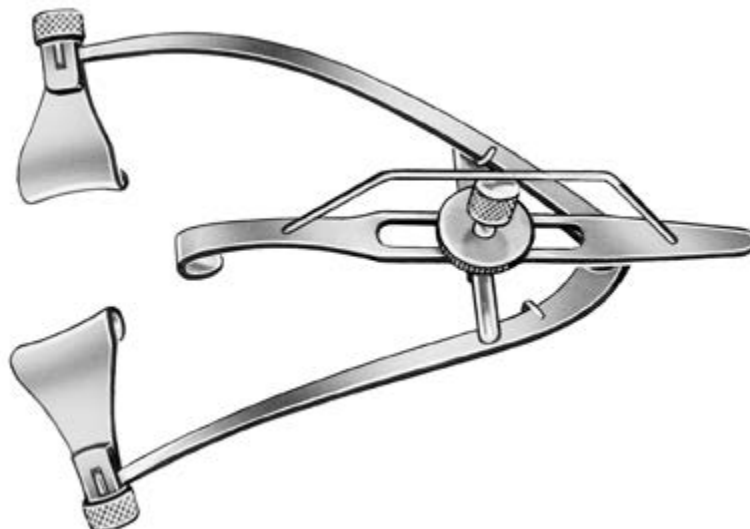

1526-15
PARK-GUYTON

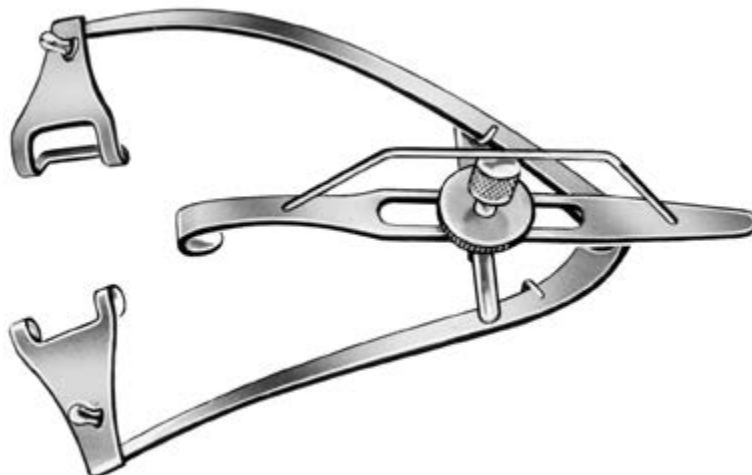

1528-11
BANGERTER

für Kinder
for children
pour enfants
para niños

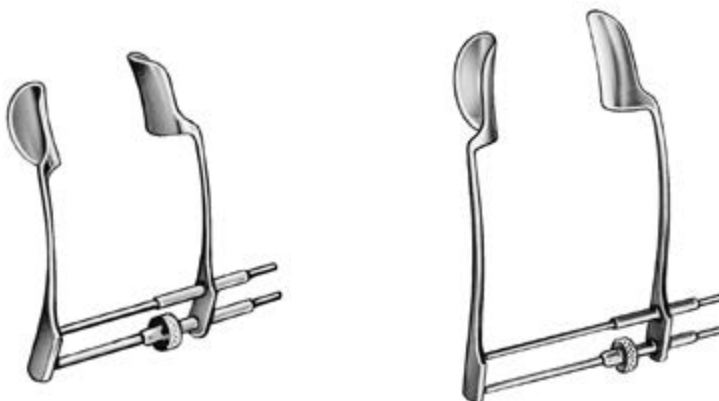

1528-15
BANGERTER

für Erwachsene
for adults
pour adultes
para adultos

1529-12
BARRAQUER

für Kinder
for children
pour enfants
para niños



1529-15
BARRAQUER

für Erwachsene
for adults
pour adultes
para adultos

1530-15
BARRAQUER

für Erwachsene, normales Modell
for adults, normal model
pour adultes, modèle normal
para adultos, modelo normal



1530H15
BARRAQUER

für Erwachsene, extra stabil
for adults, strong wire
pour adultes, en fil métallique épais
para adultos, alambre fuerte

SPERRELEVATOREN**EYE SPECULA****BLÉPHAROSTATS****BLEFARÓSTATOS**

1531-04
BARRAQUER
für Säuglinge
for infants
pour nourrissons
para lactantes



1531-08
BARRAQUER
für Kinder
for children
pour enfants
para niños



1531-12
BARRAQUER
für Kinder
for children
pour enfants
para niños



1532-05
BARRAQUER
für Säuglinge
for infants
pour nourrissons
para lactantes



1532-10
BARRAQUER
für Kinder
for children
pour enfants
para niños



1532-14
BARRAQUER
für Erwachsene
for adults
pour adultes
para adultos

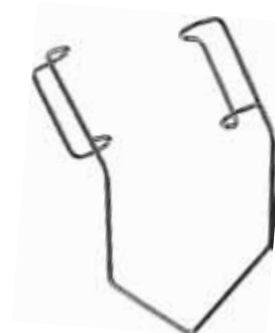

1533-11
BARRAQUER-OOSTERHUIS
für Kinder
for children
pour enfants
para niños



1533-15
BARRAQUER-OOSTERHUIS
für Erwachsene
for adults
pour adultes
para adultos



1538-15
BARRAQUER-OOSTERHUIS



SPERRELEVATOREN**EYE SPECULA****BLÉPHAROSTATS****BLEFARÓSTATOS**

**1536-12
SCHOTT**

für Kinder
for children
pour enfants
para niños

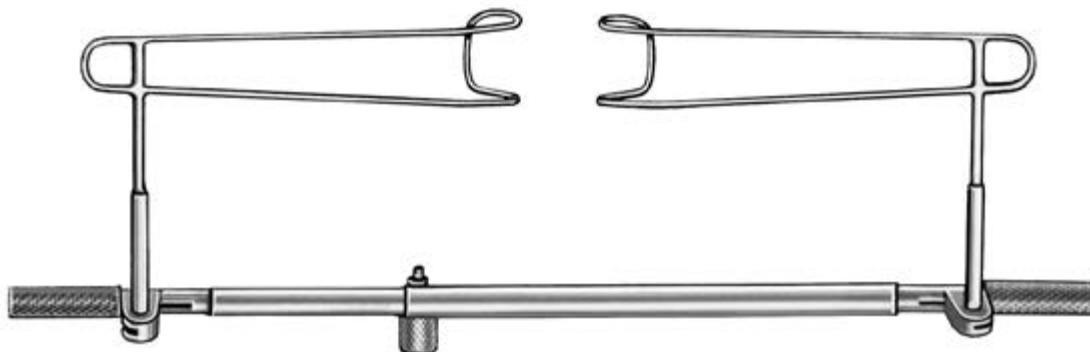
**1536-15
SCHOTT**

für Erwachsene
for adults
pour adultes
para adultos

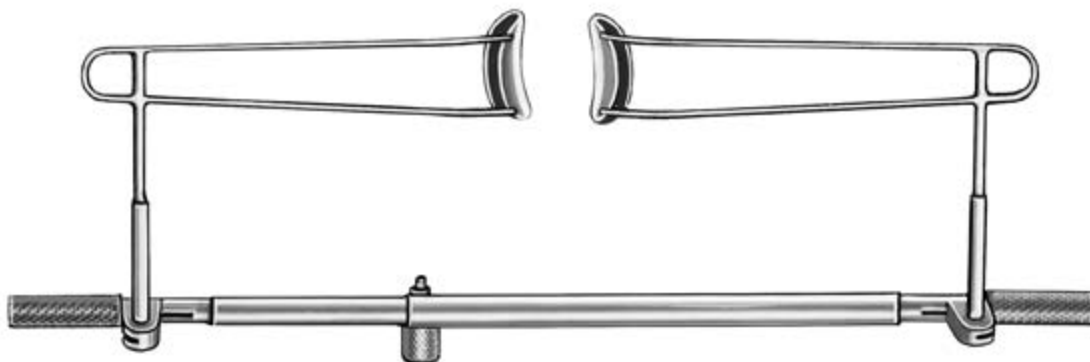
**1537-12
SCHOTT**

für Kinder
for children
pour enfants
para niños

**1537-15
SCHOTT**

für Erwachsene
for adults
pour adultes
para adultos

**1540-05
COOK**

für Neugeborene
for newborn babies
pour nouveaux nés
para recién nacidos

**1540-08
COOK**

für Säuglinge
for infants
pour nourrissons
para lactantes

**1540-11
COOK**

für Kinder
for children
pour enfants
para niños

**1540-15
COOK**

für Erwachsene
for adults
pour adultes
para adultos



SPERRELEVATOREN
EYE SPECULA



BLÉPHAROSTATS
BLEFARÓSTATOS

1543-11
WILLIAMS

klein
small
petit
pequeño

1543-15
WILLIAMS

groß
large
grand
grande

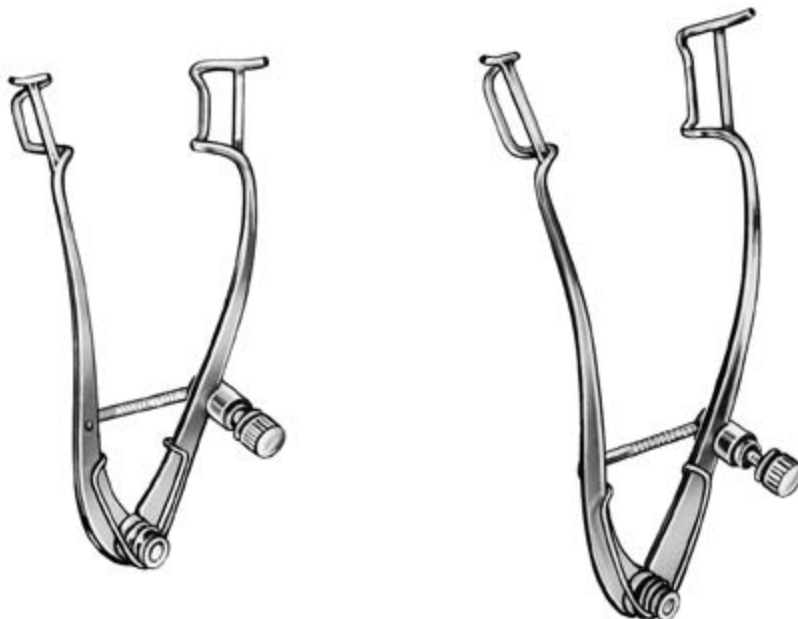

1544-15
KRATZ-BARRAQUER
temporal

1544N15
KRATZ-BARRAQUER
nasal



1547-15
temporal



SPERRELEVATOREN
EYE SPECULA



BLÉPHAROSTATS
BLEFARÓSTATOS

1548-15
McINTYRE

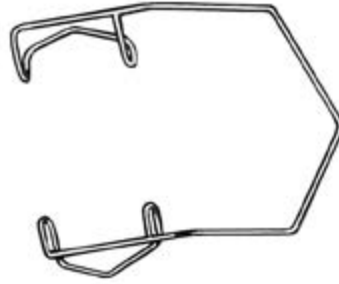

1549-15
McINTYRE



1550-08
ALFONSO



WUNDSPERRER
RETRACTORS

ÉCARTEURS
SEPARADORES

1551-11
MUELLER



1552-06
AGRICOLA



1553-10
STEVENSON



LIDHALTER
LID RETRACTORS



RELEVEURS À PAUPIÈRES
RETRACTORES PARA PÁRPADOS

1651-05
DESMARRES 5 mm

1651-08
DESMARRES 8 mm
(CONWAY)

1651-11
DESMARRES 11 mm

1651-14
DESMARRES 14 mm

1651-17
DESMARRES 17 mm

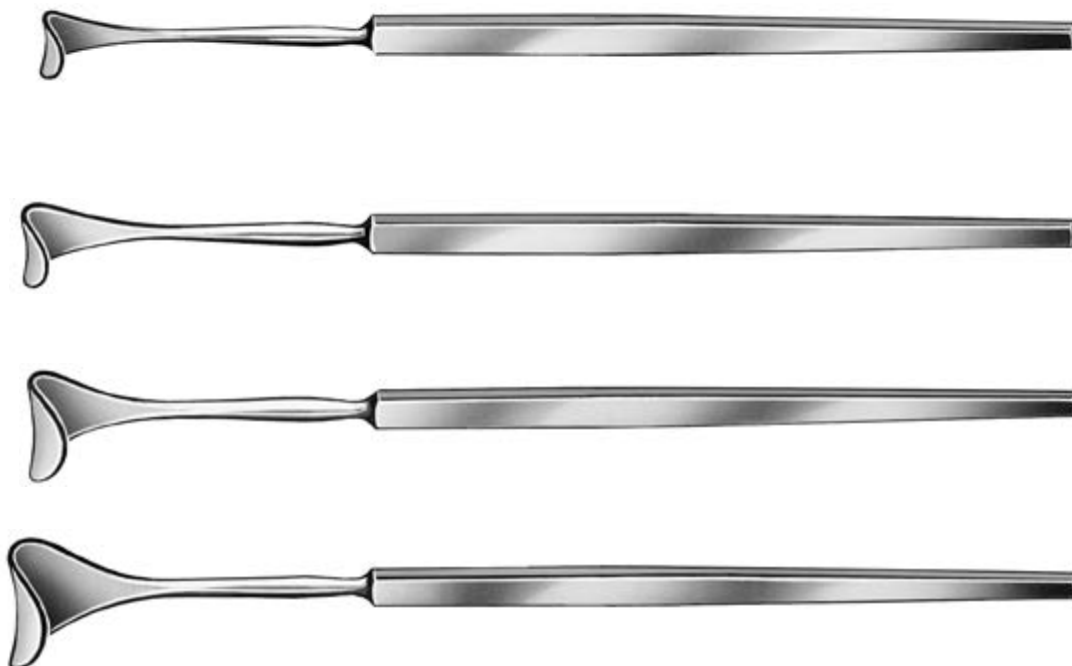

1655-13
SCHEPENS



1664-10
JAFJE
für Kinder
for children
pour enfants
para niños

1664-15
JAFJE
für Erwachsene
for adults
pour adultes
para adultos



1666-15
TENNANT



1670-11
JAEGER



HÄKCHEN
HOOKS



CROCHETS
GANCHOS

1700-00 scharf
TYRELL sharp
pointu
agudo



1701-00 stumpf
GRAEFE blunt
mousse
roma



1701-01 stumpf
BONNER MODELL blunt
mousse
roma



2 : 1 vergrößert, enlarged, agrandi, agrandando

1701-20 superfein, stumpf
BONNER MODELL extremely delicate, blunt
extra fine, mousse
delicadísima, roma



1702-00 scharf
GUTHRIE sharp
pointu
agudo



1703-00 scharf
GUTHRIE sharp
pointu
agudo



1704-00 scharf
ROLLET sharp
pointu
agudo

1704-03 stumpf
ROLLET blunt
mousse
roma



1705-00 scharf
AUBARET sharp
pointu
agudo



1708-00 scharf
AXENFELD sharp
pointu
agudo

1709-00 stumpf
AXENFELD blunt
mousse
roma



1710-00 scharf
AXENFELD (KNAPP) sharp
pointu
agudo

1711-00 stumpf
AXENFELD (KNAPP) blunt
mousse
roma



**HÄKCHEN
HOOKS**



**CROCHETS
GANCHOS**

**1714-03
CLAYMAN**



vergrößert, enlarged, agrandi, agrandando



**1716-10
JAEGER**



**1716-20
JAEGER**



**1717-10
GRAEFE**



**1717-20
GRAEFE**



**1717-30
GRAEFE**



**1718-20
BONNER MODELL**



**1719-00
JAMESON**



**1719-10
JAMESON**



**1721-00
GREEN**



HÄKCHEN
HOOKS



CROCHETS
GANCHOS

1722-00
STEVENS



1723-06
HELVESTON



1724-00
GASS



1730-00
ARRUGA

rechts
right
à droite
derecha



1731-00
ARRUGA

links
left
à gauche
izquierda



1735-02
SINSKEY
0,2 mm Ø



vergrößert, enlarged, agrandi, agrandando

1736-02
CLAYMAN
0,2 mm Ø



vergrößert, enlarged, agrandi, agrandando

1738-00
KUGLEN



1739-00
KUGLEN



vergrößert, enlarged, agrandi, agrandando

1740-00
DARDENNE



1765-60
KAGAWA
Phaco Chopper
60°



1765-90
KAGAWA
Phaco Chopper
90°

1767-50
JAFFE
Spatel, 0,50 mm
Spatula, 0,50 mm
Spatule, 0,50 mm
Espátula, 0,50 mm



1770-00
KNOLLE
Irishäkchen, stumpf
Irish hook, blunt
Crochet à iris, mousse
Gancho para iris, romo



1771-00
JAFFE-KNOLLE
Irishäkchen, stumpf
Irish hook, blunt
Crochet à iris, mousse
Gancho para iris, romo



1775-15
FENZL
Häkchen, 0,15 mm
Hook, 0,15 mm
Crochet, 0,15 mm
Gancho, 0,15 mm



1776-00
KUGELN
Häkchen
Hook
Crochet
Gancho



1777-20
SINSKEY
Häkchen, 0,20 mm
Hook, 0,20 mm
Crochet, 0,20 mm
Gancho, 0,20 mm



1778-20
SINSKEY
Häkchen, 0,20 mm
Hook, 0,20 mm
Crochet, 0,20 mm
Gancho, 0,20 mm



LESTER

Häkchen, 0,25 mm
Hook, 0,25 mm
Crochet, 0,25 mm
Gancho, 0,25 mm

1779-25

gerade
straight
droit
recto



1779-50

gewinkelt
angled
angulaire
angulado



1779-75

gewinkelt und gebogen
vaulted shank
angulaire et courbé
angulado y curvo



1781-00

NEUHANN

Häkchen und Kernspalter
Hook and Nucleus Cracker
Crochet et „Nucleus Cracker“
Gancho y fragmentador de núcleo



1781-01

NEUHANN

Push-Pull Irishhäkchen und Kernspalter
Push-Pull Iris Hook and Nucleus Cracker
Push-Pull crochet et „Nucleus Cracker“
Push-pull gancho y fragmentador de núcleo



1782-00

NEUHANN

Häkchen
Hook
Crochet
Gancho

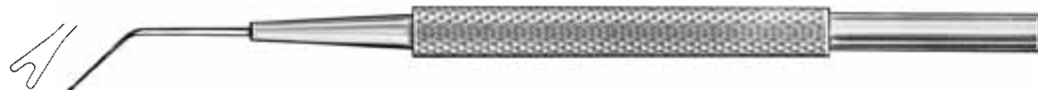

**1783-00**
BECHERT

Linsenrotierer, Original Modell
Lens nucleus rotator, original model
Crochet à lentilles, modèle original
Rotador de núcleo, modelo original

**1783-01**
BECHERT

Linsenrotierer, Gabel 90° gedreht
Lens nucleus rotator, Fork 90° twisted
Crochet à lentilles, fourche 90° tournée
Rotador de núcleo, horquilla con torsión de 90°

**1783-02**
BECHERT

Linsenrotierer, gerade
Lens nucleus rotator, straight
Crochet à lentilles, droit
Rotador de núcleo, recto

**1784-50**
CLAYMAN

Linsenrotierer
Lens nucleus rotator
Crochet à lentilles
Gancho para lentes

**1785-00**
KOCH

Phakosplitter
Phaco Splitter
Couteau de phaco
Disecccionador para faco

**1786-00**
ROSEN

Phakosplitter
Phaco Splitter
Couteau de phaco
Disecccionador para faco

**1787-00**
GRAETHER

Kragenknopf Kapselpolierer
Collar button capsula polisher
Polissoir capsulaire
Pulidor de cápsula





1790-20

JACOBI

Repositionshäkchen, 0,20 mm
Reposition hook, 0,20 mm
Crochet à réposition, 0,20 mm
Gancho de reposición, 0,20 mm



1790-30

JACOBI

Repositionshäkchen, 0,30 mm
Reposition hook, 0,30 mm
Crochet à réposition, 0,30 mm
Gancho de reposición, 0,30 mm

1791-01

LIEBERMAN

Micro Finger
rechts
right
à droite
derecha



1791-02

LIEBERMAN

Micro Finger
links
left
à gauche
izquierda



1792-01

CHANG

Phaco Chopper



1793-00

NAGAHARA

Linsenspatel
Lens spatula
Spatule pour cristallin
Espátula para cristalino



1794-00

FUKASAKU

„snap & split“
Häkchen
Hook
Crochet
Gancho



1795-00

DRYSDALE

Kernmanipulator
Nucleus rotator
Crochet pour manipulation du noyau
Rotador de núcleo





1796-01

PISACANO

Kernmanipulator, horizontal
Nucleus rotator, horizontal
Crochet pour manipulation du noyau, horizontal
Rotador de núcleo, horizontal



1796-02

PISACANO

Kernmanipulator, vertikal
Nucleus rotator, vertical
Crochet pour manipulation du noyau, vertical
Rotador de núcleo, vertical



1798-00

NAGAHARA

Nucleus Chopper



HAEFLIGER

Micro-Manipulator für Phako
Micro-Manipulator for Phaco
Micro-Manipulateur à Phaco-emulsification
Micromanipulador para faco

1799-00

stumpf, rechts
blunt, right
émoussée, à droite
roma, derecho



1799-01

stumpf, links
blunt, left
émoussée, à gauche
roma, izquierdo



1799-30

scharf, rechts
sharp, right
tranchant, à droite
afilado, derecho



1799-31

scharf, links
sharp, left
tranchant, à gauche
afilado, izquierdo



SKALPELLE
SCALPELS



BISTOURIS
BISTURÍES

1800-13
1800-20



1800-20

1802-13
1802-16
1802-18



1802-18



1810-02
Diamant mit einer Schneide
Diamond with one cutting edge
Diamant à un tranchant
Diamante con un corte



vergrößert
enlarged
agrandi
agrandando

1811-02
Diamant mit 2 Schneiden
Diamond with 2 cutting edges
Diamant à 2 tranchants
Diamante con 2 cortes



vergrößert
enlarged
agrandi
agrandando

Messlehren auf Seite 23.04
Measuring gauges see page 23.04
Instruments de mesure voir page 23.04
Patrón de medición véase página 23.04

1825-15
TOOKE



1830-04
1830-06
1830-10
GRAEFE



1830-10

1838-00
PATON



STARMESSER
CATARACT KNIVES



COUTEAUX À CATARACTE
CUCHILLOS PARA CATARATAS

1840-25
GRAEFE

25 mm x 1,5 mm



1840-30
GRAEFE

30 mm x 2,0 mm

SATOMESSER
SATO KNIVES

COUTEAUX SATO
CUCHILLOS SATO

1854-03
DARDENNE



vergrößert, enlarged, agrandi, agrandando



1855-00



1881-10
JAEGER
30°



1881-20
JAEGER
30°



1893-21 (2,1 mm)
1893-28 (2,8 mm)
1893-32 (3,2 mm)
1893-35 (3,5 mm)

Phakolanzen
Phako Keratomes
Keratomes lanc. de phako
Punta de faco



1894-00
MODELL HAMBURG



HYDRO CHOPPER
HYDRO CHOPPER



HYDRO CHOPPER
HYDRO CHOPPER

1900-15
KOCH
Phaco-Chopper



1900-55
ROSEN
Irrigating Nucleus Chopper
Dual side ports, 20 gauche



1900-75
ROSEN
Hydro Chopper
End opening 0,95 mm O. D.



1900-81
NAGAHARA
Hydro Chopper
Wedge shaped edge, rounded tip
End opening 0,95 mm O. D.



1900-83
NAGAHARA
Hydro Chopper
60° wedge shaped edge, rounded tip
End opening 0,95 mm O. D.





1913-17
WHEELER

Diszissionsmesser
Discission knife
Couteaux à discision
Cuchillos para discisión



1914-00
JÄCKER

Fadenlösmesser
for removal of sutures
pour couper les fils
para cortar suturas



1915-10
KUHNT

Schaber
Corneal Scarifiers
Rugines pour la cornée
Legras para la córnea



1916-20
KUHNT



1920-45
MODELL HEIDELBERG

Rasparatorium
Raspatory
Rugine
Legra



1925-45
MODELL HEIDELBERG

Elevatorium
Elevator
Releveur
Elevador



1926-00
FREER

Elevatorium
Elevator
Releveur
Elevador



IRISMESSER
IRIS KNIVES



COUTEAUX POUR L'IRIS
CUCHILLOS PARA IRIS

1930-30
ZIEGLER
3 mm



1930-45
ZIEGLER
4,5 mm

1932-70
KNAPP



MEISSEL
CHISEL

RUGINE
CINCEL

1945-50
WEST



1946-50
WEST



1950-00
ROLLET



KAUTER
CAUTERY

CAUTÈRE
CAUTERIO

1955-00
WADSWORTH-TODD



**KYSTOTOME
CYSTOTOMES**



**KYSTOTOMES
QUISTOTOMOS**

**1958-00
GRAEFE**



**1959-00
GRAEFE**



**1960-00
GRAEFE**



**SPATEL
SPATULAS**

**SPATULES
ESPATULAS**

**1965-00
KREISSIG**
Kombideller
Localizer
Localisateur
Localizador



**1972-00
KIMURA**
Platin



1975-00
Keratoplastiksiebpatel
Keratoplasty Spatula
Spatule pour kératoplastie
Espátula para queratoplastia



**1976-00
MODELL GIESSEN**



**1978-30
MODELL FRANKFURT**



**1979-00
TROUTMAN**



**SPATEL
SPATULAS**



**SPATULES
ESPATULAS**

**1980-10
WECKER**
rostsicher
stainless
inox

**1982-10
WECKER**
Silber 800
Sterling silver
Argent
Plata



**1980-20
WECKER**



**1983-06
BANGERTER**
6 mm



**1983-08
BANGERTER**
8 mm

nicht abgebildet, not illustrated, sans illustration, no ilustrado

**1983-10
BANGERTER**
10 mm



**1983-12
BANGERTER**
12 mm



**1984-10 = 1,0 mm
1984-15 = 1,5 mm
1984-20 = 2,0 mm
BANGERTER**

Irisspatel
Iris Spatula
Spatule à iris
Espátula para iris



**1985-10
ELSCHNIG**



**1986-10
CASTROVIEJO**



**1986-15
CASTROVIEJO**



**1988-00
TROUTMAN**
matt



1989-05
0,50 mm



KOCH
Nucleus spatula

1990-01



1990-02



2002-00
MEYER



2003-00
SCHWEIZER MODELL



2010-00

gerade
straight
droit
recto



2011-00

gebogen
curved
courbe
curvo



2021-00
ALVIS



2022-00
PLANGE



2023-00
PLANGE



2025-00



Schlinge und Magnet
Loop and magnetic probe
Anse et aimant
Asa e imán





2031-00



2032-00

normal

2032-10

extra fein
extremely delicate
extra fine
delicadísima



2033-00

PLANGE



2036-00



2037-00

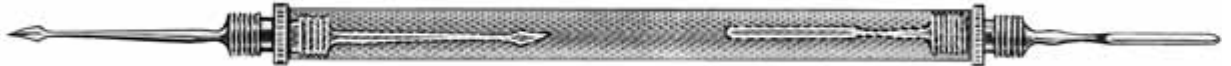

2044-00



2045-00

WHEELER



2050-00

GREEN



2055-25 (0,25 mm)

2055-50 (0,50 mm)

CASTROVIEJO



LÖFFEL
SPOONS



CURETTES
CUCHARILLAS

2104-10
DAVIEL



2104-20
DAVIEL



2107-10
HERBA



2107-20
HERBA



2107-30
HERBA



MEYHÖFER

- 2108-05** 0,5 mm Ø
- 2108-10** 1,0 mm Ø
- 2108-15** 1,5 mm Ø
- 2108-20** 2,0 mm Ø
- 2108-25** 2,5 mm Ø
- 2108-30** 3,0 mm Ø



2111-00
WELLS



- BUNGE**
- 2122-06** 6 mm Ø
 - 2122-08** 8 mm Ø
 - 2122-10** 10 mm Ø
 - 2122-12** 12 mm Ø



2132-00
AXENFELD



SCHLINGEN
LOOPS



ANSES
ASAS

2150-10
WEBER



2150-20
WEBER



2153-00
ARLT



2154-00
SNELLEN



SONDEN
PROBES



STYLETS
ESTILETES

Angabe der 6-stelligen
Katalognummer genügt.

The indication of the 6-digit
catalog number is sufficient.

L'indication du numéro de
catalogue à 6 chiffres suffit.

La indicación del número de
catálogo de 6 cifras es suficiente.

-04 = Fig. 0000/000 = 0,6/0,7 mm Ø
-03 = 000/00 = 0,7/0,8 mm Ø
-02 = 00/0 = 0,8/0,9 mm Ø
-01 = 0/1 = 0,9/1,0 mm Ø
-12 = 1/2 = 1,0/1,2 mm Ø
-23 = 2/3 = 1,2/1,3 mm Ø
-34 = 3/4 = 1,3/1,4 mm Ø
-45 = 4/5 = 1,4/1,5 mm Ø
-56 = 5/6 = 1,5/1,6 mm Ø
-67 = 6/7 = 1,6/1,8 mm Ø
-78 = 7/8 = 1,8/2,0 mm Ø
-99 = 1 Satz mit 5 oder 6 Stück
-99 = 1 set with 5 or 6 pieces
-99 = le jeu de 5 ou 6
-99 = 1 juego de 5 ó 6 piezas

BOWMAN

Neusilber	Nirosta
German silver	Stainless steel
Ruolz	Acier inoxydable
Metal blanco	Acero inoxidable

2180-04	2182-04
2180-03	
2180-02	2182-02
2180-01	
2180-12	2182-12
2180-23	
2180-34	2182-34
2180-45	
2180-56	2182-56
2180-67	
2180-78	



BOWMAN

Silber 800
Sterling silver
Argent
Plata

2181-04 = Fig.	0000/000
2181-03 = Fig.	000/00
2181-02 = Fig.	00/0
2181-01 = Fig.	0/1
2181-12 = Fig.	1/2
2181-23 = Fig.	2/3
2181-34 = Fig.	3/4
2181-45 = Fig.	4/5
2181-56 = Fig.	5/6
2181-67 = Fig.	6/7
2181-78 = Fig.	7/8



BOWMAN

Neusilber	Nirosta
German silver	Stainless steel
Ruolz	Acier inoxydable
Metal blanco	Acero inoxidable

2184-02	2186-02
2184-01	
2184-12	2186-12
2184-23	
2184-34	2186-34
2184-45	
2184-56	2186-56
2184-67	
2184-78	



BOWMAN

Silber 800
Sterling silver
Argent
Plata

2185-02 = Fig.	00/0
2185-01 = Fig.	0/1
2185-12 = Fig.	1/2
2185-23 = Fig.	2/3
2185-34 = Fig.	3/4
2185-45 = Fig.	4/5
2185-56 = Fig.	5/6
2185-67 = Fig.	6/7
2185-78 = Fig.	7/8



**2190-10
HARMS**

Trabekularsonde, rechts
Trabeculotomy probe, right
Trabéculotome, côté droit
Trabeculótomo, derecho

**2190-20
HARMS**

Trabekularsonde, links
Trabeculotomy probe, left
Trabéculotome, côté gauche
Trabeculótomo, izquierdo



**2191-10
MACKENSEN**

Trabekularsonde, rechts
Trabeculotomy probe, right
Trabéculotome, côté droit
Trabeculótomo, derecho

**2191-20
MACKENSEN**

Trabekularsonde, links
Trabeculotomy probe, left
Trabéculotome, côté gauche
Trabeculótomo, izquierdo



**2196-60
WORST**

Pigtail

mit Haken
with hook
avec crochet
ganchudo



**2197-00
WORST**

Pigtail

mit Öse
with hole
avec anneau
con ojete



DILATATOREN
DILATORS



DILATATEURS
DILATADORES

2200-10
WILDER 4 mm Ø
(NETTLESHIP)



2200-20
WILDER 4 mm Ø
(NETTLESHIP)



2200-30
WILDER 4 mm Ø
(NETTLESHIP)



2201-10
WILDER 3 mm Ø



2201-20
WILDER 3 mm Ø



2201-30
WILDER 3 mm Ø



2202-00
CASTROVIEJO



2203-00
MULDOON



2206-00
RUEDEMANN
für Säuglinge
for infants
pour nourrissons
para lactantes



2207-00
MODELL GIESSEN



GEFÄSSKLEMMEN
SERREFINES

SERRE-FINES
SERRA-FINAS

2260-35
DIEFFENBACH
3,8 cm



2261-35
DIEFFENBACH
3,8 cm



2265-95
BACKHAUS

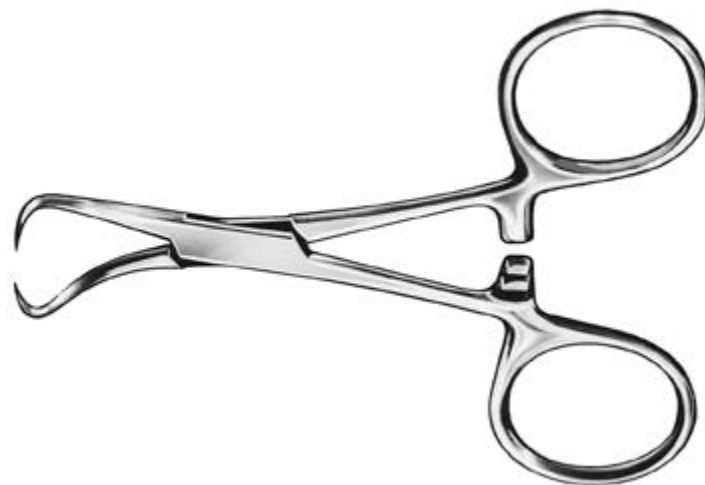

2267-50
JONES



2272-10
HARTMANN-MOSQUITO

gerade
straight
droit
recto
10 cm

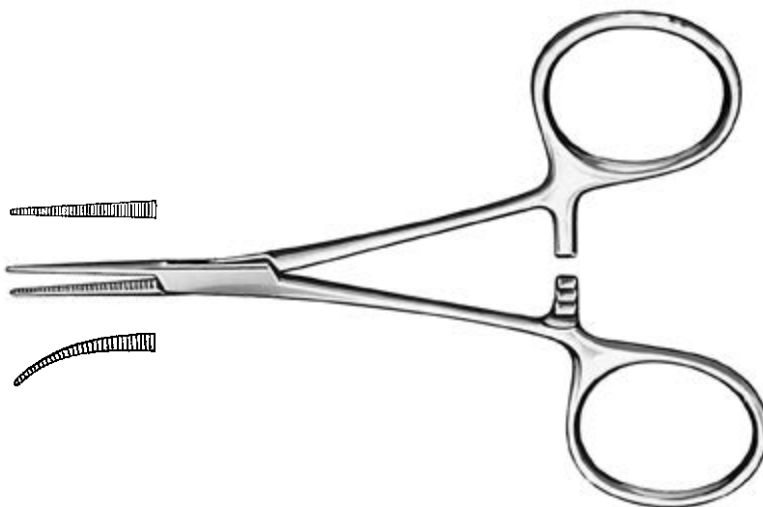

2273-10
HARTMANN-MOSQUITO

gebogen
curved
courbe
curvo
10 cm



2274-12
HALSTED-MOSQUITO

gerade
straight
droit
recto
12,5 cm

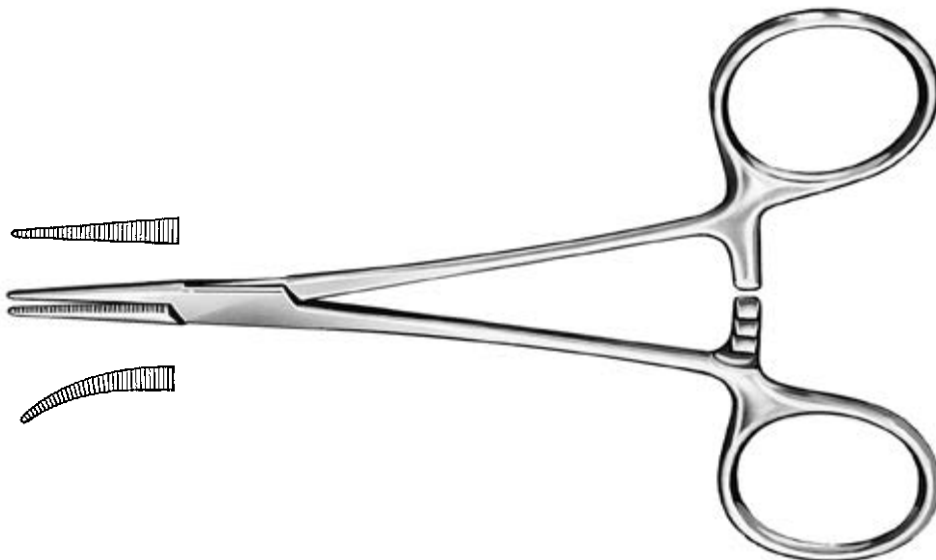

2275-12
HALSTED-MOSQUITO

gebogen
curved
courbe
curvo
12,5 cm



2285-15
GASS
1,5 mm



2286-10
KELLY
1,0 mm Ø

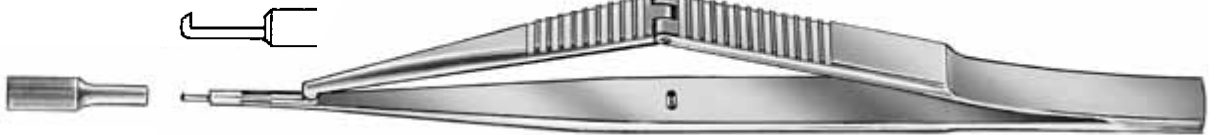

2287-20
WALSER
2,0 mm



2288-10
HOLTH
1,0 mm



2288-15
HOLTH
1,5 mm



STANZEN
PUNCHES



EMPORTE-PIÈCES
PUNZONES

2293-30
KERRISON
3 mm

2294-40
KERRISON
4 mm

2296-30
CITELLI
3 mm

2298-20
BEYER
2 mm



TREPHINE
TREPHINES

TRÉPANS
TRÉPANOS

SCHWEIZER MODELL

- 2312-10** = 1,0 mm Ø
- 2312-12** = 1,2 mm Ø
- 2312-15** = 1,5 mm Ø
- 2312-18** = 1,8 mm Ø



2319-00

Handgriff
Handle
Manche
Mango



- 2328-50** = 5,0 mm Ø
- 2328-55** = 5,5 mm Ø
- 2328-60** = 6,0 mm Ø
- 2328-65** = 6,5 mm Ø
- 2328-70** = 7,0 mm Ø
- 2328-75** = 7,5 mm Ø
- 2328-80** = 8,0 mm Ø
- 2328-85** = 8,5 mm Ø
- 2328-90** = 9,0 mm Ø
- 2329-10** = 10,0 mm Ø
- 2329-11** = 11,0 mm Ø



CASTROVIEJO

2367-20
CASTROVIEJO-SCHACHAR

gebogen
curved
courbe
curvo



2369-15
CASTROVIEJO

15 mm

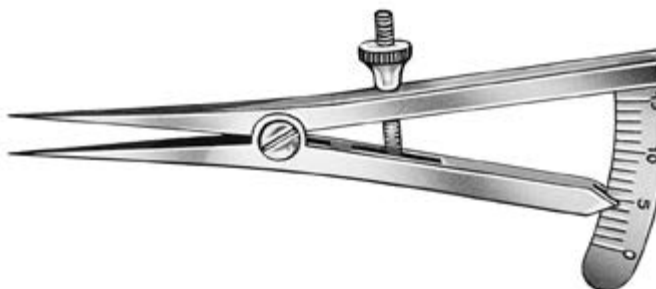

2370-20
CASTROVIEJO

20 mm



2375-00
MEYER-SCHWICKERATH



2380-15



- 2382-30** = 3,0 mm Ø
- 2382-35** = 3,5 mm Ø
- 2382-40** = 4,0 mm Ø
- 2382-50** = 5,0 mm Ø
- 2382-60** = 6,0 mm Ø
- 2382-70** = 7,0 mm Ø

HOFFER

Markierinstrumente
Optical center markers
Marqueurs optiques
Marcadores ópticos

Other sizes available on request



- 2383-30** = 3,0 mm Ø
- 2383-35** = 3,5 mm Ø
- 2383-40** = 4,0 mm Ø
- 2383-50** = 5,0 mm Ø

NEUMANN-SHEPARD

Markierinstrumente
Optical center markers
Marqueurs optiques
Marcadores ópticos

Other sizes available on request



- 2384-30** = 3,0 mm Ø
- 2384-35** = 3,5 mm Ø
- 2384-40** = 4,0 mm Ø
- 2384-50** = 5,0 mm Ø

BORES

Markierinstrumente
Optical center markers
Marqueurs optiques
Marcadores ópticos

Other sizes available on request



- 2385-06** = 6 lines
- 2385-08** = 8 lines
- 2385-12** = 12 lines
- 2385-16** = 16 lines

OSHER-NEUMANN

Markierinstrumente
Optical center markers
Marqueurs optiques
Marcadores ópticos



2392-00
SHEPARD-KREMER

Messblock
Caliper block
Règle graduée
Regula



FIXIERRINGE
FIXATION RINGS

ANNEAUX À FIXATION
ANILLOS DE FIJACION

2393-17
THORNTON



2394-13
NEUHANN
13 mm Ø



2395-13 = 13 mm Ø
2395-16 = 16 mm Ø
FINE-THORTON



FLIERINGA

Fixationsringe
Fixation rings
Anneaux rings
Anillos de fijación

2398-15 = 15 mm Ø
2398-16 = 16 mm Ø
2398-17 = 17 mm Ø
2398-18 = 18 mm Ø
2398-19 = 19 mm Ø
2398-20 = 20 mm Ø

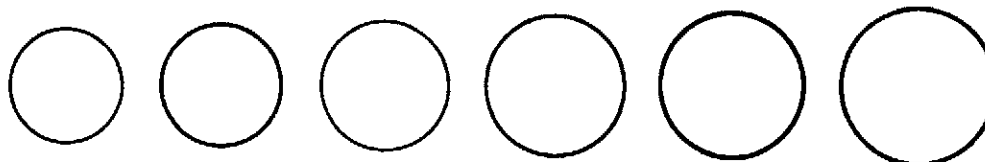

IRISPINZETTEN

IRIS FORCEPS



PINCES À IRIS

PINZAS PARA IRIS

CHIRURGISCHE PINZETTEN

TISSUE FORCEPS

PINCE CHIRURGICALE

PINZAS PARA TEJIDO

2400-05 = 0,5 mm
2400-07 = 0,7 mm
2400-10 = 1,0 mm
2400-12 = 1,2 mm



2401-07 = 0,7 mm
2401-10 = 1,0 mm



2403-07



ANATOMISCHE PINZETTEN

DRESSING FORCEPS

PINCE ANATOMIQUE

PINZAS PARA VENDAJES

2410-05 = 0,5 mm
2410-07 = 0,7 mm
2410-10 = 1,0 mm
2410-12 = 1,2 mm



2411-07



2413-07



2420-10
ADSON



2422-10
ADSON



PINZETTEN FÜR MICRO-CHIRURGIE
FORCEPS FOR MICRO-SURGERY



PINCES À MICRO-CHIRURGIE
PINZAS PARA MICRO-CIRUGIA

2425-00
ELZE



2430-02
DERMOT-PIERSE



vergrößert, enlarged, agrandi, agrandando



2432-00
REMKY



2434-12
BONNER MODELL

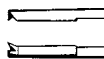

2436-12
BONNER MODELL

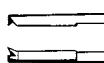

2438-12
BONNER MODELL

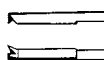

2440-30
McPHERSON

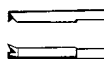

2441-30
McPHERSON



2442-50
McPHERSON

ohne Zähne
without teeth
sans dents
sin dientes



2443-50
McPHERSON

ohne Zähne
without teeth
sans dents
sin dientes



PINZETTEN FÜR MICRO-CHIRURGIE
FORCEPS FOR MICRO-SURGERY



PINCES À MICRO-CHIRURGIE
PINZAS PARA MICRO-CIRUGIA

2444-08
BONNER MODELL
 anatomisch, 8 mm gewinkelt
 without teeth, 8 mm angled
 sans dents, coudée 8 mm
 sin dientes, aguloso 8 mm



2445-12
BONNER MODELL
 0,12 mm
 mit Fadenplatte
 with tying platform
 avec plateforme
 con plata forma

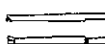

2446-12
BONNER MODELL
 0,12 mm
 ohne Fadenplatte
 without tying platform
 sans plateforme
 sin plata forma



2447-12
BONNER MODELL
 0,12 mm
 mit Fadenplatte
 with tying platform
 avec plateforme
 con plata forma



2448-00
BONNER MODELL
 ohne Zähne
 without teeth
 sans dents
 sin dientes



2448-12
BONNER MODELL
 (original)
 0,12 mm
 mit Fadenplatte
 with tying platform
 avec plateforme
 con plata forma

2448-20
BONNER MODELL
 0,20 mm
 mit Fadenplatte
 with tying platform
 avec plateforme
 con plata forma

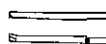

2449-12
BONNER MODELL
 0,12 mm
 ohne Fadenplatte
 without tying platform
 sans plateforme
 sin plata forma

2449-20
BONNER MODELL
 0,20 mm
 ohne Fadenplatte
 without tying platform
 sans plateforme
 sin plata forma

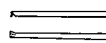

IRISPINZETTEN

IRIS FORCEPS



PINCES À IRIS

PINZAS PARA IRIS

2450-05 = 0,5 mm
2450-07 = 0,7 mm



vergrößert, enlarged, agrandi, agrandando



2451-05
HEIDELBERGER MODELL
0,5 mm



2457-05
HEIDELBERGER MODELL
0,5 mm



2451-07
0,7 mm



2452-07
0,7 mm

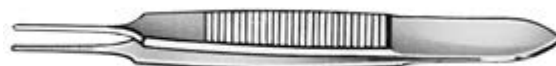

2453-07
0,7 mm



2454-00
BISHOP-HARMON
0,8 mm

2454-50
BISHOP-HARMON
0,5 mm



2454-05
BISHOP-HARMON
0,5 mm

2454-07
BISHOP-HARMON
0,7 mm



2456-00
LESTER



2458-00
MODELL HAMBURG



2465-00
HESS



2469-00
MASKET



vergrößert, enlarged, agrandi, agrandando

2470-12
KRAFF-UTRARA

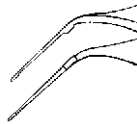

2471-05
UTRATA



vergrößert, enlarged, agrandi, agrandando

2471-10
UTRATA

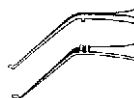

IOL-PINZETTEN

IOL-FORCEPS



PINCES POUR IOL

PINZAS PARA IOL

2480-00
BURATTO



2481-00
BURATTO



2483-06
LIVERNOIS



2485-00
BURATTO

Zum Falten von Linsen mit 5,5 und 6 mm Ø
Folding forceps for soft lenses 5,5 and 6 mm Ø
Pour plier des lentés de 5,5 et 6 mm Ø
Para doblar lentés con 5,5 y 6 mm Ø



2486-00
McDONALD II

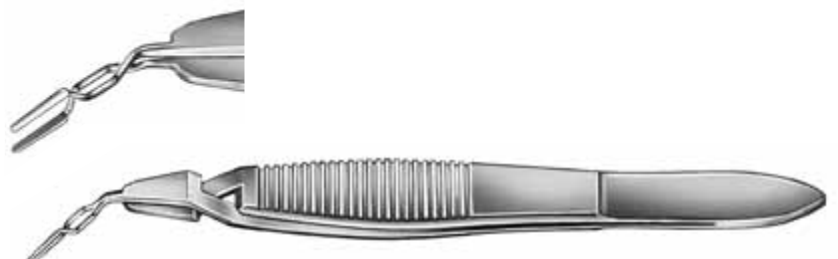

IOL-PINZETTEN
IOL-FORCEPS



PINCES POUR IOL
PINZAS PARA IOL

2490-00
CLAYMAN

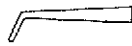

2491-00
DODEN



2493-80
SHEPARD



2494-00
BURATTO



2495-50
McPHERSON



2497-12 = 12,0 mm
2497-75 = 7,5 mm
2497-90 = 9,0 mm
KELMAN



KAPSELPINZETTEN
CAPSULE FORCEPS



PINCES CAPSULAIRES
PINZAS CAPSULARES

2502-00
HESS



2505-00
ARRUGA



2506-00
ARRUGA



2509-00
CASTROVIEJO



2510-00
SCHWEIZER MODELL

vergrößert
enlarged
agrandi
agrandando



2513-00
ARRUGA-NIZETIC



BINDEHAUTPINZETTE
CONJUNCTIVAL FORCEPS



PINZE À CONJUNCTIVA
PINZA PARA CONJUNCTIVA

2524-45
DRAEGER



FIXIERPINZETTEN
FIXATION FORCEPS

PINCES À FIXER
PINZAS DE FIJACIÓN

2532-00
GRAEFE

ohne Schloss
without catch
sans ressort
sin muelle



2533-00
GRAEFE

mit Schloss
with catch
avec ressort
con muelle



2537-00
JESS



2539-00
CASTROVIEJO



2540-00
CASTROVIEJO



vergrößert
enlarged
agrandi
agrandando

2541-00



2543-12
GREEN



2545-00
BARRAQUER



2546-00
TROUTMAN
Zügelnahtpinzette
Superior rectus forceps
Pince pour le muscle
droit supérieur
Pinza, recta superior



2548-12
KREMER
Hornhautfixierpinzette
Corneal fixation forceps
Pince à fixation
Pinzas para fijación



2549-00
REMKY
Zügelnahtpinzette
Superior rectus forceps
Pince pour le muscle
droit supérieur
Pinza, recta superior



**PINZETTEN FÜR SCHIELOPERATION
STRABISMUS FORCEPS**



**PINCES À STRABISME
PINZAS PARA ESTRABISMO**

2550-12

vergrößert
enlarged
agrandi
agrandando



2551-12



2553-00
Mc CULLOUGH



2554-00
Mc CULLOUGH

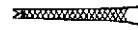

2555-15
BONACCOLTO



2556-23
BONACCOLTO



2558-10
ELSCHNIG



MUSKELPINZETTEN
MUSCLE FORCEPS



PINCES MUSCULAIRES
PINZAS MUSCULARES

2566-04
PRINCE

rechts
right
à droite
derecha



2567-04
PRINCE

links
left
à gauche
izquierda



2568-03
SATTLER

rechts
right
à droite
derecha



2569-03
SATTLER

links
left
à gauche
izquierda



2570-07
JAMESON

rechts
right
à droite
derecha



2571-07
JAMESON

links
left
à gauche
izquierda



2572-00
WORTH

rechts
right
à droite
derecha

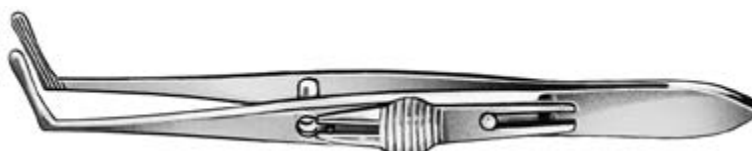

2573-00
WORTH

links
left
à gauche
izquierda

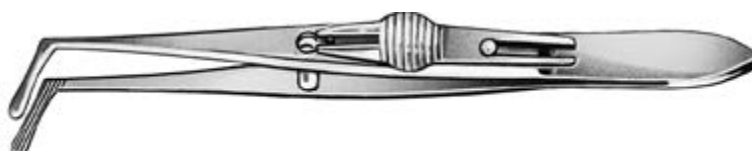

ENTROPIONSPINZETTEN
ENTROPIUM FORCEPS



PINCES À ENTROPION
PINZAS DE ENTROPIÓN

2575-00
BLASCOVIC



2576-00
BLASCOVIC



2578-20 20 mm
2578-27 27 mm
BERKE

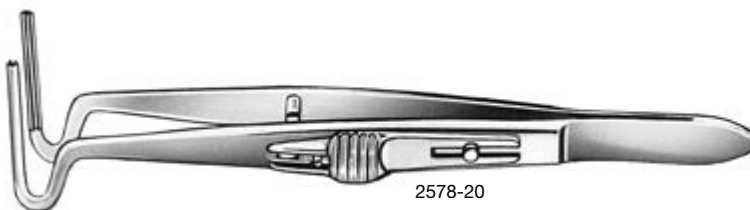

2579-10
BANGERTER
Muskelklemme
Muscle clamp
Pince pour les muscles
Pinzas de músculo



2582-00
WATZKE
Spreizpinzette
Forceps for spreading
Pince à écarter
Pinza para extender



2584-28
SNELLEN
links
left
à gauche
izquierda



2585-28
SNELLEN
rechts
right
à droite
derecha



CHALAZIONSPINZETTEN
CHALAZION FORCEPS



PINCES À CHALAZION
PINZAS DE CHALAZIÓN

2600-20 = 20 mm
2600-26 = 26 mm
2600-31 = 31 mm
2600-34 = 33 mm
DESMARRES



2602-08
AYER



2604-08
LAMBERT



2606-09
CAUER



2607-12
HUNT



2608-13
BAIRD



2609-11
LORDAN



CILIENPINZETTEN
CILIA FORCEPS



PINCE À ÉPILER LES CILS
PINZAS DEPILATORIAS

2621-00
HENRY



2622-00
GRADLE



2623-00
BARRAQUER
(normal)



2623-06
BARRAQUER



2626-15
SCHWEIZER MODELL



2628-00
BEER



2630-00
HEIDELBERGER MODELL



FREMDKÖRPERPINZETTEN
FOREIGN BODY FORCEPS

PINCES POUR CORPS ÉTRANGERS
PINZAS PARA CUERPOS EXTRAÑOS

2632-00
SPEEMANN



2635-00
SHAAF



PINZETTEN
FORCEPS



PINCES
PINZAS

2641-09
BARRAQUER

Vorderkammerpinzette
Secondary membrane forceps
Pincés pour la chambre antérieure
Pinzas para la Cámara anterior



2645-00

Pinzette für Sklera-Stopfen
Forceps for scleral plugs
Pincés pour obturateur scléral
Pinzas para tapón escleral



NAHTPINZETTEN

PINCES À SUTURES

SUTURE FORCEPS

PINZAS PARA SUTURAS

2665-12 = 0,12 mm
2665-35 = 0,35 mm
2665-60 = 0,60 mm
2665-90 = 0,90 mm

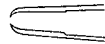

CASTROVIEJO

2667-12 = 0,12 mm
2667-35 = 0,35 mm
2667-60 = 0,60 mm

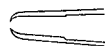

CASTROVIEJO

2666-50 = 0,50 mm



CASTROVIEJO

2669-45 = 0,45 mm
2669-60 = 0,60 mm

ohne Zähne
without teeth
sans dents
sin dientes



CASTROVIEJO

2664-75

ohne Zähne
without teeth
sans dents
sin dientes



2668-45
MODELL TUEBINGEN

ohne Zähne
without teeth
sans dents
sin dientes



NAHTPINZETTEN
SUTURE FORCEPS



PINCES À SUTURES
PINZAS PARA SUTURAS

2670-00
MODELL TUEBINGEN

ohne Zähne
without teeth
sans dents
sin dientes

vergrößert
enlarged
agrandi
agrandando



2671-10
BECHERT-McPHERSON



2673-00
PAUFIQUE

normal
normal
normal
normal

2673-35
PAUFIQUE

sehr fein
very delicate
très fin
muy fina

2676-40
PAUFIQUE

ohne Zähne
without teeth
sans dents
sin dientes



2674-00
ST. MARTIN



2675-00
MOORFIELD



2680-25 = 0,25 mm

2680-40 = 0,40 mm

COLIBRI

ohne Fadenplatte
without tying platform
sans plateforme
sin plataforma



2681-25 = 0,25 mm

2681-40 = 0,40 mm

COLIBRI

mit Fadenplatte
with tying platform
avec plateforme
con plataforma



NAHTPINZETTEN
SUTURE FORCEPS



PINCES À SUTURE
PINZAS PARA SUTURAS

2682-12 = 0,12 mm
2682-25 = 0,25 mm
2682-40 = 0,40 mm

COLIBRI-TROUTMAN

ohne Fadenplatte
without tying platform
sans plateforme
sin plata forma



2683-12 = 0,12 mm
2683-25 = 0,25 mm
2683-40 = 0,40 mm

COLIBRI-TROUTMAN

mit Fadenplatte
with tying platform
avec plateforme
con plata forma



2684-12
COLIBRI

kurze Zähne, mit Fadenplatte
short teeth, with tying platform
dentes courtes, avec plateforme
dientes cortos, con plata forma



2686-12 = 0,12 mm
2686-25 = 0,25 mm
2686-40 = 0,40 mm

COLIBRI-TROUTMAN

ohne Fadenplatte
without tying platform
sans plateforme
sin plata forma



2687-12 = 0,12 mm
2687-25 = 0,25 mm
2687-40 = 0,40 mm

COLIBRI-TROUTMAN

mit Fadenplatte
with tying platform
avec plateforme
con plata forma



2685-12
ZUERCHER MODELL

1 x 2 Zähne, sehr fein
1 x 2 teeth, extremely delicate
1 x 2 dents, extra fin
1 x 2 dientes, delicadísima

2685-25
ZUERCHER MODELL

1 x 2 Zähne, normale Größe
1 x 2 teeth, regular size
1 x 2 dents, taille normal
1 x 2 dientes, tamaño normal

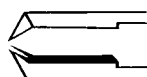

2685-26
ZUERCHER MODELL

1 x 2 Zähne, normale Größe, gewinkelt
1 x 2 teeth, regular size, angled
1 x 2 dents, taille normal, angulaire
1 x 2 dientes, tamaño normal, angulado

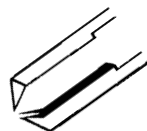

NAHTPINZETTEN
SUTURE FORCEPS



PINCES À SUTURE
PINZAS PARA SUTURAS

2688-00
BARRAQUER

Fadenlöspinzette, ohne Zähne
Suture removal forceps, without teeth
Pincés tire-fils, sans dents
Pinzas para quitar suturas, sin dientes



2690-00



2691-00



ENGLISCHES MODELL

mit Fadenplatte, ohne Zähne
with tying platform, without teeth
avec plateforme, sans dents
con plataforma, sin dientes

2693-25



2694-25



2695-25



ENGLISCHES MODELL

mit Fadenplatte, mit Zähnen 0,25 mm
with tying platform, with teeth 0.25 mm
avec plateforme, avec dents 0,25 mm
con plataforma, con dientes 0,25 mm

2696-25



ENGLISCHES MODELL

ohne Fadenplatte, mit Zähnen 0,25 mm
without tying platform, with teeth 0.25 mm
sans plateforme, avec dents 0,25 mm
sin plataforma, con dientes 0,25 mm

NADELHALTER
NEEDLE HOLDERS



PORTE-AIGUILLES
PORTA-AGUJAS

2700-10
BARRAQUER

mit Schloss
with catch
avec ressort
con muelle

2702-10
BARRAQUER
(Original)

ohne Schloss
without catch
sans ressort
sin muelle

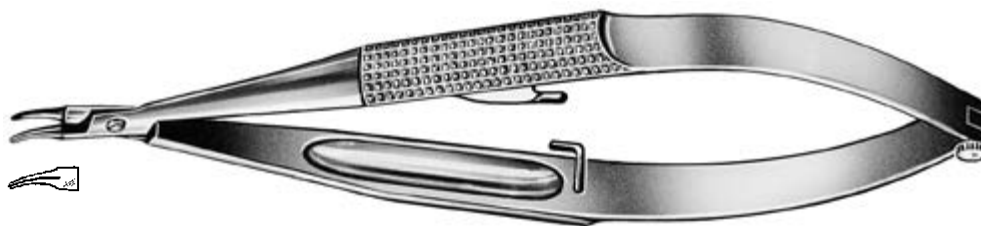

2704-13
KALT

gerade
straight
droit
recto

2705-13
KALT

gebogen
curved
courbe
curvo



2712-13
ARRUGA

gerade, mit Schloss
straight, with catch
droit, avec ressort
recto, con muelle

2712-99
ARRUGA

gerade, ohne Schloss
straight, without catch
droit, sans ressort
recto, sin muelle

2713-13
ARRUGA

gebogen, mit Schloss
curved, with catch
courbe, avec ressort
curvo, con muelle



2716-16
CASTROVIEJO-KALT



2720-00
STEVENS



2732-07
CASTROVIEJO

extra schlank
delicate jaw
extra-fine
extra-fina



2732-12
CASTROVIEJO

normal



2733-07
CASTROVIEJO

extra schlank
delicate jaw
extra-fine
extra-fina



2733-12
CASTROVIEJO

normal



2734-07
CASTROVIEJO

extra schlank
delicate jaw
extra-fine
extra-fina

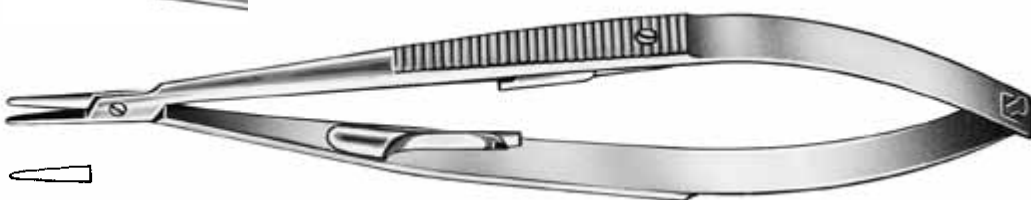

2734-12
CASTROVIEJO

normal



2735-07
CASTROVIEJO

extra schlank
delicate jaw
extra-fine
extra-fina

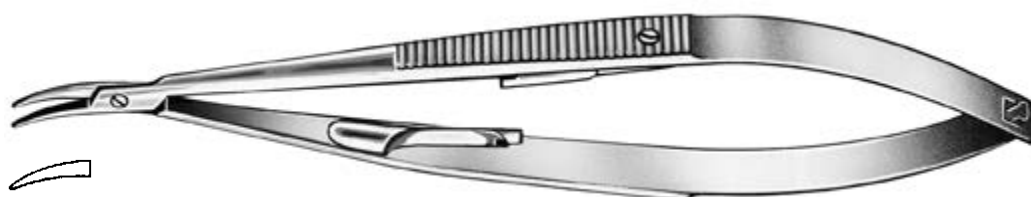

2735-12
CASTROVIEJO

normal



NADELHALTER
NEEDLE HOLDERS



PORTE-AIGUILLES
PORTA-AGUJAS

2752-10
BARRAQUER

gerade
straight
droit
recto

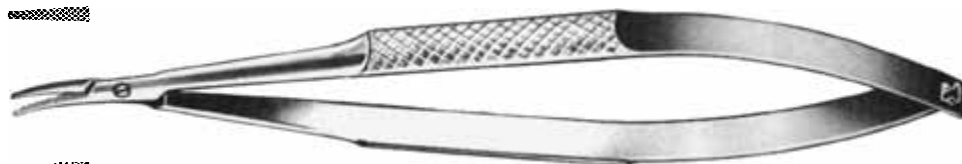

2753-10
BARRAQUER

gebogen
curved
courbe
curvo



2754-10
BARRAQUER

gerade
straight
droit
recto



2755-10
BARRAQUER

gebogen
curved
courbe
curvo



2757-10
BARRAQUER

gebogen, Maul 1,0 mm
curved, jaw 1,0 mm
courbe, mors 1,0 mm
curvo, boca 1,0 mm



2757-75
BARRAQUER

gebogen, Maul 0,75 mm
curved, jaw 0,75 mm
courbe, mors 0,75 mm
curvo, boca 0,75 mm



2759-10
BARRAQUER

gebogen, Maul 1,0 mm
curved, jaw 1,0 mm
courbe, mors 1,0 mm
curvo, boca 1,0 mm



2759-75
BARRAQUER

gebogen, Maul 0,75 mm
curved, jaw 0,75 mm
courbe, mors 0,75 mm
curvo, boca 0,75 mm



2762-10
BARRAQUER

gerade
straight
droit
recto

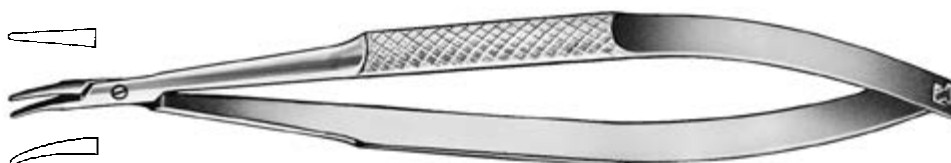

2763-10
BARRAQUER

gebogen
curved
courbe
curvo



NADELHALTER
NEEDLE HOLDERS



PORTE-AIGUILLES
PORTA-AGUJAS

2765-10
BARRAQUER

gebogen
curved
courbe
curvo



2766-50
BARRAQUER

gerade
straight
droit
recto



2767-50
BARRAQUER

gebogen
curved
courbe
curvo



2768-50
BARRAQUER

gerade
straight
droit
recto



2769-50
BARRAQUER

gebogen
curved
courbe
curvo

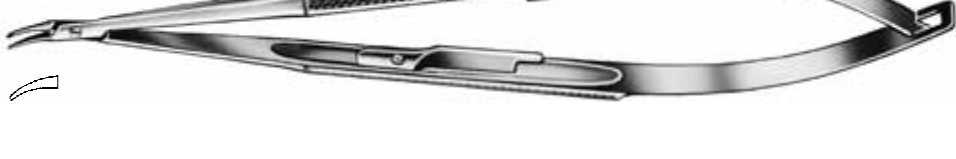

2773-06



2775-50
BARRAQUER

gebogen, Maul 0,50 mm
curved, jaw 0,50 mm
courbe, mors 0,50 mm
curvo, boca 0,50 mm

2775-75
BARRAQUER

gebogen, Maul 0,75 mm
curved, jaw 0,75 mm
courbe, mors 0,75 mm
curvo, boca 0,75 mm



2777-75
BARRAQUER

gebogen, Maul 0,75 mm
curved, jaw 0,75 mm
courbe, mors 0,75 mm
curvo, boca 0,75 mm



2783-05

stark gebogen
strong curved
très courbe
muy curvo



2786-50

BARRAQUER

gerade, Maul 0,50 mm
straight, jaw 0,50 mm
droit, mors 0,50 mm
recto, boca 0,50 mm



2787-50

BARRAQUER

gebogen, Maul 0,50 mm
curved, jaw 0,50 mm
courbe, mors 0,50 mm
curvo, boca 0,50 mm

2792-07

CASTROVIEJO



2793-07

CASTROVIEJO



2794-07

CASTROVIEJO



2795-07

CASTROVIEJO





**2996-00
SCHIOETZ**

Spec. 5

gerade Skala, mit Konformitätsbescheinigung
straight scale, with certificate of conformity
échelle droit, avec certificat de conformité
escale recta, con certificado de conformidad

**2998-00
SCHIOETZ**

Spec. 5

schräge Skala, mit Konformitätsbescheinigung
oblique scale, with certificate of conformity
échelle oblique, avec certificat de conformité
escale oblicuo, con certificado de conformidad

**2999-00
SCHIOETZ**

Spec. 5

schräge Skala, mit Konformitätsbescheinigung,
rostsicherer Stahl, für Dampfsterilisation geeignet

oblique scale, with certificate of conformity,
stainless steel, autoclavable

échelle oblique, avec certificat de conformité,
acier inoxydable, pour stérilisation à vapeur

escale oblicuo, con certificado de conformidad,
acero inoxidable, esterizable en autoclave

**Nur für Export:
For export only:
Seulement pour exportation:
Solamente para exportación:**

**2991-00
SCHIOETZ**

Spec. 3

straight scale
échelle droit
escale recta

**2993-00
SCHIOETZ**

Spec. 3

oblique scale
échelle oblique
escale oblicuo

**2995-00
SCHIOETZ**

Spec. 5

straight scale
échelle droit
escale recta

**2997-00
SCHIOETZ**

Spec. 5

oblique scale
échelle oblique
escale oblicuo



M 1 : 2



3500-00
BARRAQUER
normal

3500-01
BARRAQUER
extra feines Maul
extremely fine jaws
mâchoires ultra fines
boca extramadamente fina



3504-06
CASTROVIEJO



3505-06
CASTROVIEJO



3506-07
für Mikro-Klingen
for micro-blades
pour micro-lames
para micro-hojas



3507-06
TROUTMAN



3509-07
Chuck handle





3510-00

10 St. Spezialklingen, rostfrei
10 ea. special blades, stainless
10 pcs. lames especiales, inoxydable
10 piezas hojas, inoxidable



3525-03
Modell 3



3525-7K
Modell 7K



Andere Modelle auf Wunsch erhältlich
Other models available
Autres modèles sur demande
Otros modelos, sobre demande

KANÜLEN
CANNULAS



CANULES
CANULAS

LUER-KONUS

LUER-LOCK

3600-30 30 gauge / 0,30 mm Ø
3600-40 27 gauge / 0,40 mm Ø



mit stumpfer Spitze
with blunt point
avec pointe mousse
con punta roma

3602-30 30 gauge / 0,30 mm Ø
3602-40 27 gauge / 0,40 mm Ø



mit stumpfer Spitze
with blunt point
avec pointe mousse
con punta roma

3603-30 30 gauge / 0,30 mm Ø
3603-40 27 gauge / 0,40 mm Ø



mit stumpfer Spitze
with blunt point
avec pointe mousse
con punta roma

3604-23 23 gauge / 0,65 mm Ø
3604-27 27 gauge / 0,40 mm Ø
3604-30 30 gauge / 0,30 mm Ø
RAININ



Luftkanüle, spatelförmige Spitze
Air injection cannula, spatulated tip
Canule air, pointe aplatie
Cánula para aire, punta spatula

3605-22 22 gauge / 0,70 mm Ø



Healon Injektionskanüle
Healon injection cannula
Canule pour injection d'healon
Cánula para inyección de healon

3606-26 26 gauge / 0,45 mm Ø
3606-27 27 gauge / 0,40 mm Ø
SAUTTER



Luftkanüle
Air injection cannula
Canule à air
Cánula para aire

3609-70 22 gauge / 0,70 mm Ø
ANEL



Tränenwegkanüle
Lacrimal cannula
Canule à voie lacrymal
Cánula para canal lacrimal

3610-70 22 gauge / 0,70 mm Ø
ANEL



Tränenwegkanüle
Lacrimal cannula
Canule à voie lacrymal
Cánula para canal lacrimal

3611-70 22 gauge / 0,70 mm Ø
ANEL



Tränenwegkanüle
Lacrimal cannula
Canule à voie lacrymal
Cánula para canal lacrimal

3612-21 21 gauge / 0,80 mm Ø
BRAUWEILER



3613-19 19 gauge / 1,00 mm Ø
BONNER MODELL



Spülkanüle, fein
Irrigating cannula, delicate
Canule irrigatoire, fine
Cánula para irrigación, delicada

3614-10 Olive 1,1 mm Ø



3615-10 Olive 1,1 mm Ø



3616-25
TROUTMAN



Alpha-Chymotrypsin Kanüle, Olive 1,2 mm Ø
Alpha-Chymotrypsin Cannula, Olive 1,2 mm Ø
Alpha-Chymotrypsin Canule, Olive 1,2 mm Ø
Alpha-Chymotrypsin Cánula, Olive 1,2 mm Ø

LUER-KONUS

LUER-LOCK

**3617-46
ATKINSON**



Retrobulbäre Kanüle, 40 x 0,6 mm Ø
Retrobulbar Needle, 40 mm x 23 gauge
Canule retrobulbaire, 40 x 0,6 mm Ø
Cánula retrobulbar, 40 x 0,60 mm Ø

**3623-19
RANDOLPH**



Kanüle zur Cyklodialyse
Cycloplegic cannula
Canule pour cycloplegic
Cánula para ciclodíalisis

**3630-30
SHEPARD**



Spülkanüle für radiale Keratotomie
Radial Keratotomy Irrigating Cannula
Canule irrigatoire pour la kératotomie radiale
Cánula para irrigación para queratotomía radial

**3631-00
CRANZ**



Augenbrause, Silber
Irrigating anterior chamber cannula, silver
Canule irrigatoire multitrous, argent
Cánula para irrigación de cámara anterior, plata

3632-23



Tränenwegkanüle, V2A-Stahl
Lacrimal cannula, stainless steel
Canule à voies lacrymales, inox
Cánula lacrimal, inox

3633-23



Tränenwegkanüle, V2A-Stahl
Lacrimal cannula, stainless steel
Canule à voies lacrymales, inox
Cánula lacrimal, inox

3634-23



Tränenwegkanüle, V2A-Stahl
Lacrimal cannula, stainless steel
Canule à voies lacrymales, inox
Cánula lacrimal, inox

3635-23



Tränenwegkanüle, V2A-Stahl
Lacrimal cannula, stainless steel
Canule à voies lacrymales, inox
Cánula lacrimal, inox

KANÜLEN
CANNULAS



CANULES
CANULAS

LUER-KONUS

LUER-LOCK

3640-23 23 gauge
3640-26 26 gauge
3640-30 30 gauge
McINTYRE



Vorderkammer-Spülkanüle
Anterior chamber irrigating cannula
Canule irrigatoire pour la chambre antérieure
Cánula para irrigación para la cámara anterior

3641-23 23 gauge
3641-26 26 gauge
3641-30 30 gauge
McINTYRE



Vorderkammer-Spülkanüle
Anterior chamber irrigating cannula
Canule irrigatoire pour la chambre antérieure
Cánula para irrigación para la cámara anterior

3648-23
McINTYRE



Tränenwegkanüle mit 2 seitlichen Öffnungen
Lacrimal cannula with 2 side openings
Canule à voies lacrymales avec 2 orifices latéral
Cánula lacrimal con 2 orificios lateral

3649-23
McINTYRE



Tränenwegkanüle mit 2 seitlichen Öffnungen
Lacrimal cannula with 2 side opening
Canule à voies lacrymales avec 2 orifices latéral
Cánula lacrimal con 2 orificios lateral

3650-20 20 gauge
3650-23 23 gauge
WEST



Spülkanüle, seitliche Öffnung
Irrigating cannula, side opening
Canule irrigatoire, orifice latéral
Cánula para irrigación, orificio lateral

3652-46 40 x 0,6 mm Ø
3652-48 40 x 0,8 mm Ø
3652-66 60 x 0,6 mm Ø
3652-68 60 x 0,8 mm Ø
BANGERTER



Sondenkanüle
Probe cannula
Canule-sonde
Cánula tipo sonda

3654-23 13 mm
3655-23 21 mm
SIMCOE



Kortex-Extractor
Cortex extractor
Extracteur de cortex
Extractor para corteza

KANÜLEN
CANNULAS



CANULES
CANULAS

LUER-KONUS

LUER-LOCK

- 3658-25** 2,5 mm lang
- 3658-40** 4,0 mm lang
- 3658-50** 5,0 mm lang
- 3658-60** 6,0 mm lang



Infusionshalterungen
Infusion cannulas
Canules pour perfusion
Cánulas para infusión

3660-23
HESLIN

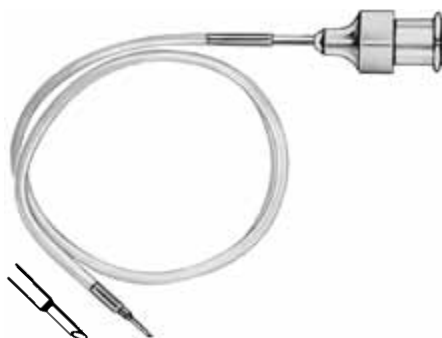

Infusionskanüle
Infusion cannula
Canule de perfusion
Cánula para infusión

3662-23
SIMCOE
Original-Modell
Original model
Modèle original
Modelo original

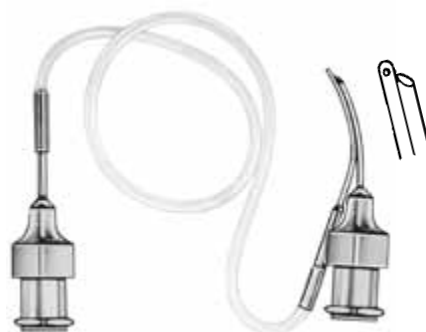

Saug- und Spülkanüle
Irrigation-aspirating cannula
Canule pour aspiration et irrigation
Cánula para aspiración y irrigación

3663-23
mit vertauschten Anschlüssen
with tubes reversed
avec branchements inversés
con conexiones permutadas

3664-01
SIMCOE
Saug- und Spülkanüle für
12 h-Position, rechts
Irrigating-Aspirating Cannula
for 12 o'clock aspiration, right

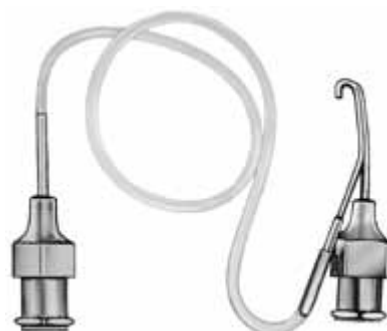

3664-02
SIMCOE
Saug- und Spülkanüle für
12 h-Position, links
Irrigating-Aspirating Cannula
for 12 o'clock aspiration, left

LUER-KONUS

LUER-LOCK

3665-23 23 gauge
3665-30 30 gauge
KNOLLE



Vorderkammer-Spülkanüle
Anterior chamber irrigating cannula
Canule irrigatoire pour la chambre antérieure
Cánula para irrigación para la cámara anterior

3670-23
KNOLLE-PEARCE



Linsenschlinge mit Spülung
Irrigating vectis
Anse à lentilles avec irrigation
Asa para lentes con irrigación

3671-20
SHEETS



Linsenschlinge mit Spülung
Irrigating vectis
Anse à lentilles avec irrigation
Asa para lentes con irrigación

3675-23
GRANDON

links
left
à gauche
izquierda

3676-23
GRANDON

rechts
right
à droite
derecha



Saug- und Spülkanüle
Irrigation-aspirating cannula
Canule pour aspiration et irrigation
Cánula para aspiración y irrigación

3680-22
KRATZ

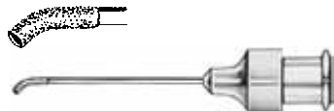

Kapselpolierer, diamantbeschichtet
Capsule polisher, diamond dusted
Polissoir capsulaire, diamanté
Pulidor para cápsula, con diamante

3681-22
RUBMAN-KATZIN



Kapselpolierer, diamantbeschichtet
Posterior capsule polisher, diamond dusted
Polissoir capsulaire, diamanté
Pulidor para cápsula, con diamante

3683-23 23 gauge
3683-25 25 gauge
JENSEN



Kapselpolierer, diamantbeschichtet
Posterior capsule polisher, diamond dusted
Polissoir capsulaire, diamanté
Pulidor para cápsula, con diamante

3684-23 23 gauge
KNOLLE



Kapselpolierer, diamantbeschichtet
Posterior capsule polisher, diamond dusted
Polissoir capsulaire, diamanté
Pulidor para cápsula, con diamante

3685-23 23 gauge
KNOLLE



Kapselpolierer, aufgerauht
Posterior capsule polisher, sandblasted
Polissoir capsulaire, gratteuse
Pulidor para cápsula, rugoso



BISHOP-HARMON

3686-19 Kanüle 19 gauge / 1,0 mm Ø
Cannula 19 gauge / 1,0 mm Ø
Canule 19 gauge / 1,0 mm Ø
Cánula 19 gauge / 1,0 mm Ø

3686-50 Silikon Ball
Silicone bulb
Ballon de silicone
Pera de silicona

3686-60 Zwischenstück
Adaptor
Adapteur
Adaptador

3686-99 Komplett
Complete
Complète
Completo



3689-00 Handgriff
Infusion handle
KANSAS Manche pour perfusion
Mango para infusión



3700-00

160 x 85 mm
rostsicher
stainless steel
inox



3710-00

160 x 85 mm
Silikoneinsatz für 10 Heftinstrumente, passend in Etui 3700-00.
Silicone tray for 10 cutting instruments, fitting into box 3700-00.
Boîte de silicone avec chevalet pour 10 instruments tranchants, s'adaptant dans l'etui 3700-00.
Bandeja de silicona para 10 instrumentos cortantes, ajustandose en el estuche 3700-00.

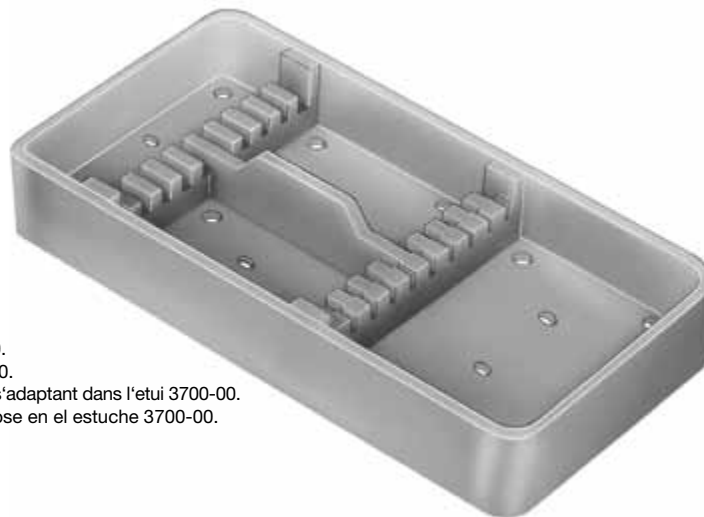

3715-12

Kanülenbänkchen für 12 Kanülen
Silicone tray for 12 cannulas
Boîte de silicone pour 12 canules
Bandeja de silicona para 12 canulas



3720-00

Silicone
300 x 600 mm
Noppenmatte
Burl plate
Plateau à nopes
Bandeja con puas

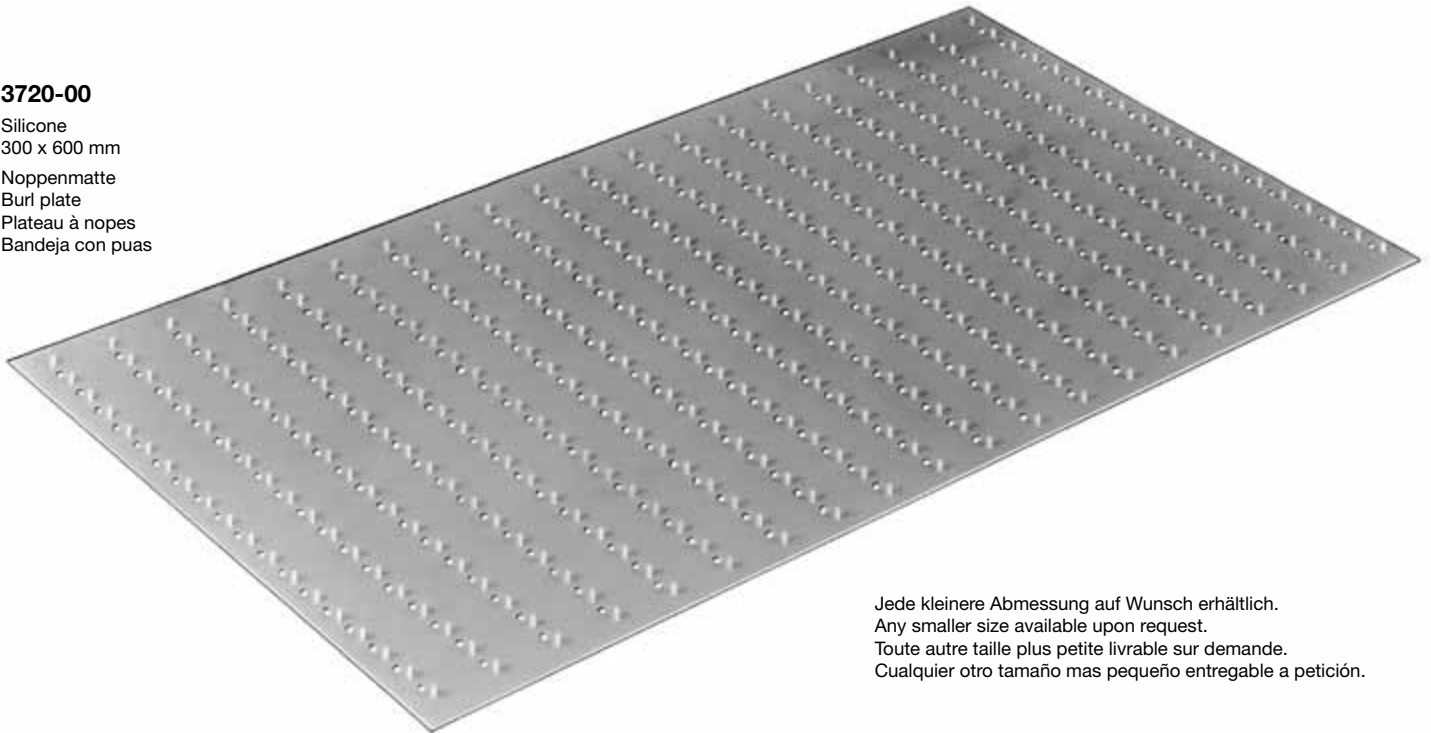

Jede kleinere Abmessung auf Wunsch erhältlich.
Any smaller size available upon request.
Toute autre taille plus petite livrable sur demande.
Cualquier otro tamaño mas pequeño entregable a petición.

3720-01

Silicone
160 x 85 mm
Passend in Etui 3700-00
Fitting into box 3700-00
Pour boîte 3700-00
Para caja 3700-00

3725-46

460 x 30 mm
Silikon-Noppenstreifen
Silicone bar
Garniture de silicone pour déposer les instruments
Franja de silicona

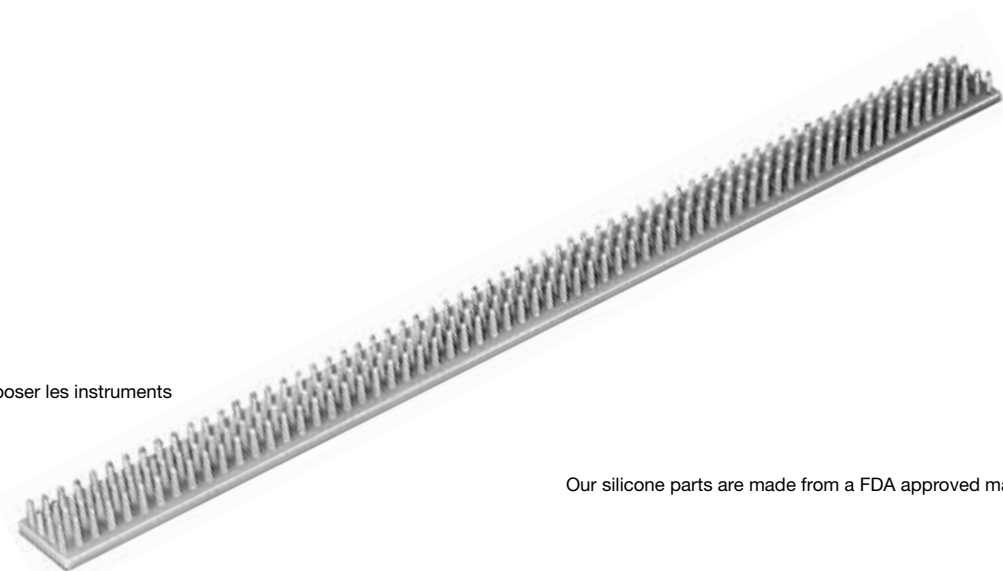

Our silicone parts are made from a FDA approved material.

Sterilisierbehälter aus Edelstahl mit Noppenplatten
Stainless steel sterilization cases with silicone burl plates
Boîtes de stérilisation inox avec support silicone
Cajas para esterilizar inox con bandejas de silicona



3741-50 200 x 140 x 50 mm
3744-50 280 x 195 x 50 mm
3745-50 265 x 255 x 50 mm
3746-50 370 x 190 x 50 mm
3747-50 380 x 260 x 50 mm

Einlagig
1 layer
1 étage
1 capa

3741-65 200 x 140 x 65 mm
3744-65 280 x 195 x 65 mm
3745-65 265 x 255 x 65 mm
3746-65 370 x 190 x 65 mm
3747-65 380 x 260 x 65 mm

Zweilagig
2 layers
2 étages
2 capas

BEHÄLTER
BOWLES



BOITES
CUBETAS

3760-06 Ø 61 x 30 mm
3760-11 Ø 116 x 35 mm

Nirosta
Stainless steel
Acier inoxydable
Acero inoxidable



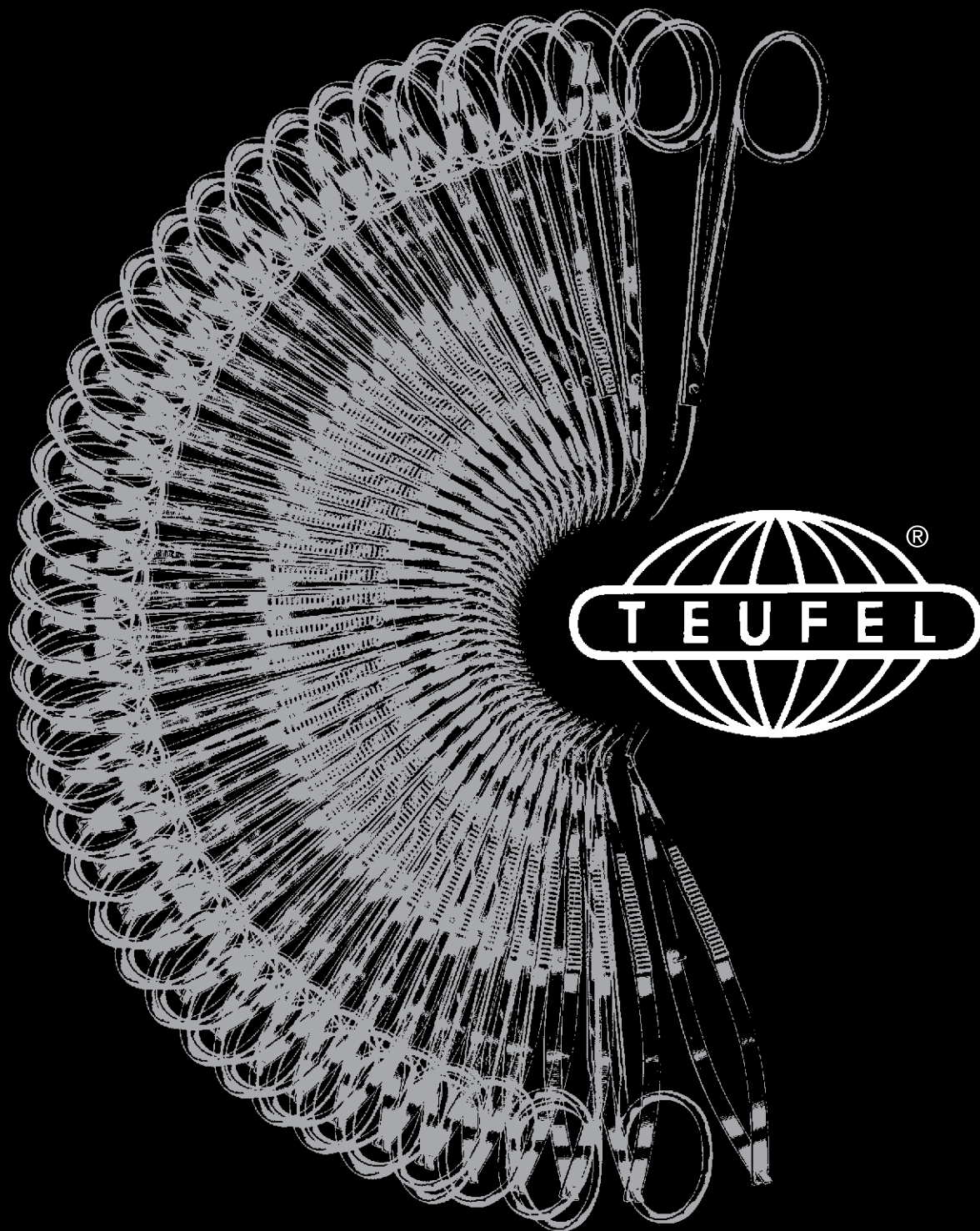

**AUGEN-
SCHEREN**

**OPHTHALMIC
SCISSORS**

**CISEAUX
OCULAIRES**

**TIJERAS
OCULARES**

IRIDEKTOMIESCHEREN

IRIS SCISSORS



CISEAUX À IRIDECTOMIE

TIJERAS PARA IRIDECTOMIA



4000-41 4000-42 4000-43

10,0 cm

gerade, straight, droit, recto



4001-41 4001-42 4001-43

10,0 cm

gebogen, curved, courbe, curvo



4006-41 4006-42 4006-43

11,0 cm

gerade, straight, droit, recto



4007-41 4007-42 4007-43

11,0 cm

gebogen, curved, courbe, curvo



4010-41 4010-42 4010-43

NOYES

11,5 cm

gerade, straight, droit, recto



4011-41 4011-42 4011-43

NOYES

11,5 cm

gebogen, curved, courbe, curvo



IRIDEKTOMIESCHEREN

IRIS SCISSORS



CISEAUX À IRIDECTOMIE
TIJERAS PARA IRIDECTOMIA

4021-08 

4022-08 

4023-08 

4024-08
WECKER 



8 mm Klingenlänge
8 mm length of cutting blades
8 mm longueur des lames
8 mm largo de las hojas

4021-12 

4022-12 

4023-12 

4024-12
WECKER 



12 mm Klingenlänge
12 mm length of cutting blades
12 mm longueur des lames
12 mm largo de las hojas



4030-07 4033-07
BARRAQUER

7 mm (normal)



7 mm Klingenlänge
7 mm length of cutting blades
7 mm longueur des lames
7 mm largo de las hojas



4030-10 4033-10
BARRAQUER

10 mm



10 mm Klingenlänge
10 mm length of cutting blades
10 mm longueur des lames
10 mm largo de las hojas

VANNAS SCHEREN
VANNAS SCISSORS



CISEAUX VANNAS
TIJERAS VANNAS

Normale Größe – Regular size – Taille normal – Tamaño normal

4040-41
VANNAS

gerade
straight
droit
recto



4041-41
VANNAS

gebogen
curved
courbe
curvo



4042-41
VANNAS

leicht aufgewinkelt
slightly angled on flat
légèrement angulaire
ligeramente angulado

4043-41
VANNAS

stark aufgewinkelt
strong angled on flat
très angulaire
muy angulado



4044-41
VANNAS

kniegebogen
angled to side
coudé
angulado



Extra klein – Extremely delicate – Extra fine – Delicadísima

4046-41
VANNAS

gerade
straight
droit
recto



4047-41
VANNAS

gebogen
curved
courbe
curvo



4048-41
VANNAS

kniegebogen
angled to side
coudé
angulado



4049-41
VANNAS

leicht aufgewinkelt
slightly angled on flat
légèrement angulaire
ligeramente angulado



VANNAS-ARTIGE SCHEREN

VANNAS TYPE SCISSORS



CISEAUX VANNAS

TIJERAS TIPO VANNAS

4050-41

MODELL TUEBINGEN

gerade
straight
droit
recto



4051-41

MODELL TUEBINGEN

gebogen
curved
courbe
curvo

4053-41

MODELL TUEBINGEN

stark gebogen
strong curved
très courbe
muy curvo



4052-41

Siehe Seite 40.05

4054-41

See page 40.05

4057-41

Voir page 40.05
Véase página 40.05

4060-61

CASTROVIEJO-VANNAS

gerade
straight
droit
recto

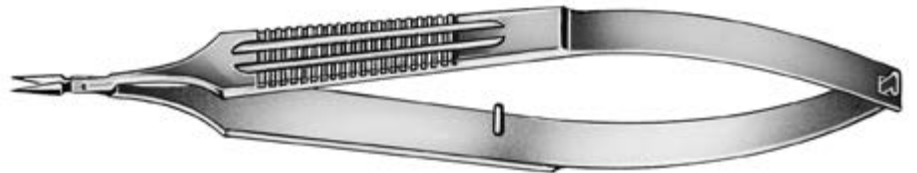

4061-61

CASTROVIEJO-VANNAS

gebogen
curved
courbe
curvo

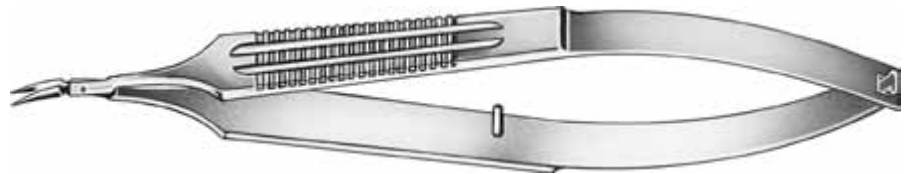

4065-43

gebogen, leicht stumpf
curved, slightly blunt
courbe, mousse
curvo, romo



4067-43

gebogen, leicht stumpf
curved, slightly blunt
courbe, mousse
curvo, romo



4070-41

Trabekular-Schere, gerade
Trabecular scissors, straight
Ciseaux à trabéculaires, droit
Tijeras trabeculares, rectas



4071-41

Trabekular-Schere, gebogen
Trabecular scissors, curved
Ciseaux à trabéculaires, courbe
Tijeras trabeculares, curvas



KAPSELSCHEREN
CAPSULE SCISSORS



CISEAUX CAPSULAIRES
TIJERAS PARA CAPSULA

4052-41
GILL



4054-41 **4056-41**
ONG
12 mm 9 mm

aufgewinkelt
angled on flat
angulaire
angulado



4057-41
ONG

gebogen
curved
courbe
curvo



4075-41
URIBE-STERN



4077-41
HOFFER-STERN



4079-41
UTHOFF



4081-41
GILLS



4083-41
GILLS-VANNAS

4200-71

gerade
straight
droit
recto



4201-71

gebogen
curved
courbe
curvo



4205-43

stark gebogen
strong curved
très courbe
muy curvo



4207-73

stark gebogen
strong curved
très courbe
muy curvo



4209-71
KOCH



4210-43

aufgewinkelt
angled on flat
angulaire
angulado



4212-73

aufgewinkelt
angled on flat
angulaire
angulado

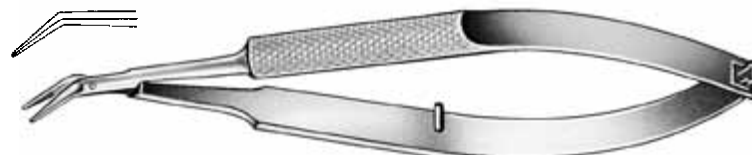

4214-83
BARRAQUER MINIATUR

aufgewinkelt, rechts
angled on flat, right
angulaire, à droite
angulado, derecha



4218-83
BARRAQUER MINIATUR

aufgewinkelt, links
angled on flat, left
angulaire, à gauche
angulado, izquierda

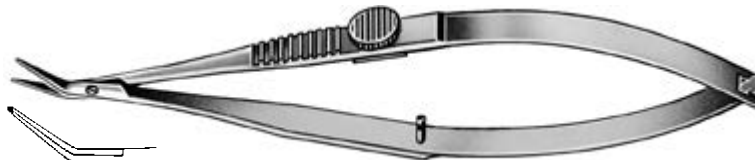

4224-43

kniegebogen
angled to side
coudé
angulado



4226-73

kniegebogen
angled to side
coudé
angulado

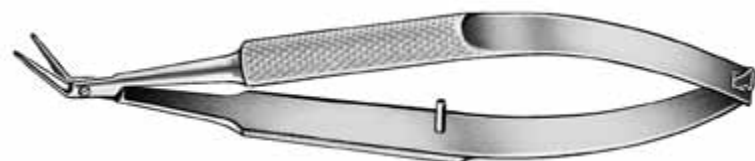

4231-43
WESTCOTT
(Mc PHERSON)

gebogen
curved
courbe
curvo



4251-43
Mc GUIRE

rechts
right
à droite
derecha



4253-53
Mc GUIRE

links
left
à gauche
izquierda



HORNHAUTSCHEREN
CORNEAL SCISSORS



CISEAUX POUR LA CORNÉE
TIJERAS PARA LA CORNEA

MATTIERT
NON-GLARE FINISH

SURFACE MATE
SUPERFICIE MATE

4301-47
TROUTMAN
Original-Modell
links
left
à gauche
izquierda

4309-47
stark gebogen
strong curved
très courbe
muy curvo



4301-56
TROUTMAN
Original-Modell
rechts
right
à droite
derecha

4309-56
stark gebogen
strong curved
très courbe
muy curvo



4303-86
TROUTMAN
rechts
right
à droite
derecha



4303-87
TROUTMAN
links
left
à gauche
izquierda



4305-76
rechts
right
à droite
derecha



4305-77
links
left
à gauche
izquierda



4307-47
TROUTMAN
links
left
à gauche
izquierda

4307-57
mit vertauschten Klängen
reversed blades
avec lames inversés
con hojas permutadas

extra schlank
extremely delicate
extra fine
delicadísima



4307-56
TROUTMAN
rechts
right
à droite
derecha

4307-46
mit vertauschten Klängen
reversed blades
avec lames inversés
con hojas permutadas



HORNHAUTSCHEREN
CORNEAL SCISSORS



CISEAUX POUR LA CORNÉE
TIJERAS PARA LA CORNEA

4321-46

KATZIN

rechts
right
à droite
derecha



4321-57

KATZIN

links
left
à gauche
izquierda



4323-86

KATZIN

rechts
right
à droite
derecha



4323-87

KATZIN

links
left
à gauche
izquierda



4331-46

KATZIN

rechts
right
à droite
derecha



4331-57

KATZIN

links
left
à gauche
izquierda



HORNHAUTSCHEREN
CORNEAL SCISSORS



CISEAUX POUR LA CORNÉE
TIJERAS PARA LA CORNEA

4351-47
CASTROVIEJO

links
left
à gauche
izquierda



4351-56
CASTROVIEJO

rechts
right
à droite
derecha



4361-47
CASTROVIEJO MINIATUR

links
left
à gauche
izquierda



4361-56
CASTROVIEJO MINIATUR

rechts
right
à droite
derecha



4363-87
CASTROVIEJO MINIATUR

links
left
à gauche
izquierda



4363-86
CASTROVIEJO MINIATUR

rechts
right
à droite
derecha



HORNHAUTSCHEREN
CORNEAL SCISSORS



CISEAUX POUR LA CORNÉE
TIJERAS PARA LA CORNEA

4365-66
CASTROVIEJO MINIATUR

rechts
right
à droite
derecha

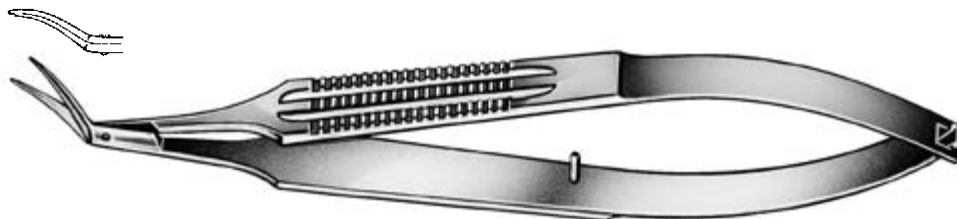

4365-67
CASTROVIEJO MINIATUR

links
left
à gauche
izquierda

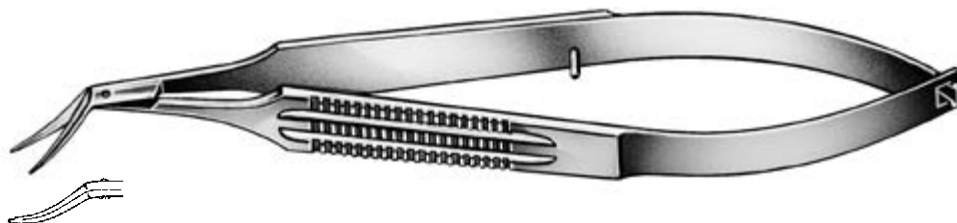

4367-86
CASTROVIEJO MINIATUR

rechts
right
à droite
derecha

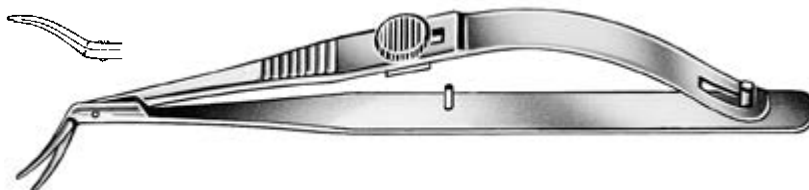

4367-87
CASTROVIEJO MINIATUR

links
left
à gauche
izquierda

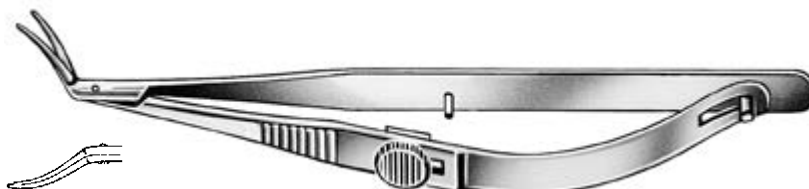

4371-47
CASTROVIEJO MICRO-MINIATUR

links
left
à gauche
izquierda



4371-56
CASTROVIEJO MICRO-MINIATUR

rechts
right
à droite
derecha

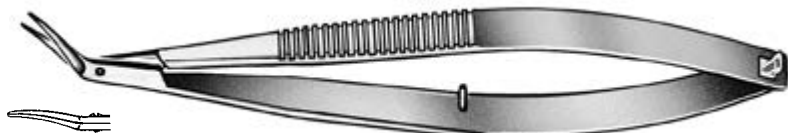

HORNHAUTSCHEREN
CORNEAL SCISSORS



CISEAUX POUR LA CORNÉE
TIJERAS PARA LA CORNEA



kniegebogen
angled to side
coudé
angulado



leicht gebogen
slightly curved
légèrement courbé
ligeramente curvo



stark gebogen
strong curved
très courbe
muy curvo



aufgewinkelt, rechts
angled on flat, right
angulaire, à droit
angulado, derecha



aufgewinkelt, links
angled on flat, left
angulaire, à gauche
angulado, izquierda

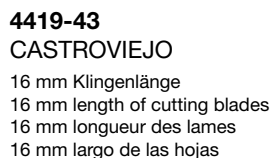
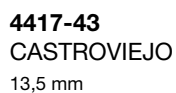
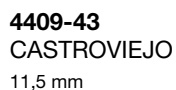
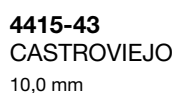
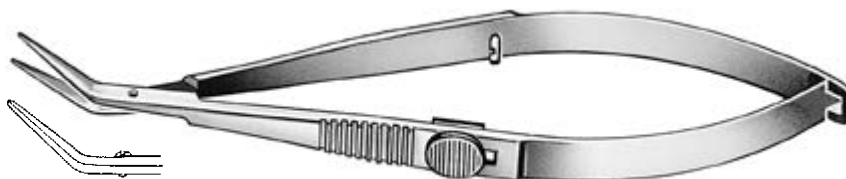

HORNHAUTSCHEREN
CORNEAL SCISSORS



CISEAUX POUR LA CORNÉE
TIJERAS PARA LA CORNEA



4420-43
CASTROVIEJO

kniegebogen
angled to side
coudé
angulado



4420-41 4420-42 4420-43 4420-44
CASTROVIEJO

Keratoplastikscheren, kniegebogen
Keratoplasty scissors, angled to side
Ciseaux pour kératoplastie, coudé
Tijeras para queratoplastia, angulado



4423-43
MACKENSEN

Keratoplastikschere
Keratoplasty scissors
Ciseaux pour kératoplastie
Tijeras para queratoplastia



VERSCHIEDENES
MISCELLANEOUS

DIVERS
DIVERSOS

4431-43
CASTROVIEJO

Synechia-Schere
Synechia scissors
Ciseaux à synéchie
Tijeras de sinequia

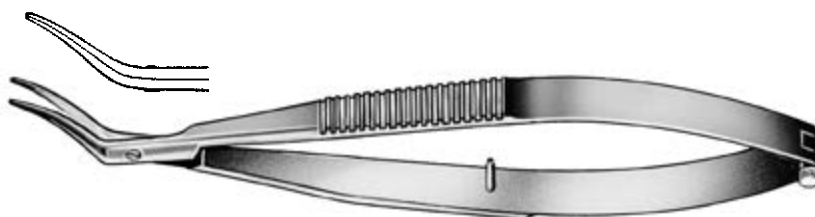

4432-43
90° kniegebogen
90° angled to side
90° coudé
90° angulado



SEHNENSCHEREN
TENOTOMY SCISSORS



CISEAUX À TÉNOTOMIE
TIJERAS PARA TENOTOMIA

4551-41
WESTCOTT

gebogen, spitz
curved, pointed
courbe, pointu
curvo, agudo



4550-43
WESTCOTT

gerade, stumpf/stumpf
straight, blunt tips
droit, mousse
recto, romo

4551-43
WESTCOTT

gebogen, stumpf/stumpf
curved, blunt tips
courbe, mousse
curvo, romo



4551-53
WESTCOTT

gebogen, stumpf/stumpf, links
curved, blunt tips, left
courbe, mousse, à gauche
curvo, romo, izquierda



4553-43
WESTCOTT

gebogen, stumpf/stumpf
curved, blunt tips
courbe, mousse
curvo, romo
130 mm



4555-61
WESTCOTT

gebogen, spitz
curved, pointed
courbe, pointu
curvo, agudo

4555-63
WESTCOTT

gebogen, stumpf/stumpf
curved, blunt tips
courbe, mousse
curvo, romo

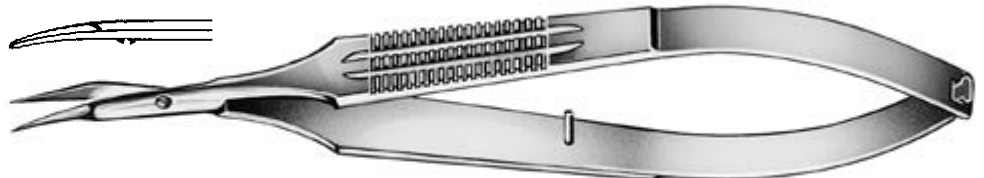

4557-43
WESTCOTT

Kleines Modell
Small blades
Modèle petite
Modelo pequeño



SEHNENSCHEREN
TENOTOMY SCISSORS



CISEAUX À TÉNOTOMIE
TIJERAS PARA TENOTOMIA

4600-03
STEVENS

10,5 cm
gerade, stumpf/stumpf
straight, blunt tips
droit, mousse
recto, romo

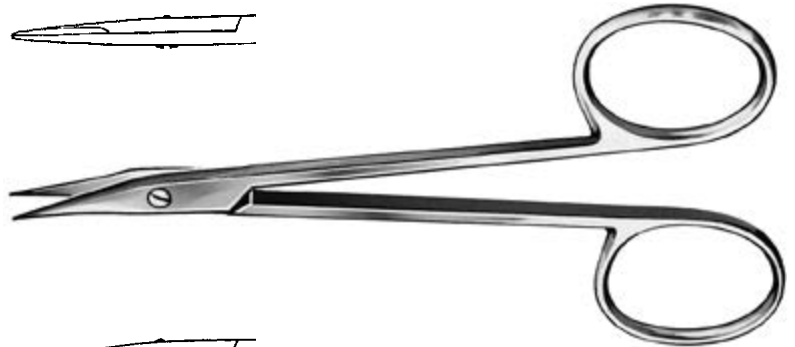
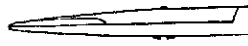

4601-03
STEVENS

10,5 cm
gebogen, stumpf/stumpf
curved, blunt tips
courbe, mousse
curvo, romo

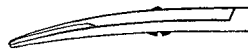

4601-01
STEVENS

10,5 cm
gebogen, spitz
curved, pointed
courbe, pointu
curvo, agudo

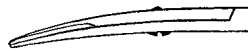

4604-03
STEVENS

11 cm
gerade, stumpf/stumpf
straight, blunt tips
droit, mousse
recto, romo

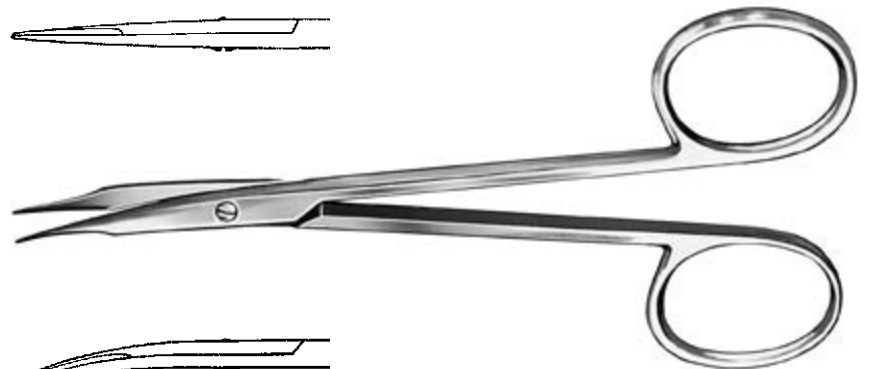
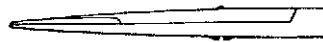

4605-03
STEVENS

11 cm
gebogen, stumpf/stumpf
curved, blunt tips
courbe, mousse
curvo, romo

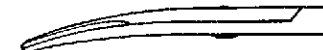

4605-01
STEVENS

11 cm
gebogen, spitz
curved, pointed
courbe, pointu
curvo, agudo

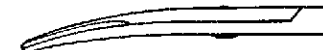

4610-03
STEVENS

11,5 cm
gerade, stumpf/stumpf
straight, blunt tips
droit, mousse
recto, romo

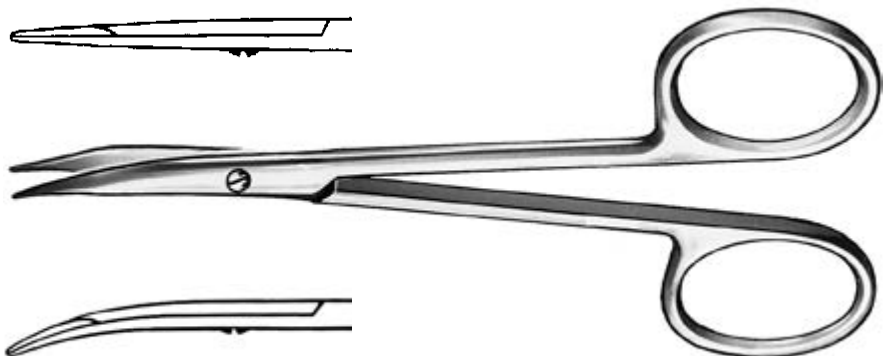
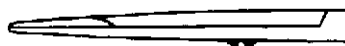

4611-03
STEVENS

11,5 cm
gebogen, stumpf/stumpf
curved, blunt tips
courbe, mousse
curvo, romo



STRABISMUSSCHEREN
STRABISMUS SCISSORS



CISEAUX À STRABISME
TIJERAS PARA ESTRABISMO

4622-03
HEIDELBERGER MODELL
9 cm
gerade
straight
droit
recto

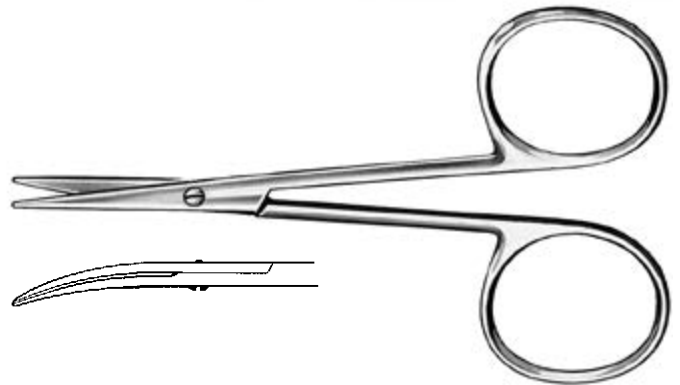

4623-03
HEIDELBERGER MODELL
9 cm
gebogen
curved
courbe
curvo

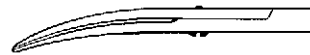

4628-03
10,5 cm
gerade
straight
droit
recto

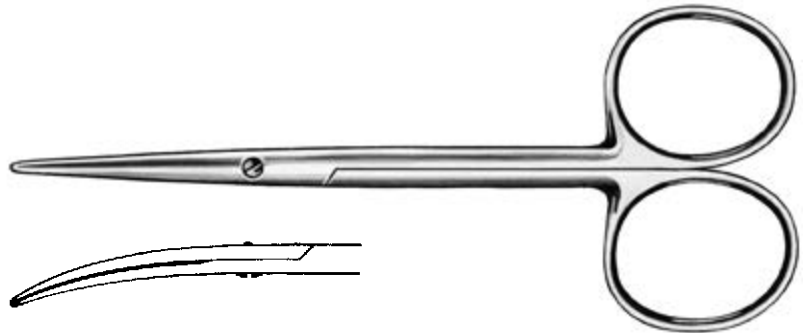

4629-03
10,5 cm
gebogen
curved
courbe
curvo

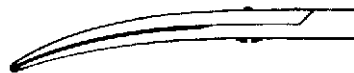

4628-13
10,5 cm
gerade
straight
droit
recto

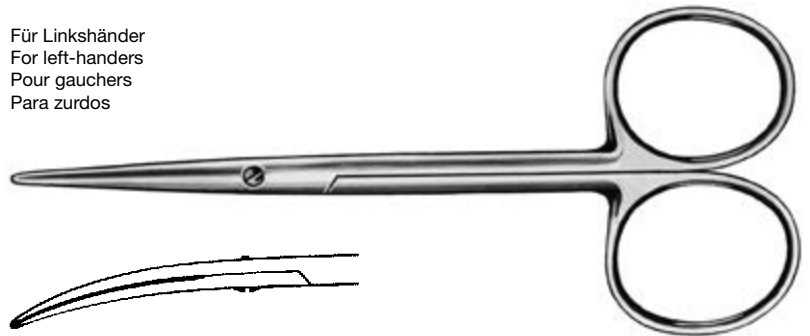

Für Linkshänder
For left-handers
Pour gauchers
Para zurdos

4629-13
10,5 cm
gebogen
curved
courbe
curvo

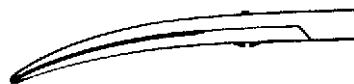

4632-03
10,5 cm
gerade
straight
droit
recto

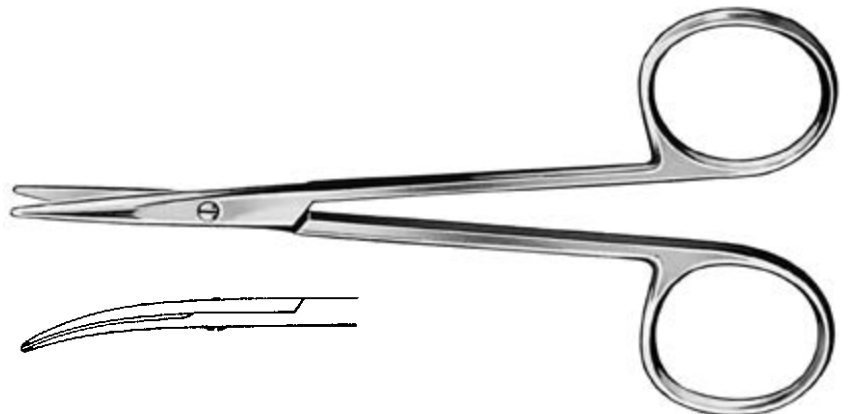

4633-03
10,5 cm
gebogen
curved
courbe
curvo

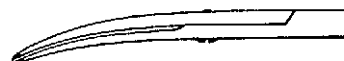

STRABISMUSSCHEREN
STRABISMUS SCISSORS



CISEAUX À STRABISME
TIJERAS PARA ESTRABISMO

4635-03

11 cm
gebogen
curved
courbe
curvo

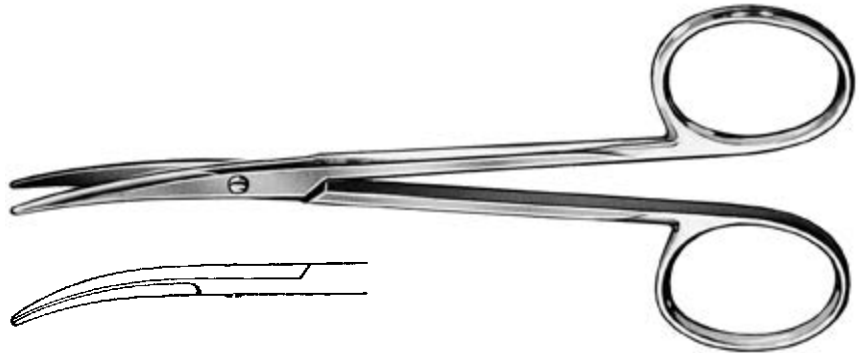

4640-03

12 cm
gerade
straight
droit
recto

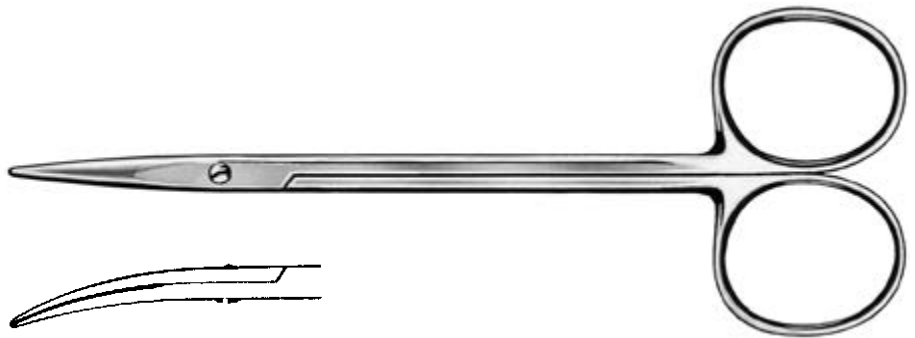

4641-03

12 cm
gebogen
curved
courbe
curvo



4644-03

12 cm
gerade
straight
droit
recto

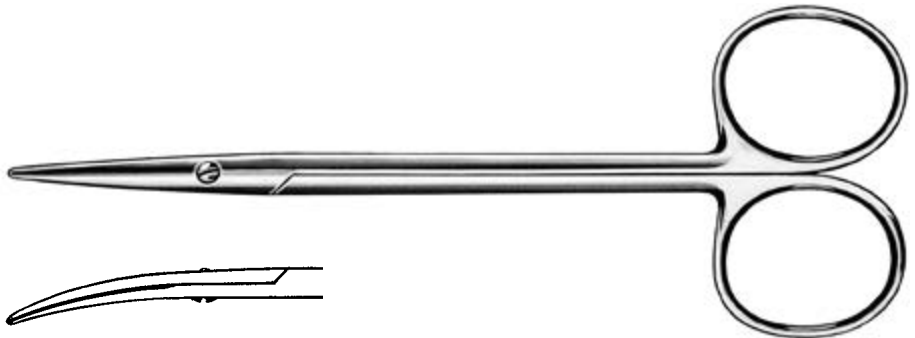

4645-03

12 cm
leicht gebogen
slightly curved
légèrement courbe
ligeramente curvo



4647-03

12 cm
stark gebogen
strong curved
très courbe
muy curvo



4648-00

10,5 cm
gerade
straight
droit
recto

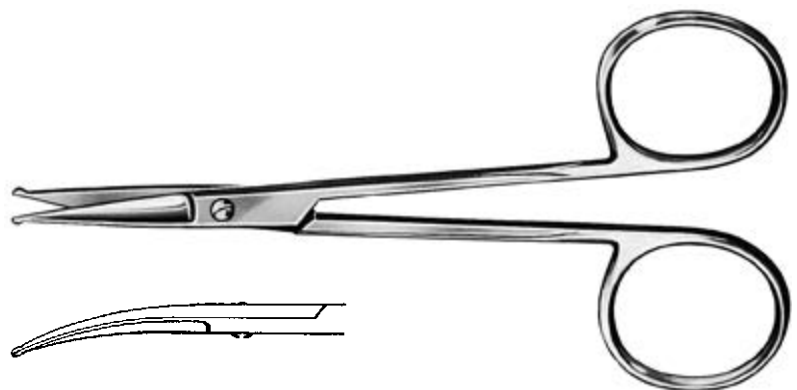

4649-00

10,5 cm
gebogen
curved
courbe
curvo

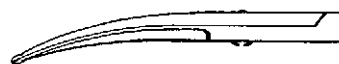

AUGENSCHEREN
EYE SCISSORS



CISEAUX OCULAIRES
TIJERAS OCULARES



4704-01

9 cm
gerade, straight, droit, recto



4704-03

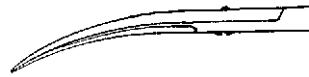
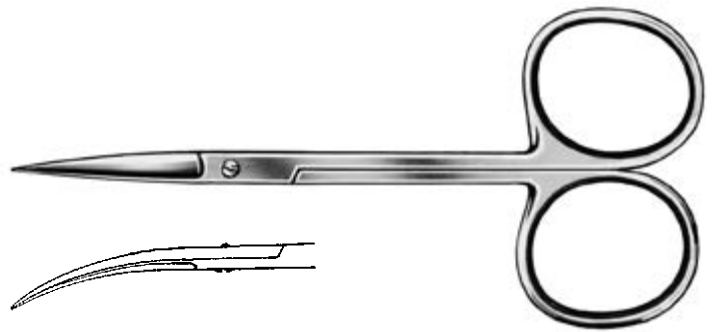

4705-01

9 cm
gebogen, curved, courbe, curvo



4705-03



4706-01

9,5 cm
gerade, straight, droit, recto



4706-03

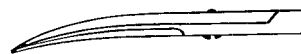
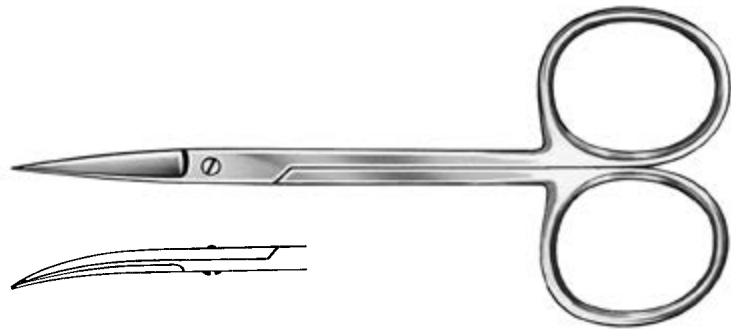

4707-01

9,5 cm
gebogen, curved, courbe, curvo



4707-03



4708-01

10,6 cm
gerade, straight, droit, recto



4708-02



4708-03

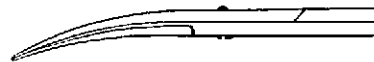
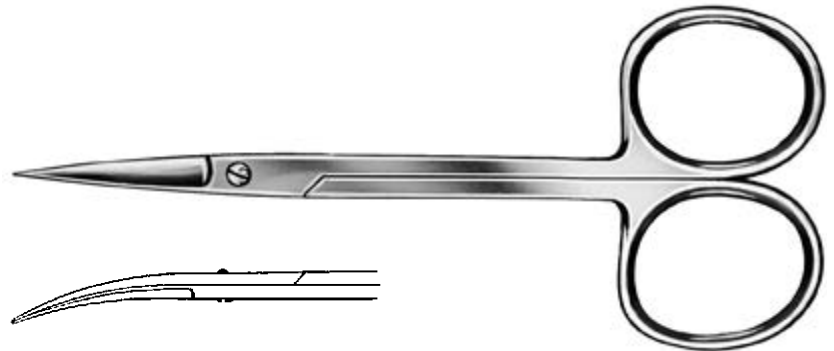

4709-01

10,6 cm
gebogen, curved, courbe, curvo



4709-02



4709-03



4710-01

11,5 cm
gerade, straight, droit, recto

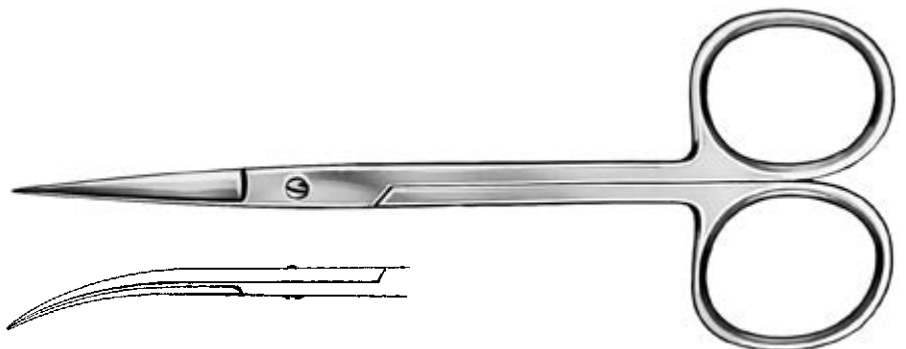

4711-01

11,5 cm
gebogen, curved, courbe, curvo



4711-03

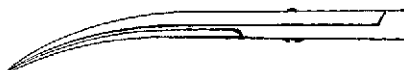

AUGENSCHEREN
EYE SCISSORS



CISEAUX OCULAIRES
TIJERAS OCULARES



4712-01 4712-02 4712-03
11,5 cm
gerade, straight, droit, recto



4713-01 4713-03
11,5 cm
gebogen, curved, courbe, curvo

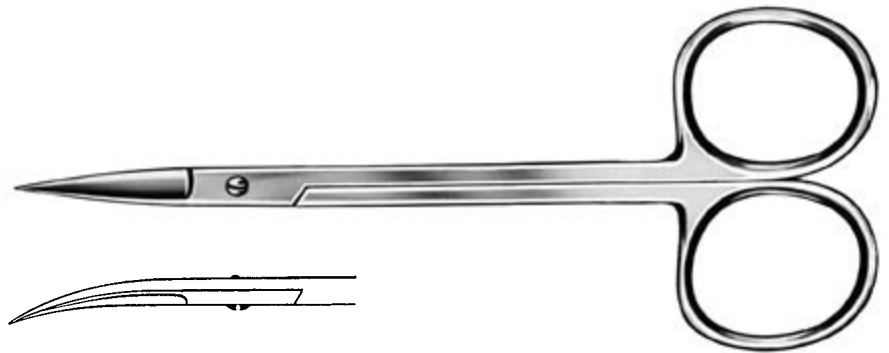

4714-01
10,3 cm
gerade, straight, droit, recto



4715-01
10,3 cm
gebogen, curved, courbe, curvo

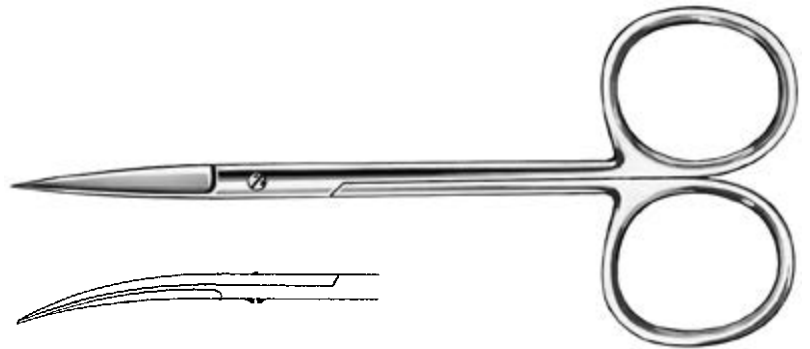

4718-01 4718-02 4718-03
12,5 cm
gerade, straight, droit, recto



4719-01 4719-02 4719-03
12,5 cm
gebogen, curved, courbe, curvo

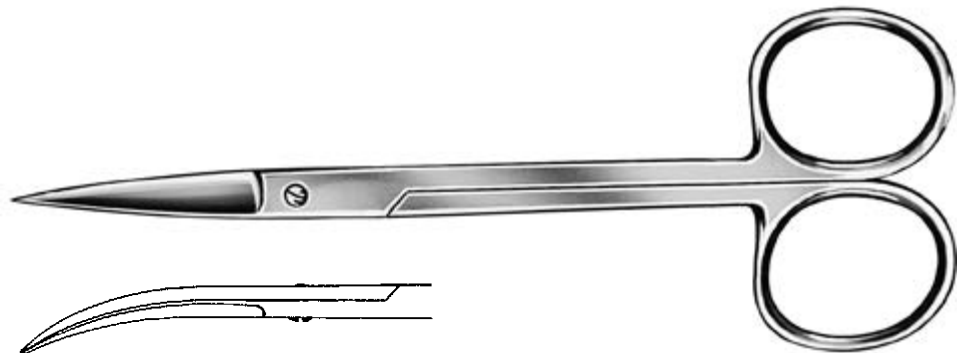

4720-01 4720-02 4720-03
BONNER MODELL
8,8 cm
gerade, straight, droit, recto



4721-01 4721-02 4721-03
BONNER MODELL
8,8 cm
gebogen, curved, courbe, curvo

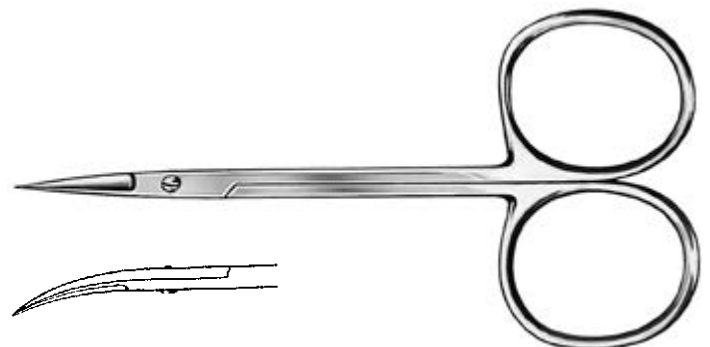

AUGENSCHEREN
EYE SCISSORS



CISEAUX OCULAIRES
TIJERAS OCULARES

4752-01
10 cm
gerade, straight, droit, recto

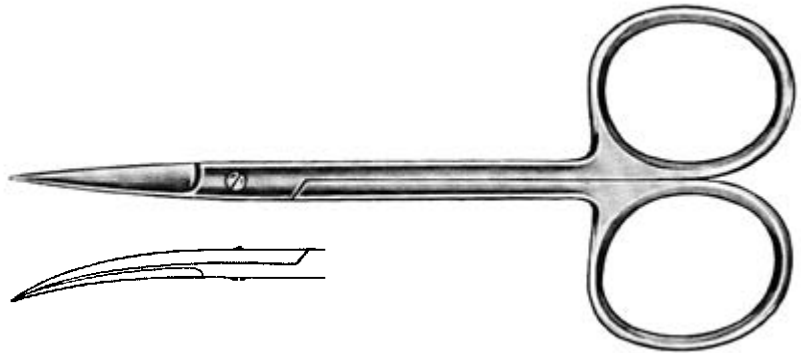

4753-01
10 cm
gebogen, curved, courbe, curvo

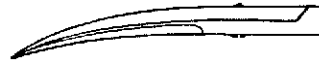

4752-11
10 cm
gerade, straight, droit, recto

Für Linkshänder
For left-handers
Pour gauchers
Para zurdos

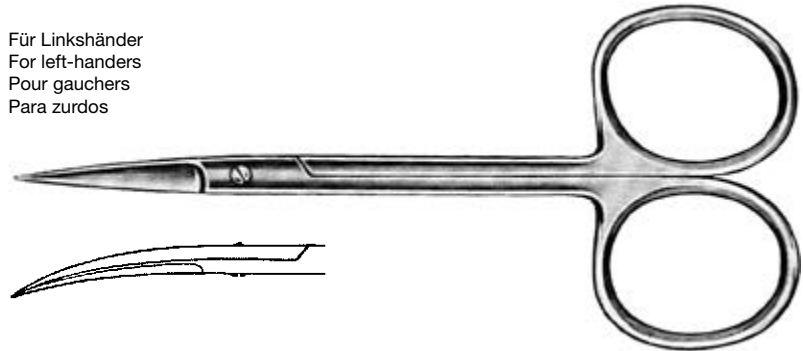

4753-11
10 cm
gebogen, curved, courbe, curvo

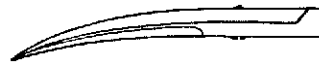

4754-01
11 cm
gerade, straight, droit, recto

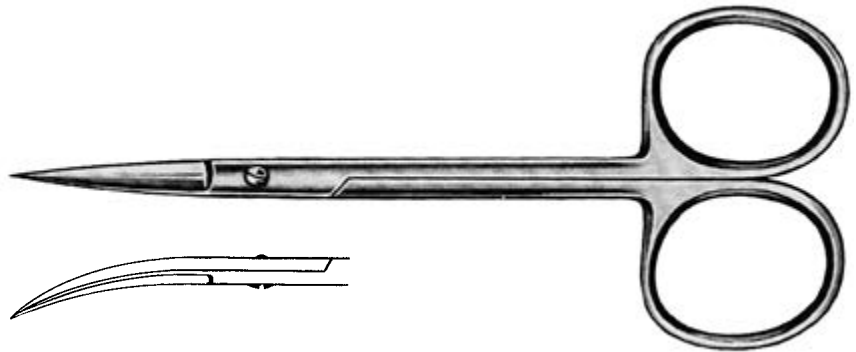

4755-01
11 cm
gebogen, curved, courbe, curvo

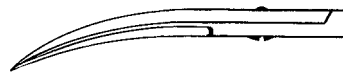

4758-01
12 cm
gerade, straight, droit, recto

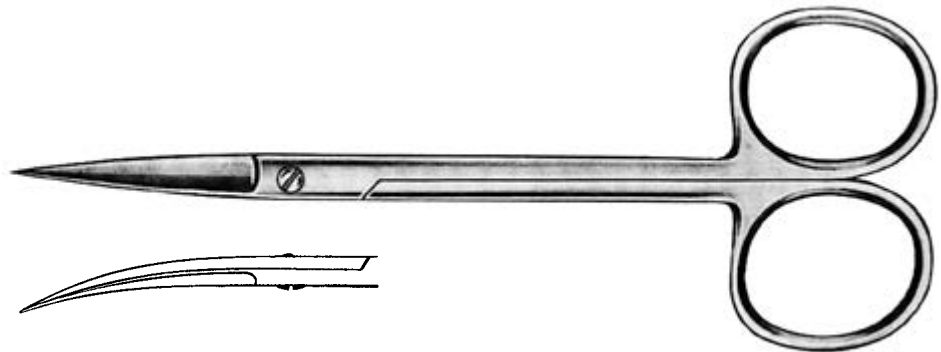

4759-01
12 cm
gebogen, curved, courbe, curvo

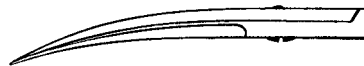

AUGENSCHEREN
EYE SCISSORS



CISEAUX OCULAIRES
TIJERAS OCULARES

4762-01

10 cm
gerade, straight, droit, recto

mit extra großen Ringen
with special large rings
anneaux extrêmement rings
argollas muy grande

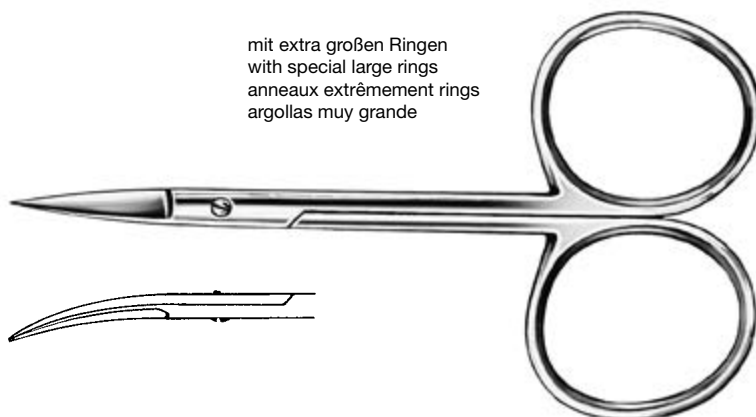

4763-01

10 cm
gebogen, curved, courbe, curvo

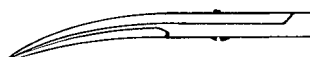

4771-01

WILMER
9,5 cm
aufgewinkelt, gezahnt
angled on flat, serrated
angulaire, striée
angulado, estriada

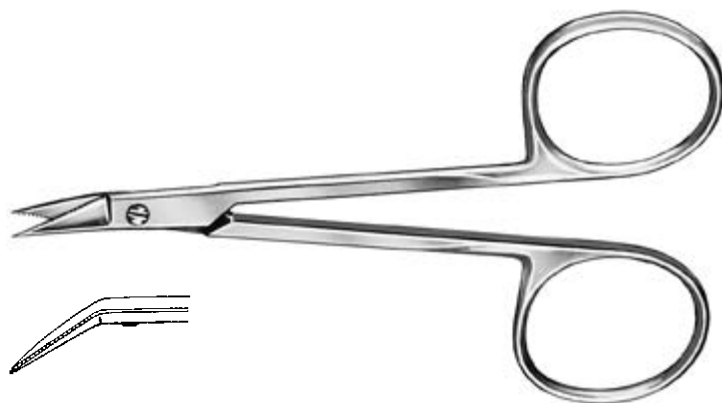

4773-03
GRAEFE (WALTER)

10 cm
aufgewinkelt
angled on flat
angulaire
angulado

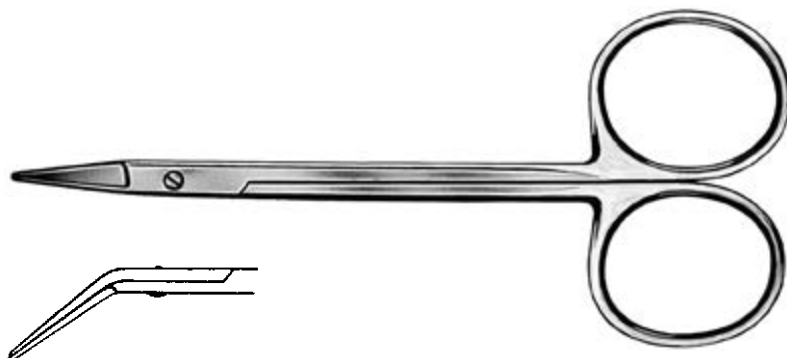

4774-03

GRAEFE
10 cm
kniegebogen
angled to side
coudé
anguloso

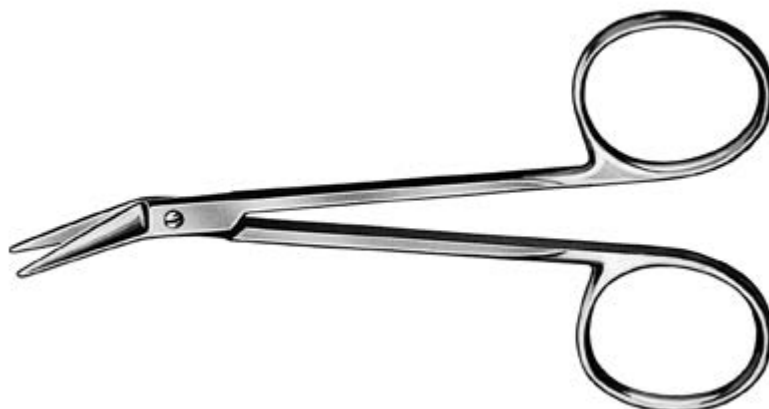

AUGENSCHEREN
EYE SCISSORS



CISEAUX OCULAIRES
TIJERAS OCULARES

4779-01
LAGRANGE
11,5 cm
gebogen
curved
courbe
curvo

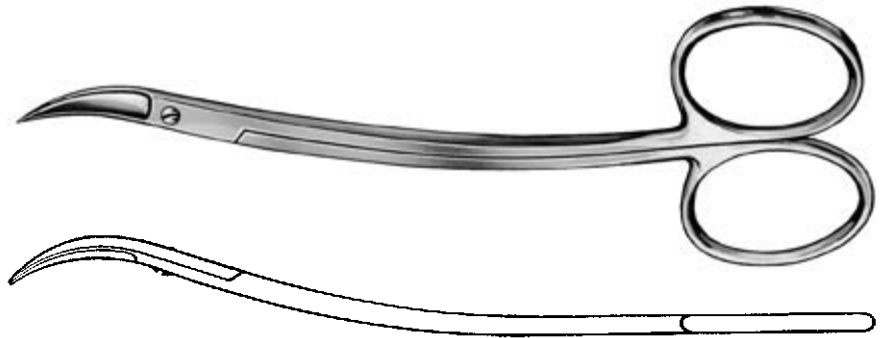

4780-01
10 cm

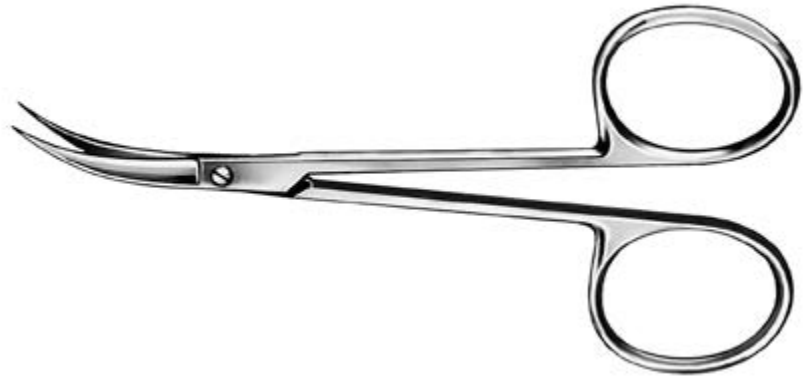

4823-03
AEBLI
9,8 cm
aufgewinkelt
angled on flat
angulaire
angulado

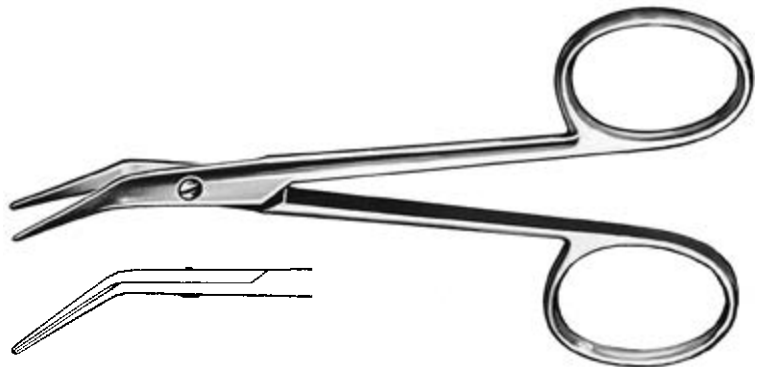

4824-03
AEBLI
9,8 cm
gerade
straight
droit
recto

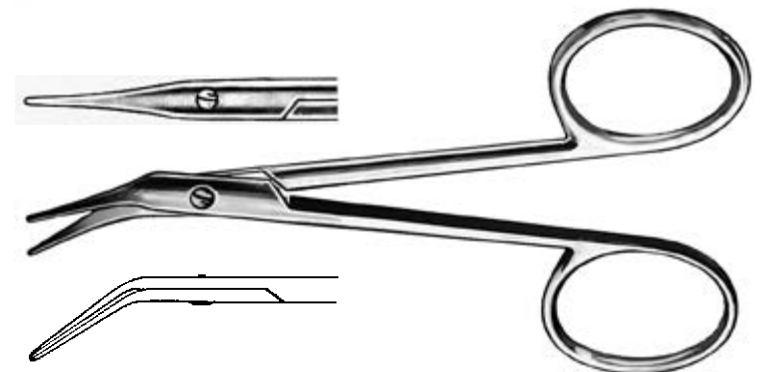

4825-13
AEBLI
9,8 cm
aufgewinkelt
angled on flat
angulaire
angulado

AUGENSCHEREN
EYE SCISSORS



CISEAUX OCULAIRES
TIJERAS OCULARES

4830-01

11,5 cm
kniegebogen
angled to side
coudé
angulado

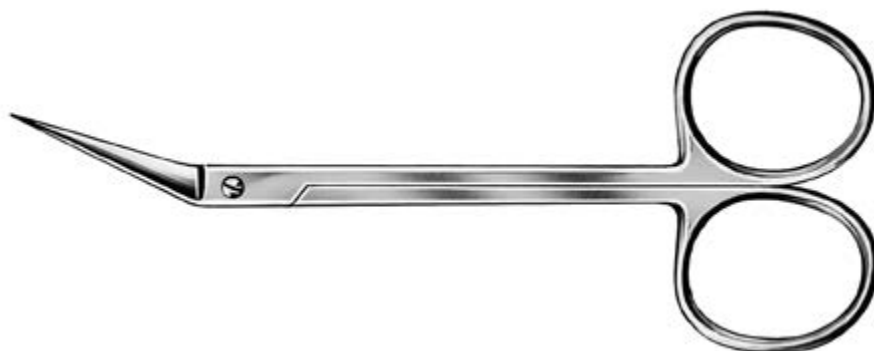

4832-00

11,5 cm
kniegebogen
angled to side
coudé
angulado



4834-00

11,5 cm
kniegebogen
angled to side
coudé
angulado



4835-03

Mc GUIRE
10,5 cm



4837-13

Mc GUIRE
10,5 cm



FADENSCHERE
STITCH SCISSORS



CISEAUX POUR INCISION
TIJERAS PARA INCISIÓN

4006-41

11 cm
gerade
straight
droit
recto
matt



4844-42

mit Kerbe für den Faden
Spencer-type notch
avec entaille pour le fil
con muesca para el hilo



4840-00
SPENCER
9 cm



4842-00
SPENCER
11 cm



4847-01
9,5 cm
gebogen
curved
courbe
curvo

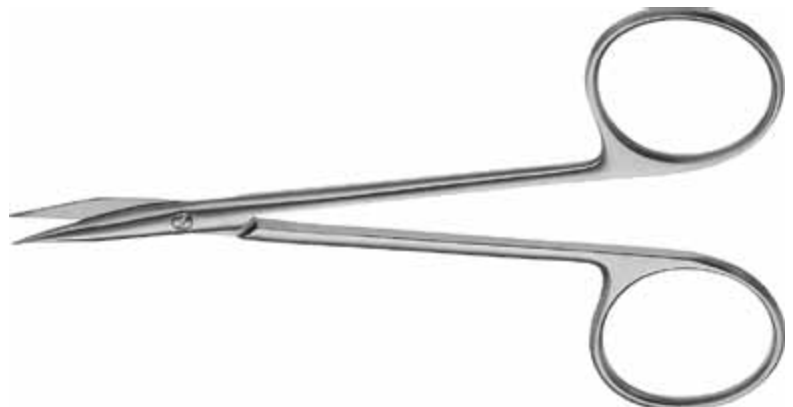

ENUKLEATIONSSCHEREN
ENUCLEATION SCISSORS



CISEAUX À ÉNUCLÉER
TIJERAS PARA ENUCLEACIÓN

4854-03

12 cm
gerade
straight
droit
recto

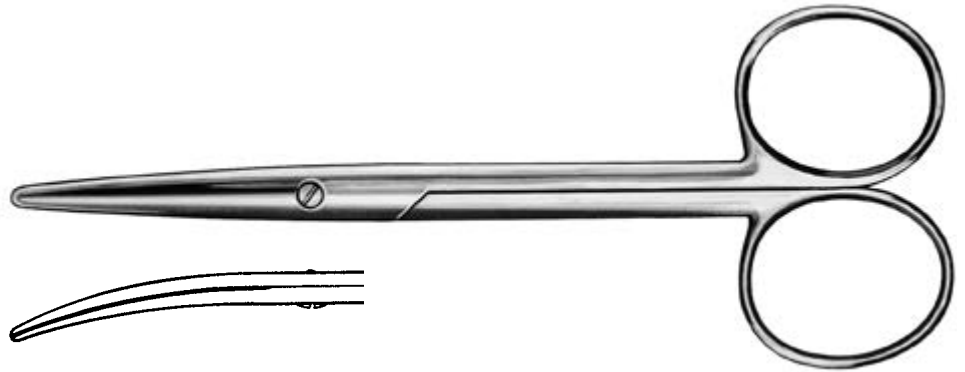

4855-03

12 cm
leicht gebogen
slightly curved
légèrement courbe
ligeramente curvo

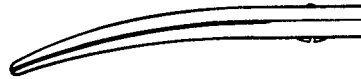

4857-03

12 cm
mittel gebogen
medium curved
moyennement courbe
medio curvo



4859-03

12 cm
stark gebogen
strong curved
très courbe
muy curvo



4864-03

13 cm
gerade
straight
droit
recto

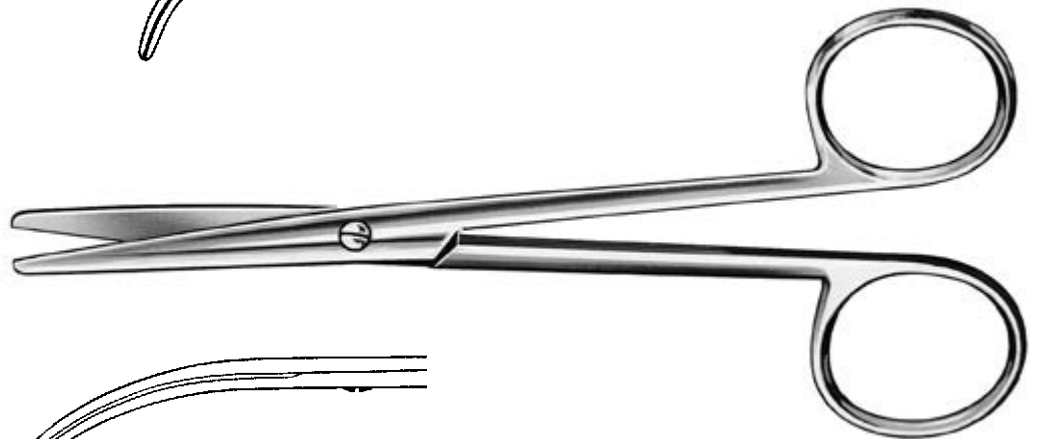

4865-03

13 cm
leicht gebogen
slightly curved
légèrement courbe
ligeramente curvo



4867-03

13 cm
mittel gebogen
medium curved
moyennement courbe
medio curvo



4869-03

13 cm
stark gebogen
strong curved
très courbe
muy curvo



4879-03

11,5 cm
für Kinder
for children
pour enfants
para niños

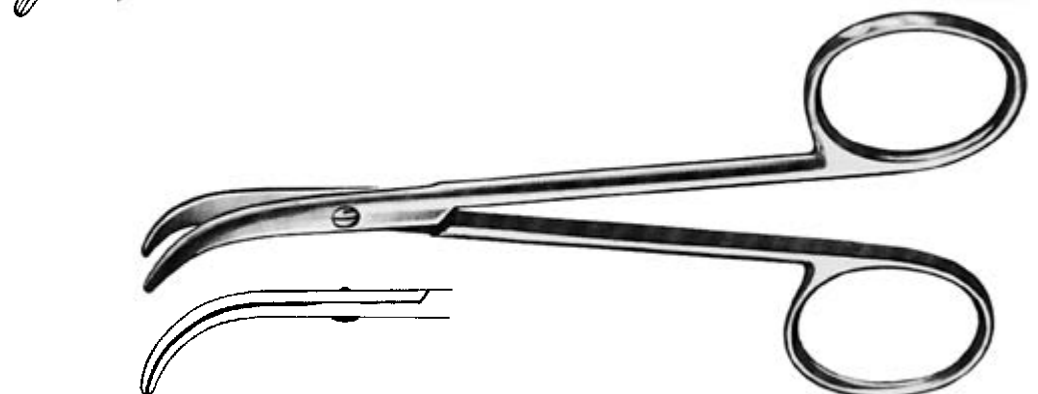

4900-00
HEIMANN
11 cm
gerade
straight
droit
recto



4904-00 kniegebogen 60°
angled to side 60°
coudé 60°
angulado 60°



4906-00 kniegebogen 90°
angled to side 90°
coudé 90°
angulado 90°



4911-00 über die Fläche gewinkelt 30°
angled on flat 30°
coudé à plat 30°
angulato sobre el plano 30°



Verschiedene Pinzetten in gleicher Bauart, mit glattem Maul, gerieftem Maul oder löffelförmigem Maul, in 30°, 60° oder 90°, kniegebogen oder über die Fläche gewinkelt, sind auf Wunsch lieferbar.

Forceps of same pattern, with plain jaws, serrated jaws or cups, straight, angled sideways or on flat, 30°, 60° or 90°, are available upon request.

En option, diverses pinces de même type, à mâchoires lisses, cannelées ou en forme curette, à 30°, 60° ou 90°, angulaire ou coudées à plat.

Si se desea, se pueden suministrar también diversos pinzas del mismo tipo, de boca lisa, estriada o de forma acucharada, en 30°, 60° ó 90°, rectas, acodadas o anguladas sobre el plano.

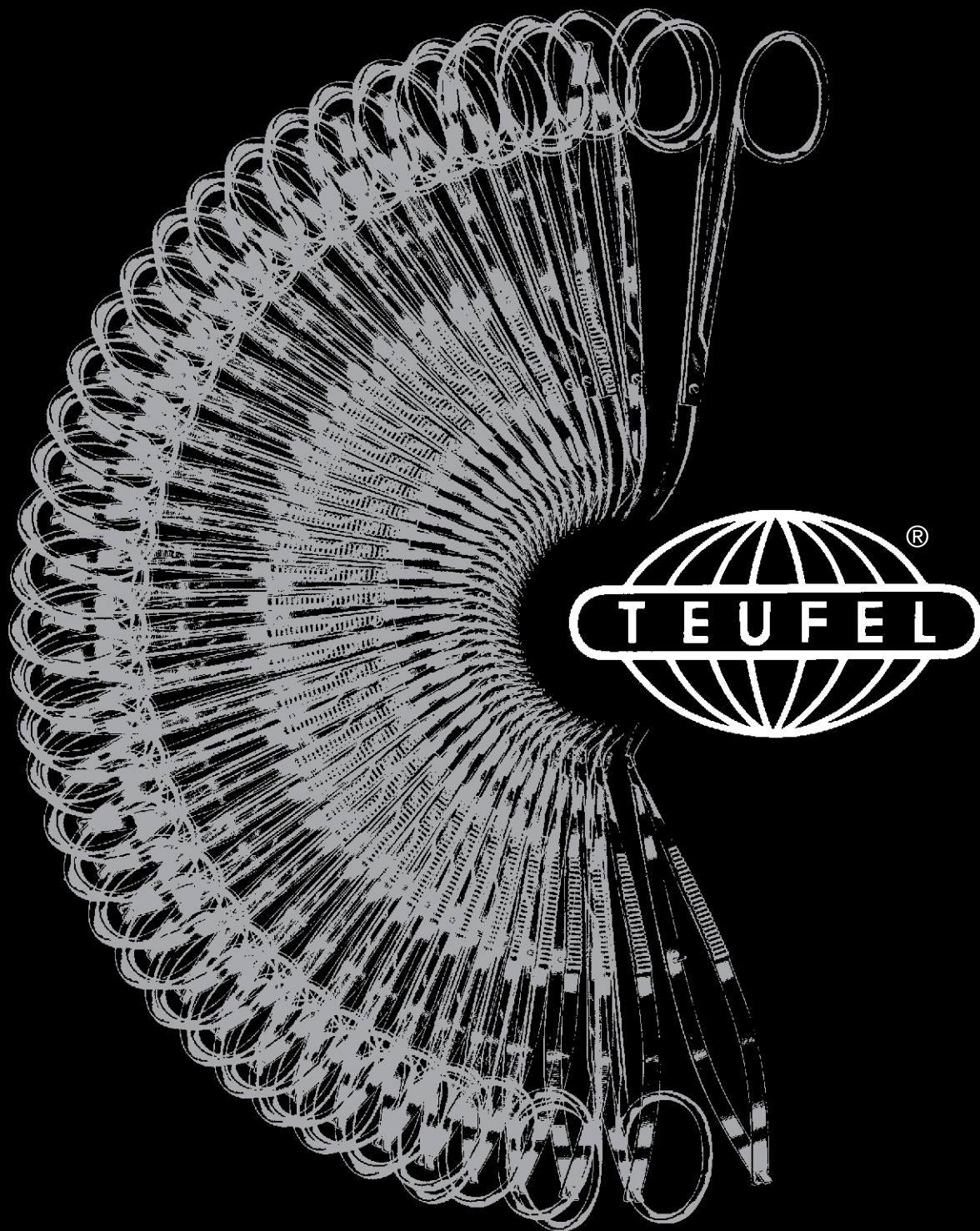

**CHIRURGISCHE
SCHEREN**

**OPERATING
SCISSORS**

**CISEAUX
À CHIRURGIE**

**TIJERAS
PARA CIRUGIA**



Die meisten Scheren können wir auch in Supercut-Ausführung liefern. Die messerscharfe Schneide schneidet weich und mühelos auch durch dickes Material, die gezahnte Schneide (Wellenschliff) auf der anderen Seite verhindert daß das zu schneidene Material weggleitet. Zur leichteren Identifizierung haben Supercut-Scheren eine kratzfeste, schwarze Beschichtung der Griffbranchen.

Supercut ist nicht geeignet für Drähte, Knorpel und anderes hartes Material.

Bei Anfragen geben sie bitte die Artikelnummer des Normalmodelles an. Wir nennen Ihnen dann gerne den Preis und die Liefermöglichkeit für die Supercut-Ausführung.

We can also supply most scissors in Supercut version. The razor-sharp cutting edge cuts smoothly and effortlessly even through thick materials, the serrated cutting edge on the other cutting edge prevents the material from slipping. Supercut scissors have a scratchresistant, black coating on the handles for easier identification.

Supercut is not suitable for wires, cartilage and other hard materials.

Please state the article number of the standard model with any enquiry. We will then gladly quote the price and specify the availability of the Supercut version.

Nous pouvons également livrer la plupart des ciseaux en exécution Supercut. La lame tranchante permet de couper également, en douceur et sans effort, un matériau épais. La lame dentelée (rectification andulée), de l'autre côté, empêche le matériau à couper de glisser. Pour faciliter leur identification, les ciseaux Supercut comportent sur les branches un marquage noir et résistant aux rayures.

Supercut ne convient pas pour les fils métallique, cartilages et autres matériaux durs.

Sur vos demandes, nous vous prions de bien vouloir indiquer le numéro d'article de modèle normal. Nous vous communiquerons alors le prix et les possibilités de livraison du modèle Supercut.

La mayoría de las tijeras las podemos suministrar en la versión Supercut. La hoja de la tijera lisa y afilada corta suavemente y sin problemas, inclusive materiales gruesos, la contrahoja dentada de la tijera, con filo ondulado impide que el material por cortar resbale. Para identificarlas mejor, los mangos de las tijeras Supercut llevan un recubrimiento negro resistente a las rayaduras.

Las tijeras Supercut no son apropiadas para cortar alambres, materiales cartilaginosos y otros tipos de materiales duros.

En sus requisiciones suministrenos por favor el número del artículo del modelo normal y nosotros con gusto le informaremos el precio y las posibilidades de suministro de la versión Supercut.

NASENSCHEREN
NASAL SCISSORS



CISEAUX POUR LE NEZ
TIJERAS NASALES

4604-03
STEVENS
11,5 cm
gerade, stumpf/stumpf
straight, blunt tips
droit, mousse
recto, romo

4604D03
STEVENS, Supercut
11,5 cm
gerade, stumpf/stumpf
straight, blunt tips
droit, mousse
recto, romo

4605-03
STEVENS
11,5 cm
gebogen, stumpf/stumpf
curved, blunt tips
courbe, mousse
curvo, romo

4605D03
STEVENS, Supercut
11,5 cm
gebogen, stumpf/stumpf
curved, blunt tips
courbe, mousse
curvo, romo

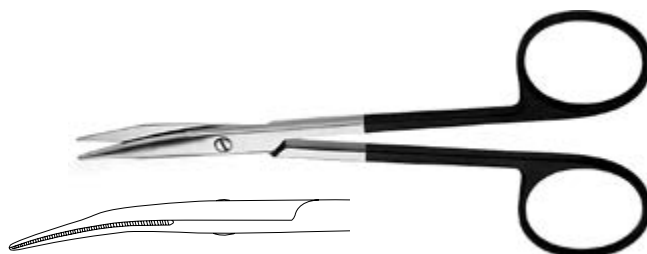

4612D03
STEVENS, Supercut
14 cm
gerade, stumpf/stumpf
straight, blunt tips
droit, mousse
recto, romo

4613D03
STEVENS, Supercut
14 cm
gebogen, stumpf/stumpf
curved, blunt tips
courbe, mousse
curvo, romo

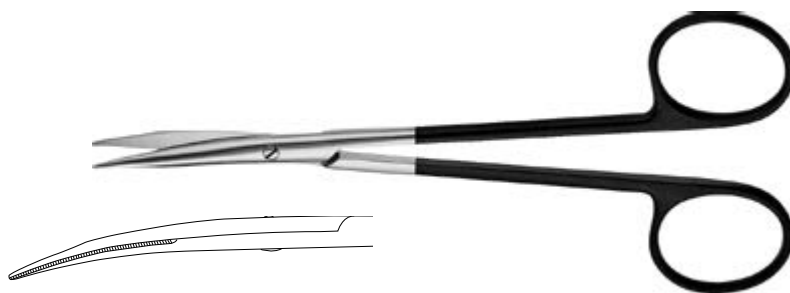

4644D03
Supercut
12 cm
gerade, stumpf/stumpf
straight, blunt tips
droit, mousse
recto, romo

4645D03
Supercut
12 cm
gebogen, stumpf/stumpf
curved, blunt tips
courbe, mousse
curvo, romo

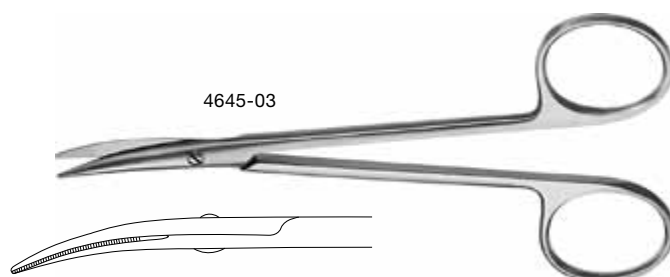

4708D01
Supercut
10,6 cm
gerade, spitz/spitz
straight, sharp tips
droit, pointu
recto, agudo

4709D01
Supercut
10,6 cm
gebogen, spitz/spitz
curved, sharp tips
courbe, pointu
curvo, agudo

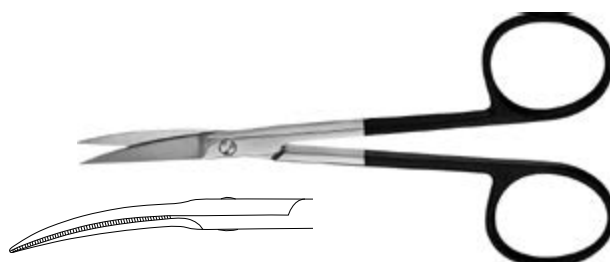

NASENSCHEREN
NASAL SCISSORS



CISEAUX POUR LE NEZ
TIJERAS NASALES

5300-03
HEYMANN
16 cm



5304-03
HEYMANN
16,5 cm



5306-03
HEYMANN
18 cm

großes Modell
large pattern
grand modèle
modelo grande



5312-03
KNIGHT
17 cm



NASENSCHEREN
NASAL SCISSORS



CISEAUX POUR LE NEZ
TIJERAS NASALES

5326-23
FOMON, TC
14 cm
mit Hartmetallschneide
with tungsten carbide cutting edge
avec tranchants de tungstène
con filos de carburo de tungsteno

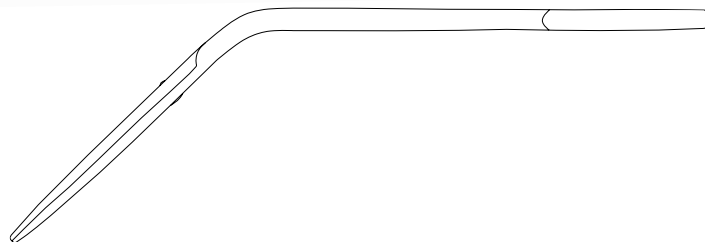

5328-03
FOMON
14 cm

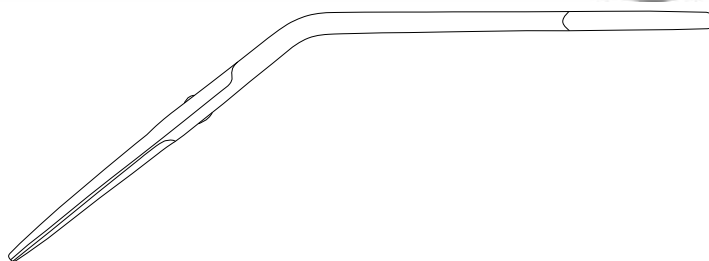

5330-03
COTTLE
16 cm



5330-23
COTTLE, TC
16 cm
mit Hartmetallschneide
with tungsten carbide cutting edge
avec tranchants de tungstène
con filos de carburo de tungsteno

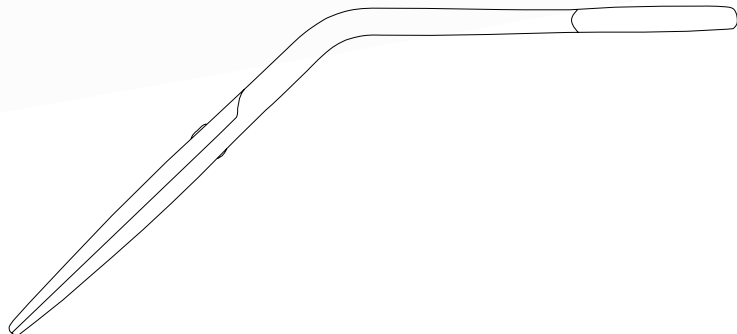

NASENSCHEREN
NASAL SCISSORS



CISEAUX POUR LE NEZ
TIJERAS NASALES

5332-03
FOMON
13 cm

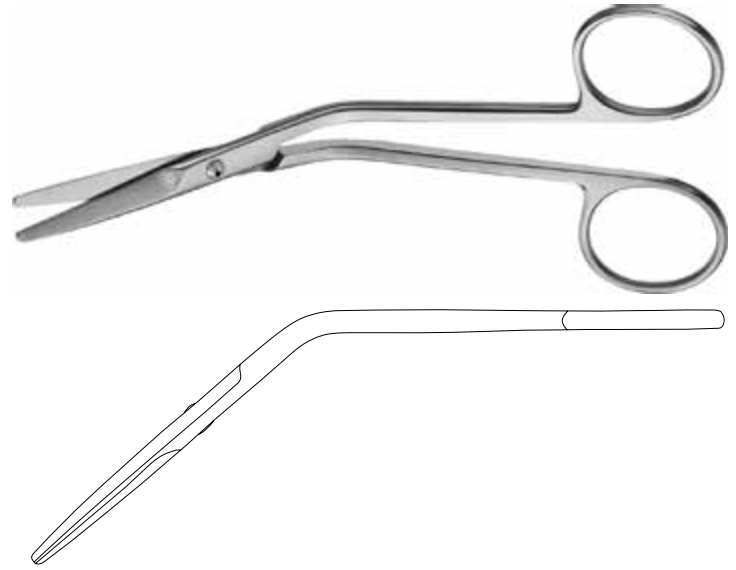

5335-03
COTTLE BULLDOG
14,5 cm
gebogen, stumpf/stumpf
curved, blunt tips
courbe, mousse
curvo, romo

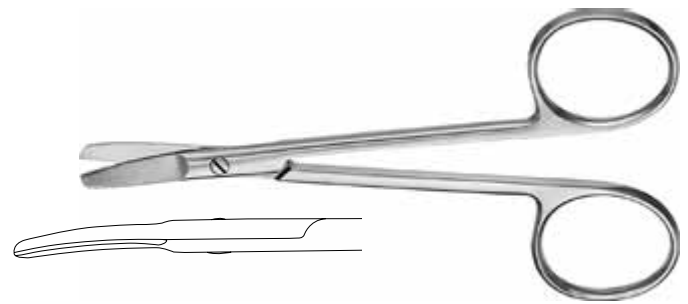

5337-03
HEYMANN
11,5 cm
stark gebogen
strong curved
très courbé
muy curvo

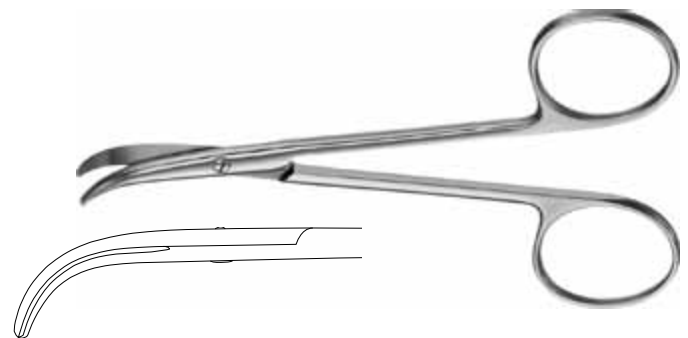

5340-01
JOSEPH
14,5 cm
gerade, spitz/spitz
straight, sharp tips
droit, pointu
recto, agudo

5341-01
JOSEPH
14,5 cm
gebogen, spitz/spitz
curved, sharp tips
courbe, pointu
curvo, agudo

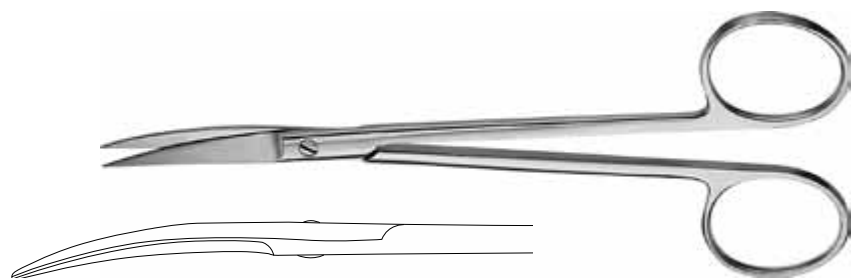

NASENSCHEREN
NASAL SCISSORS



CISEAUX POUR LE NEZ
TIJERAS NASALES

5342-01
PECK-JOSEPH
14,5 cm
gerade, spitz/spitz
straight, sharp tips
droit, pointu
recto, agudo

5342-03
PECK-JOSEPH
14,5 cm
gerade, stumpf/stumpf
straight, blunt tips
droit, mousse
recto, romo

5343-01
PECK-JOSEPH
14,5 cm
gebogen, spitz/spitz
curved, sharp tips
courbe, pointu
curvo, agudo

5343-03
PECK-JOSEPH
14,5 cm
gebogen, stumpf/stumpf
curved, blunt tips
courbe, mousse
curvo, romo

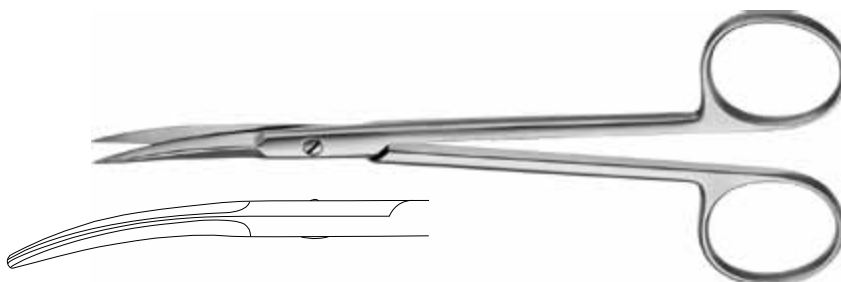

5349-03
FOMON
13 cm
gebogen, stumpf/stumpf
curved, blunt tips
courbe, mousse
curvo, romo

5349-23
FOMON, TC
13 cm
gebogen, stumpf/stumpf
curved, blunt tips
courbe, mousse
curvo, romo

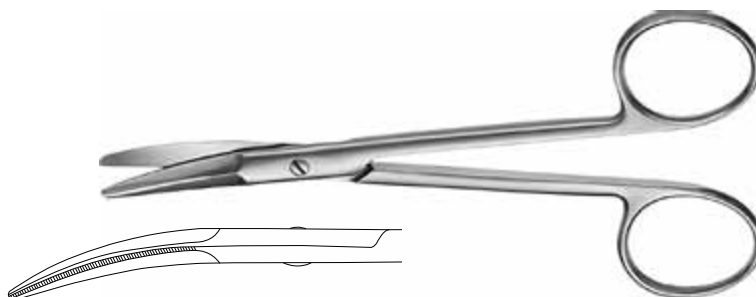

5351-03
FOMON
12 cm
gebogen, stumpf/stumpf
curved, blunt tips
courbe, mousse
curvo, romo

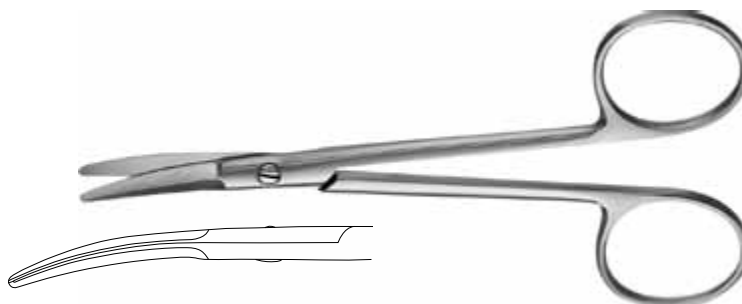

5353-03
FOMON
17 cm
stark gebogen
strong curved
très courbé
muy curvo

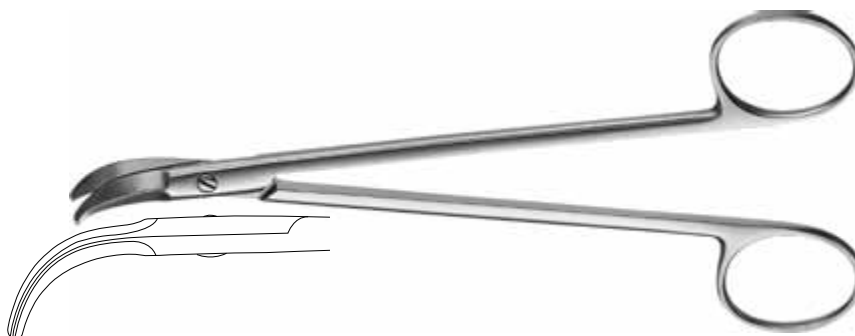

5355-03
SHEA
12 cm
gebogen, stumpf/stumpf
curved, blunt tips
courbe, mousse
curvo, romo

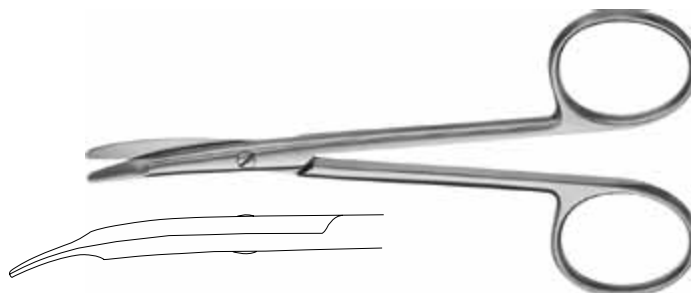

NASENSCHEREN
NASAL SCISSORS



CISEAUX POUR LE NEZ
TIJERAS NASALES

5357-03

KILNER

13,5 cm

gebogen, stumpf/stumpf
curved, blunt tips
courbe, mousse
curvo, romo

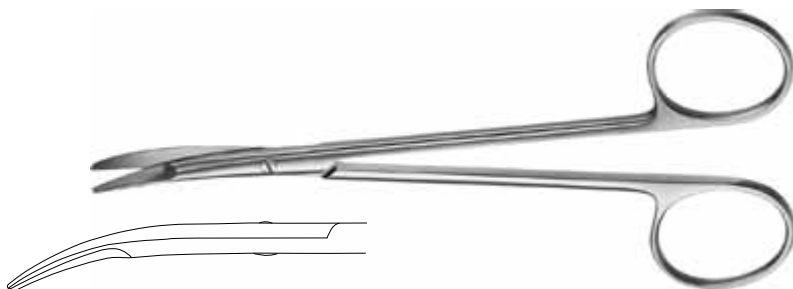

5369-03

FOMON

13 cm

stark gebogen
strong curved
très courbé
muy curvo

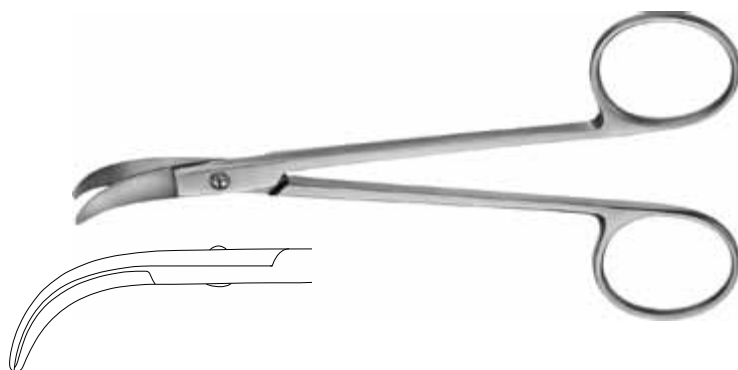

TONSILLENSCHEREN

TONSIL SCISSORS



CISEAUX POUR LES AMYGDALES

TIJERAS PARA AMIGDALAS



**5365-01
BOETTCHER**

18 cm
gebogen, spitz/spitz
curved, sharp tips
courbe, pointu
curvo, agudo



**5365-03 (= normal)
BOETTCHER**

18 cm
gebogen, stumpf/stumpf
curved, blunt points
courbe, mousse
curvo, romo

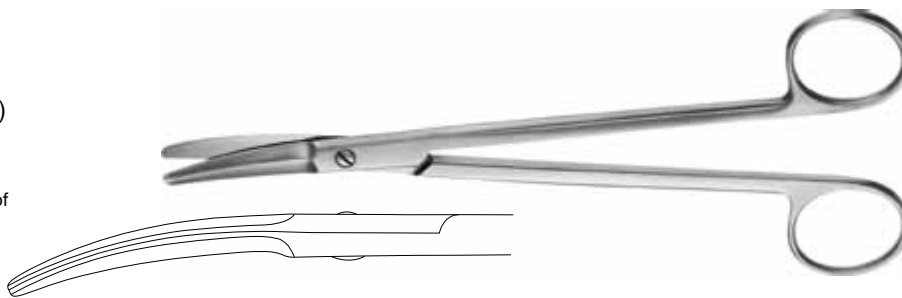

**5367-03
MUCK**

18 cm
stark gebogen
strong curved
très courbé
muy curvo

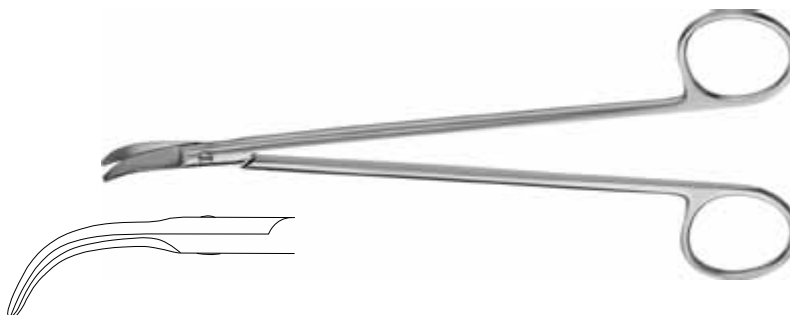

**5369-03
FOMON**

13 cm
stark gebogen
strong curved
très courbé
muy curvo

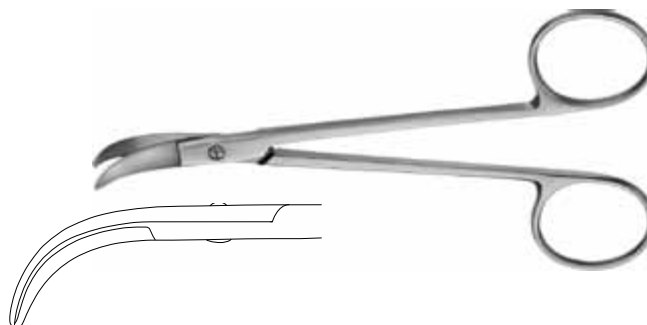

**5385-03
GOOD-SCHWECKENDIECK**

19 cm
gezahnt
serrated
striée
estriada

**5387-03
GOOD**

19 cm

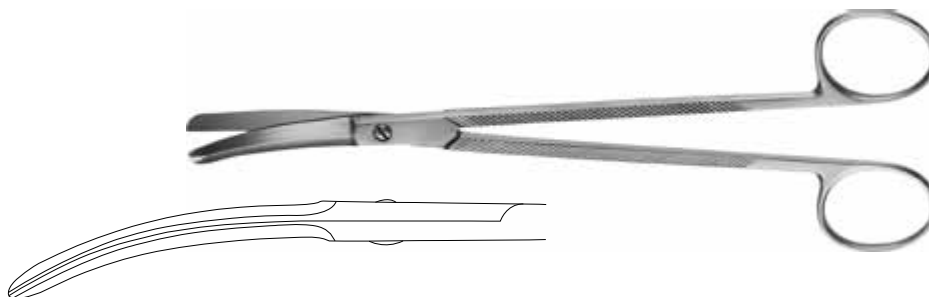

**5388-03
DEAN**

17 cm
gezahnt
serrated
striée
estriada

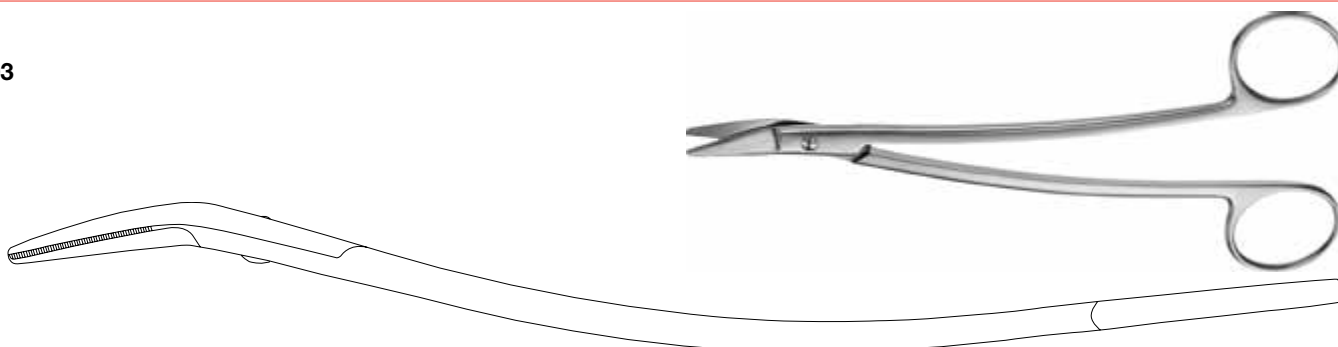

TONSILLENSCHEREN
TONSIL SCISSORS



CISEAUX POUR LES AMYGDALES
TIJERAS PARA AMIGDALAS

5445-03
METZENBAUM
14,5 cm
gebogen, stumpf/stumpf
curved, blunt tips
courbe, mousse
curvo, romo

5445-23
METZENBAUM, TC
14,5 cm
gebogen, stumpf/stumpf
curved, blunt tips
courbe, mousse
curvo, romo

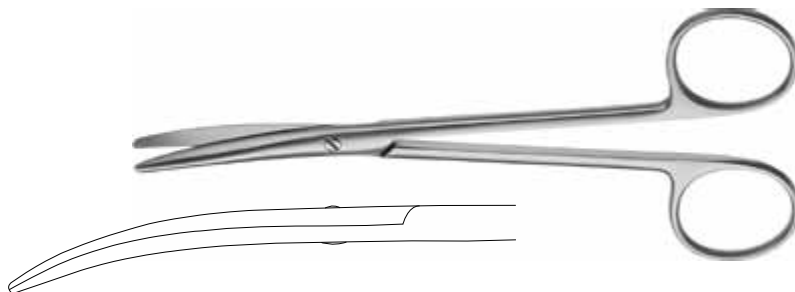

5473-03
METZENBAUM
18 cm
gebogen
curved
courbe
curvo

5473-23
METZENBAUM, TC
18 cm
gebogen
curved
courbe
curvo



METZENBAUM SCHEREN
METZENBAUM SCISSORS



CISEAUX METZENBAUM
TIJERAS METZENBAUM

5415-03
 METZENBAUM, fino
 12 cm
 gebogen
 curved
 courbe
 curvo

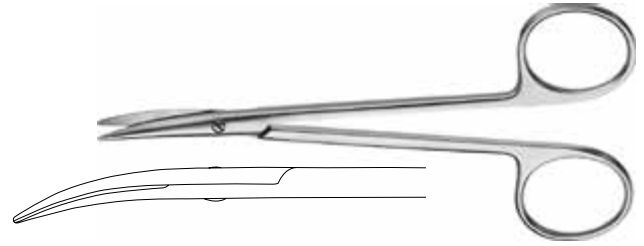

5418-03
 METZENBAUM, fino
 14,5 cm
 gerade
 straight
 droit
 recto

5418-23
 METZENBAUM, fino, TC
 14,5 cm
 gerade
 straight
 droit
 recto

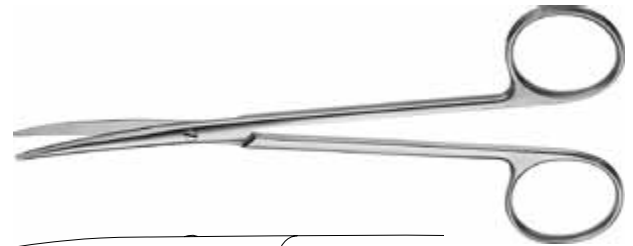

5419-03
 METZENBAUM, fino
 14,5 cm
 gebogen
 curved
 courbe
 curvo

5419-23
 METZENBAUM, fino, TC
 14,5 cm
 gebogen
 curved
 courbe
 curvo



5423-03
 METZENBAUM, fino
 18 cm
 gebogen
 curved
 courbe
 curvo

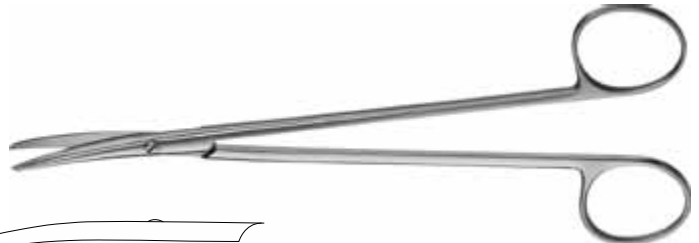

5426-03
 METZENBAUM, fino
 20 cm
 gerade
 straight
 droit
 recto



5429-03
 METZENBAUM, fino
 23 cm
 gebogen
 curved
 courbe
 curvo

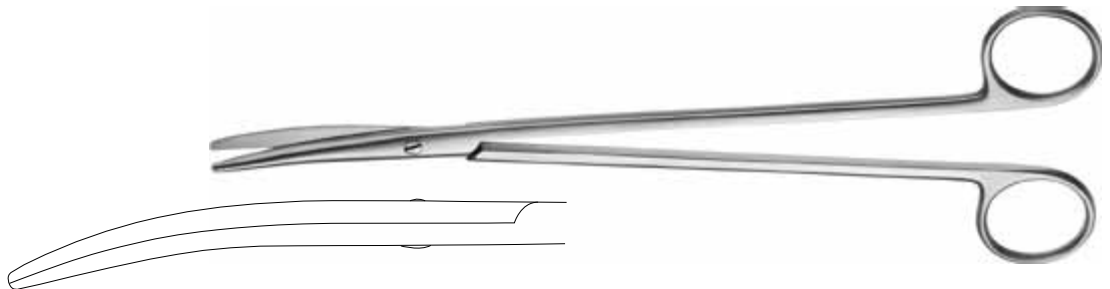

METZENBAUM, fino

gerade, straight, droit, recto
 gebogen, curved, courbe, curvo

25 cm

5430-03

5431-03

28 cm

5432-03

5433-03

30,5 cm

5434-03

32,5 cm

5436-03

5437-03

36,5 cm

5438-03

METZENBAUM SCHEREN
METZENBAUM SCISSORS



CISEAUX METZENBAUM
TIJERAS METZENBAUM

5441-03
METZENBAUM

12 cm
gebogen
curved
courbe
curvo

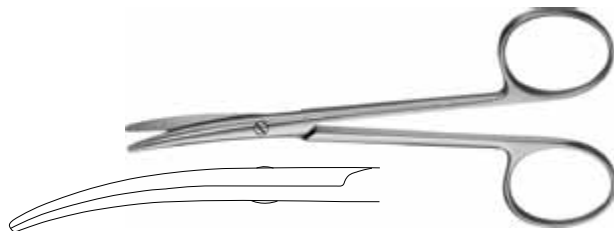

5444-03
METZENBAUM

14,5 cm
gerade
straight
droit
recto

5444-23
METZENBAUM, TC

14,5 cm
gerade
straight
droit
recto

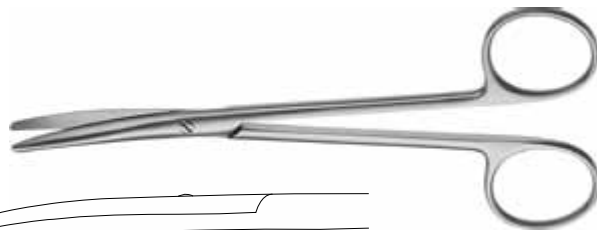

5445-03
METZENBAUM

14,5 cm
gebogen
curved
courbe
curvo

5445-23
METZENBAUM, TC

14,5 cm
gebogen
curved
courbe
curvo

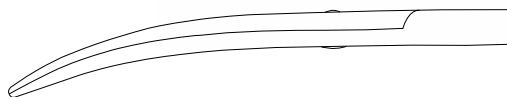

5472-23
METZENBAUM, TC

18 cm
gerade
straight
droit
recto

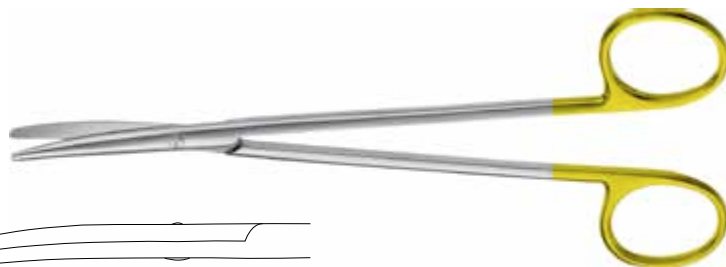

5473-03
METZENBAUM

18 cm
gebogen
curved
courbe
curvo

5473-23
METZENBAUM, TC

18 cm
gebogen
curved
courbe
curvo



5473-13
METZENBAUM

18 cm
gebogen
curved
courbe
curvo

Für Linkshänder
For left-handers
Pour gauchers
Para zurdos

nicht abgebildet, not illustrated, sans illustration, no ilustrado

5556-05
SCHUKNECHT
10 cm
gerade
straight
droit
recto



5562-00
PERWITSCHKY
10 cm



5566-03
TOENNIS
18 cm
gerade
straight
droit
recto

5567-03
TOENNIS
18 cm
gebogen
curved
courbe
curvo

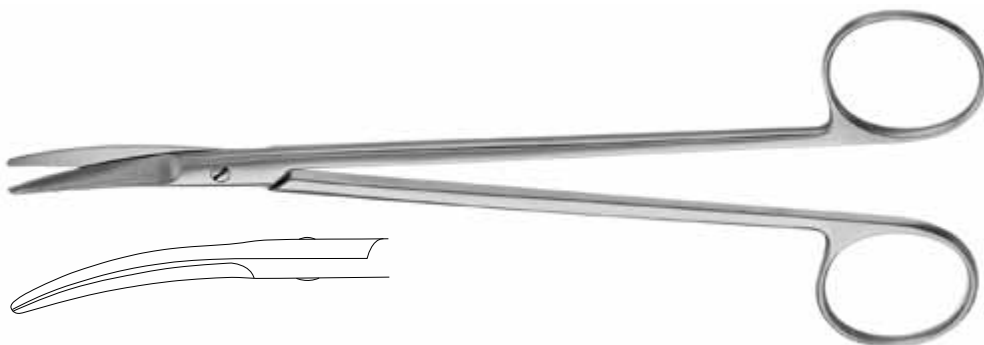

5577-03
POTTS-SMITH
19 cm
gebogen
curved
courbe
curvo

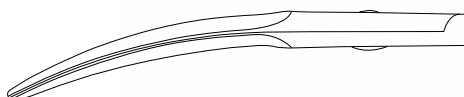
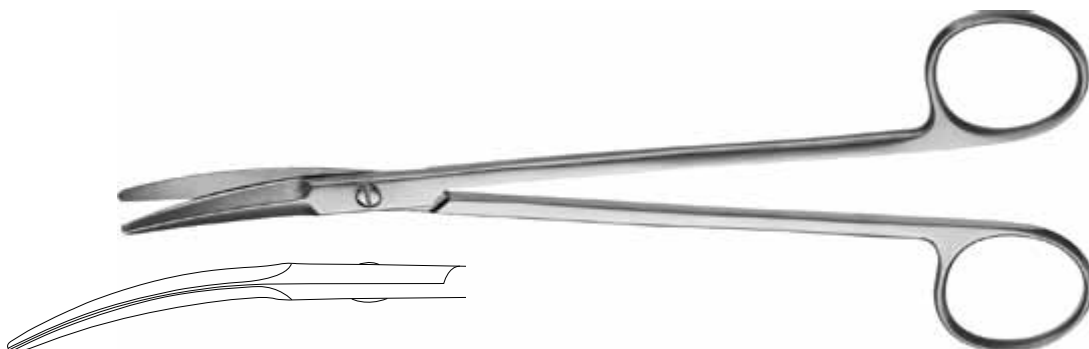



4610-03
REYNOLDS
11,5 cm
gerade
straight
droit
recto

4611-03
REYNOLDS
11,5 cm
gebogen
curved
courbe
curvo

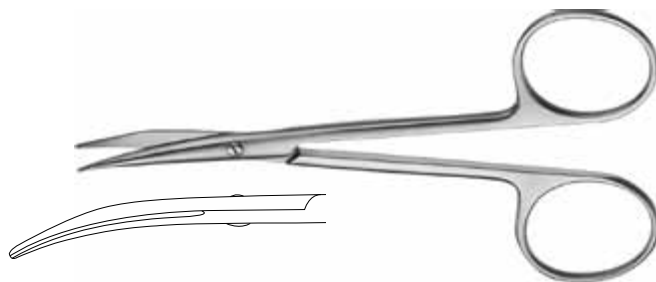

5583-03
REYNOLDS
13 cm
gebogen
curved
courbe
curvo

5583-23
REYNOLDS, TC
13 cm
gebogen
curved
courbe
curvo

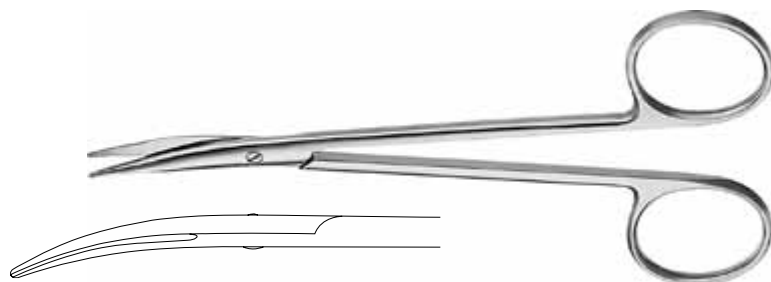

5580-03
REYNOLDS
15 cm
gerade
straight
droit
recto

5581-03
REYNOLDS
15 cm
gebogen
curved
courbe
curvo

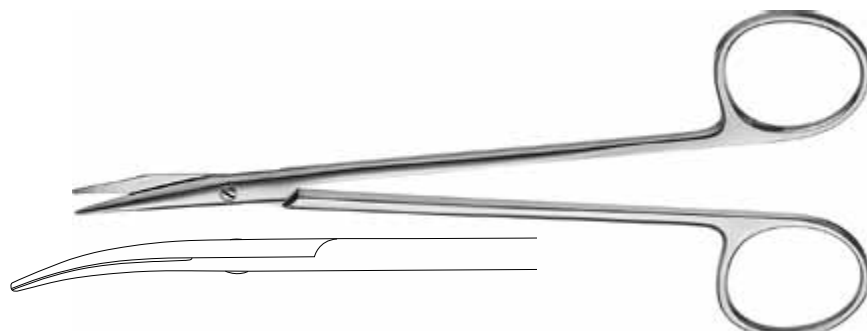

5585-03
REYNOLDS
18 cm
gebogen
curved
courbe
curvo

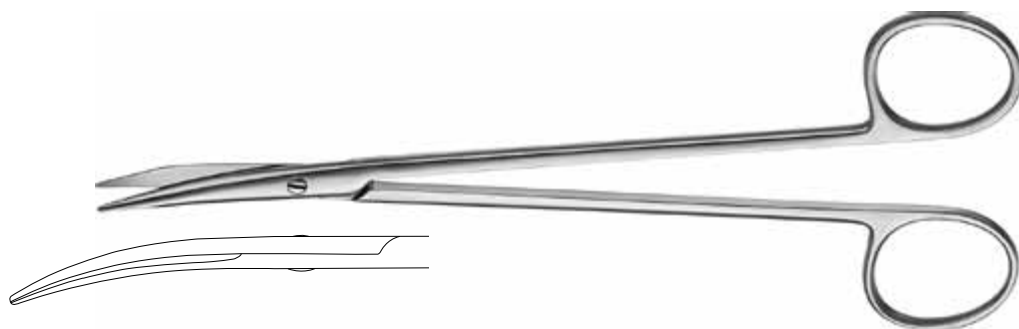

5587-03
REYNOLDS
20 cm
gebogen
curved
courbe
curvo

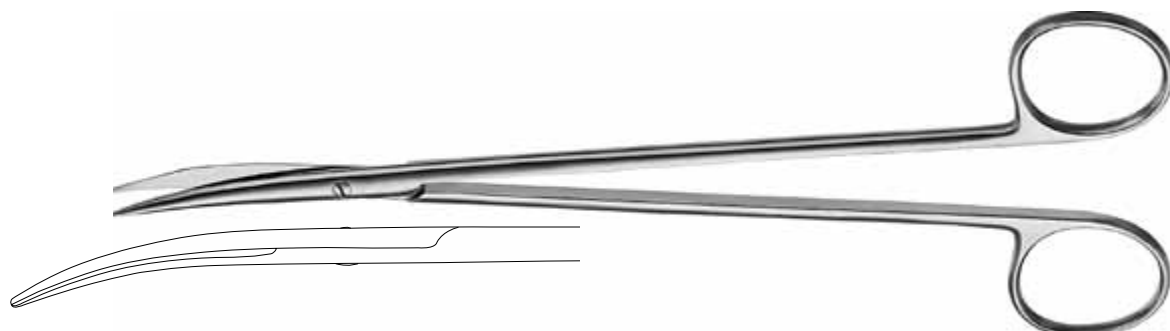

5523-03
COOLEY

19 cm
gebogen
curved
courbe
curvo

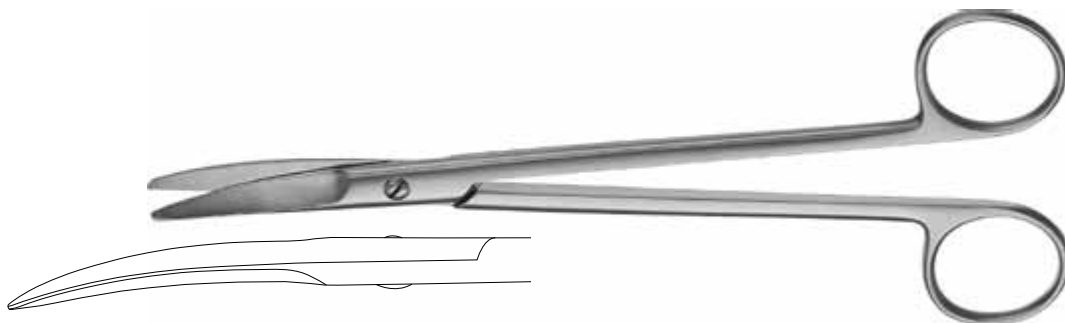

5559-71
RHOTON

18 cm
60°

kniegebogen
angled to side
coudé
angulado



5582-01
HEGEMANN

18 cm
25°

kniegebogen
angled to side
coudé
angulado



5584-01
HEGEMANN

17,8 cm
45°

kniegebogen
angled to side
coudé
angulado

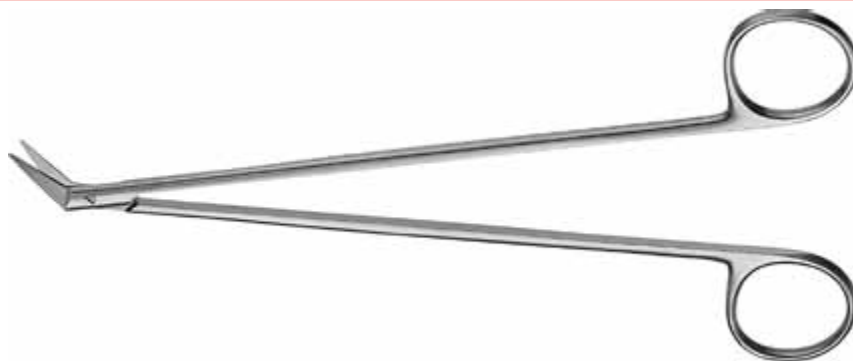

5586-01
HEGEMANN

17,5 cm
60°

kniegebogen
angled to side
coudé
angulado



GEFÄßSCHEREN
VASCULAR SCISSORS



CISEAUX VASCULAIRES
TIJERAS VASCULARES

5588-01
HEGEMANN
17 cm
90°

kniegebogen
angled to side
coudé
angulado



5589-01
HEGEMANN
17 cm
130°

kniegebogen
angled to side
coudé
angulado



5590-03
POTTS-SMITH
19 cm
25°

kniegebogen
angled to side
coudé
angulado

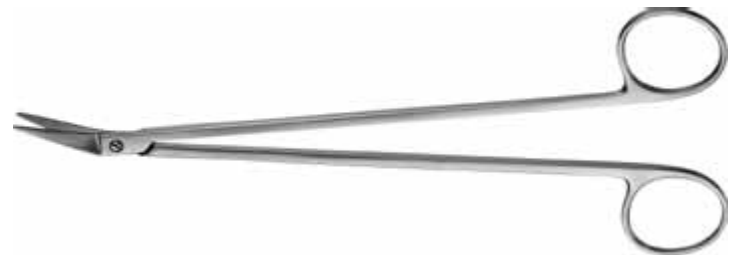

5594-03
POTTS-SMITH
18 cm
45°

kniegebogen
angled to side
coudé
angulado



5596-03
POTTS-SMITH
18 cm
60°

kniegebogen
angled to side
coudé
angulado



5664-01
KELLY

16 cm
gerade
straight
droit
recto

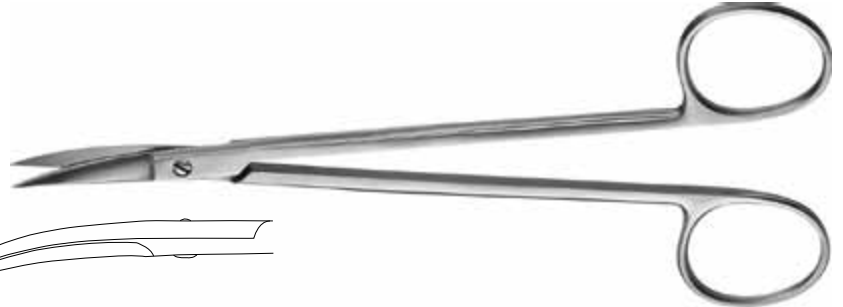

5665-01
KELLY

16 cm
gebogen
curved
courbe
curvo



5668-01
HAMBURGER MODELL

17 cm
gerade
straight
droit
recto

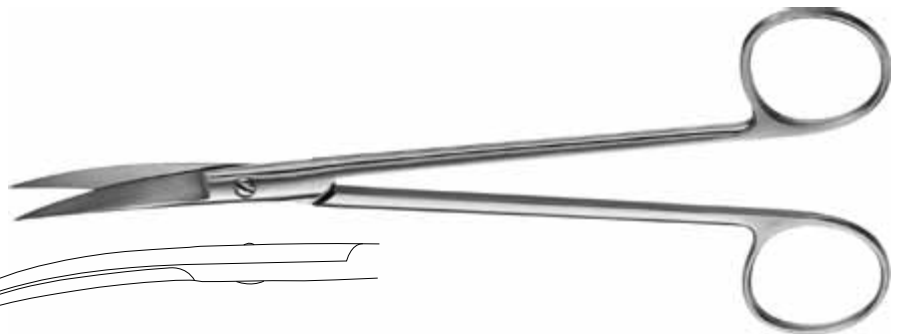

5669-01
HAMBURGER MODELL

17 cm
gebogen
curved
courbe
curvo

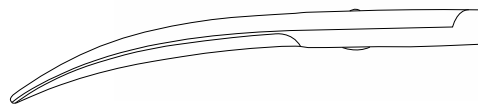

5680-00
WALDMANN

18 cm



MAYOSCHEREN
MAYO SCISSORS



CISEAUX MAYO
TIJERAS MAYO

5734-03
MAYO
14,5 cm
gerade
straight
droit
recto

5734D03
MAYO, Supercut
14,5 cm
gerade
straight
droit
recto

5735-03
MAYO
14,5 cm
gebogen
curved
courbe
curvo

5735D03
MAYO, Supercut
14,5 cm
gebogen
curved
courbe
curvo

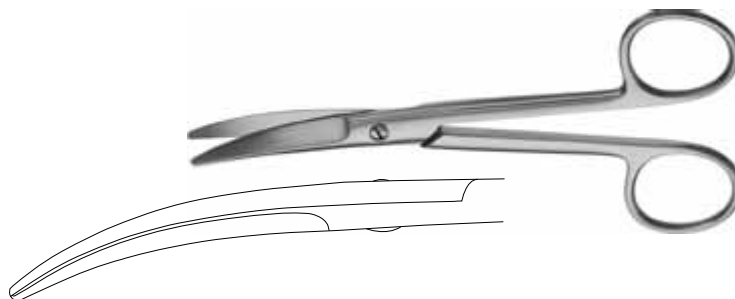

5738-03
MAYO
17 cm
gerade
straight
droit
recto

5738-13
MAYO
17 cm
gerade, für Linkshänder
straight, for left-handers
droit, pour gauchers
recto, para zurdos

5739-03
MAYO
17 cm
gebogen
curved
courbe
curvo

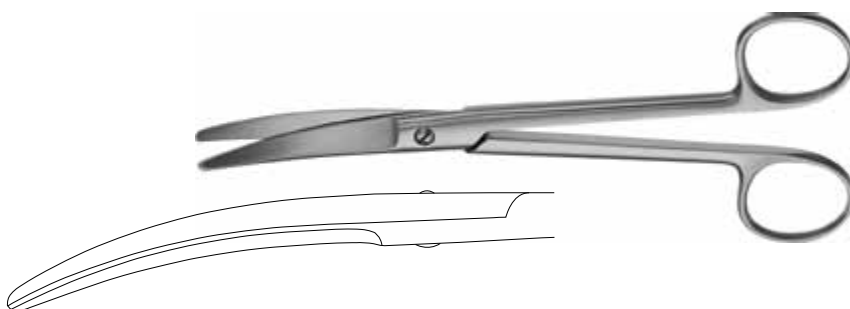

5759-03
MAYO-LEXER
21 cm
gebogen
curved
courbe
curvo

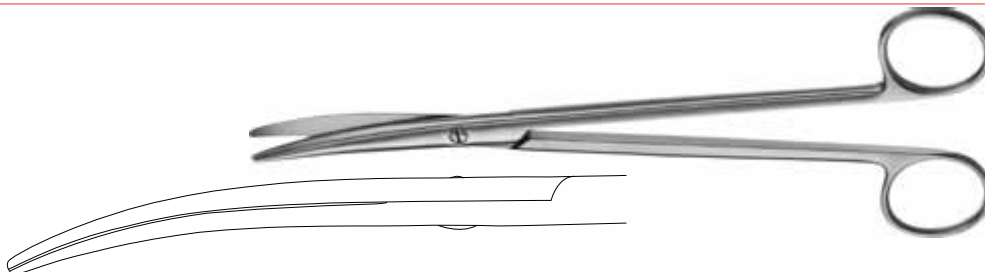

5762-03
MAYO-STILLE
15 cm
gerade
straight
droit
recto

5762-23
MAYO-STILLE, TC
15 cm
gerade
straight
droit
recto

5763-03
MAYO-STILLE
15 cm
gebogen
curved
courbe
curvo

5763-23
MAYO-STILLE, TC
15 cm
gebogen
curved
courbe
curvo

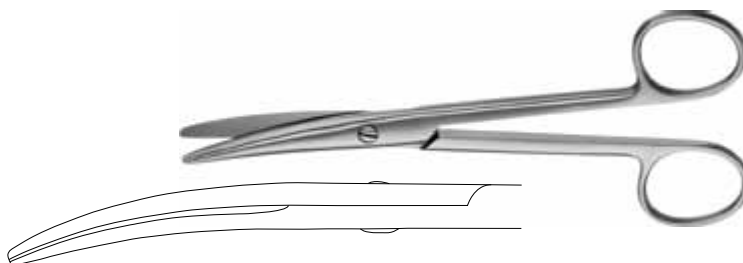

5764-03
MAYO-STILLE
17 cm
gerade
straight
droit
recto

5764-23
MAYO-STILLE, TC
17 cm
gerade
straight
droit
recto

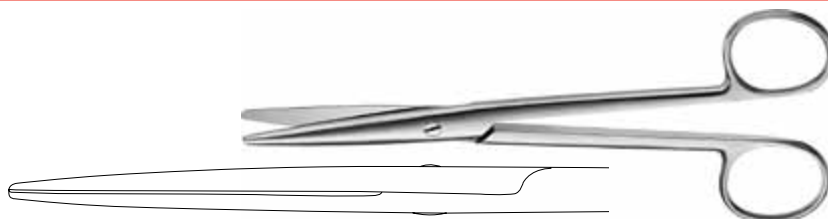

CHIRURGISCHE SCHEREN
OPERATING SCISSORS



CISEAUX À CHIRURGIE
TIJERAS PARA CIRUGÍA



5814-01 **5814-02** **5814-03**

14,5 cm
gerade
straight
droit
recto



5815-01 **5815-02** **5815-03**

14,5 cm
gebogen
curved
courbe
curvo

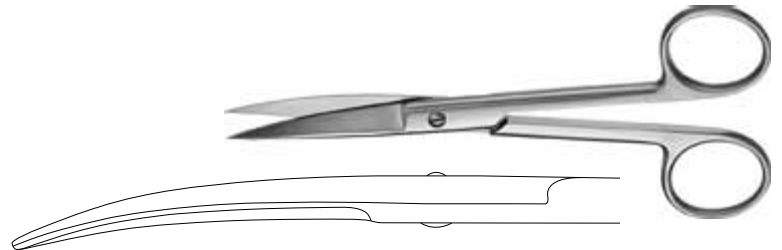

4604-03
STEVENS
11 cm
gerade, stumpf/stumpf
straight, blunt tips
droit, mousse
recto, romo

4605-03
STEVENS
11 cm
gebogen, stumpf/stumpf
curved, blunt tips
courbe, mousse
curvo, romo

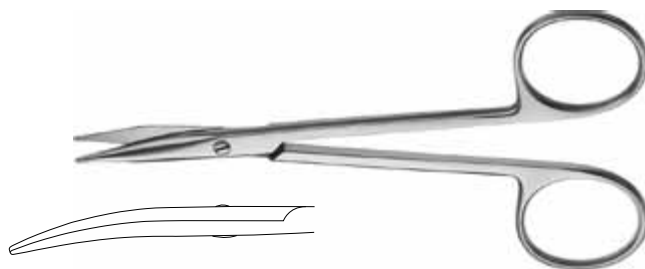

4708D01
SUPERCUT
10,5 cm
gerade, spitz/spitz
straight, sharp tips
droit, pointu
recto, agudo

4709D01
SUPERCUT
10,5 cm
gebogen, spitz/spitz
curved, sharp tips
courbe, pointu
curvo, agudo

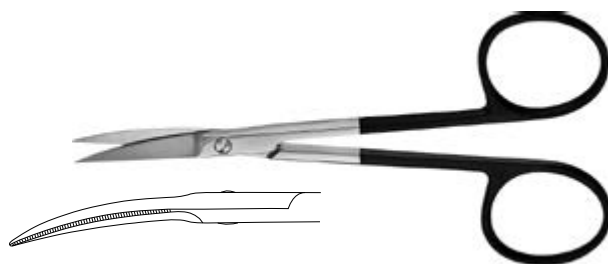

4754-01
11 cm
gerade
straight
droit
recto

4754-21
11 cm, TC
gerade
straight
droit
recto

4755-01
11 cm
gebogen
curved
courbe
curvo

4755-21
11 cm, TC
gebogen
curved
courbe
curvo

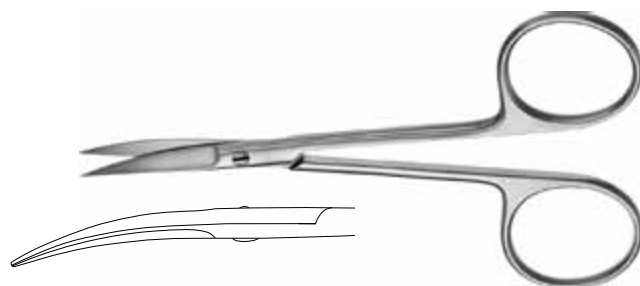

4762-01
10 cm
gerade
straight
droit
recto

4763-01
10 cm
gebogen
curved
courbe
curvo

mit extra großen Ringen
with special large rings
anneaux extrêmement grands
argollas muy grande

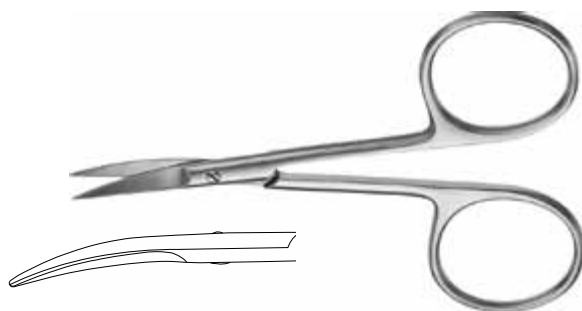

5340-01
JOSEPH
14,5 cm
gerade, spitz/spitz
straight, sharp tips
droit, pointu
recto, agudo

5341-01
JOSEPH
14,5 cm
gebogen, spitz/spitz
curved, sharp tips
courbe, pointu
curvo, agudo

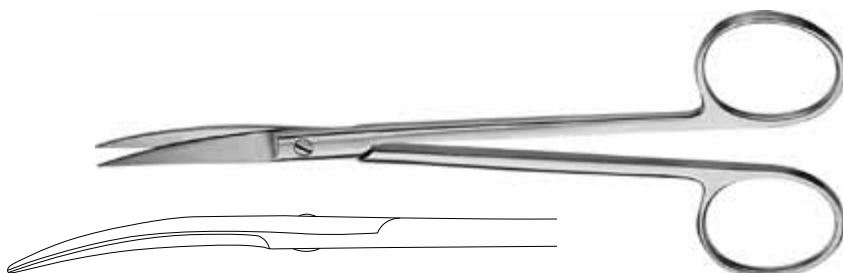

5342-01
PECK-JOSEPH
14,5 cm
gerade, spitz/spitz
straight, sharp tips
droit, pointu
recto, agudo

5343-01
PECK-JOSEPH
14,5 cm
gebogen, spitz/spitz
curved, sharp tips
courbe, pointu
curvo, agudo

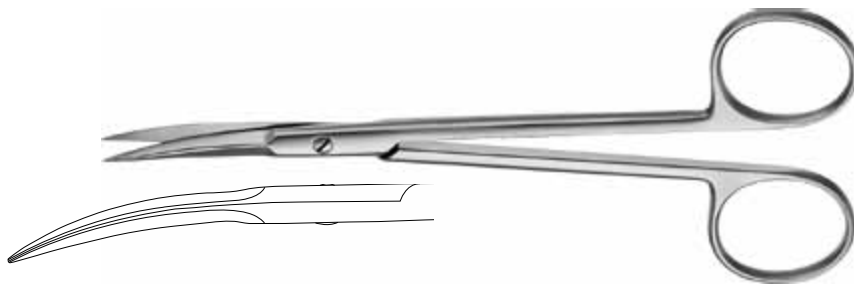

5342-03
PECK-JOSEPH
14,5 cm
gerade, stumpf/stumpf
straight, blunt tips
droit, mousse
recto, romo

5343-03
PECK-JOSEPH
14,5 cm
gebogen, stumpf/stumpf
curved, blunt tips
courbe, mousse
curvo, romo

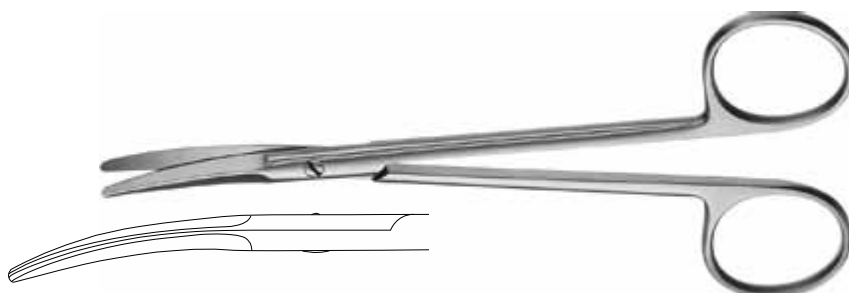

5576-03
GORNEY FACE LIFT
19 cm
gerade
straight
droit
recto

5577-03
KAYE FACE LIFT
19 cm
gebogen
curved
courbe
curvo

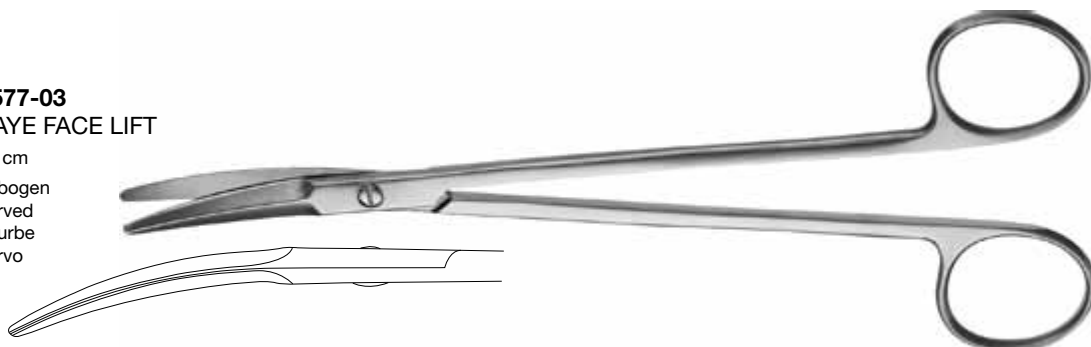

5580-03
REYNOLDS
15 cm
gerade
straight
droit
recto

5581-03
REYNOLDS
15 cm
gebogen
curved
courbe
curvo

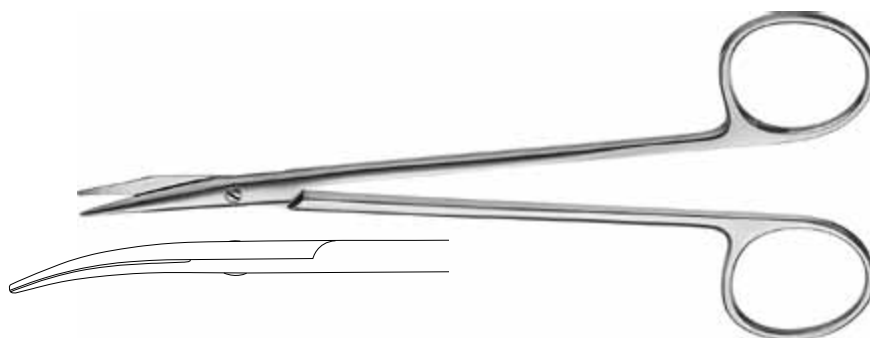

5583-03
REYNOLDS
13 cm
gebogen
curved
courbe
curvo

5583-23
REYNOLDS, TC
13 cm
gebogen
curved
courbe
curvo

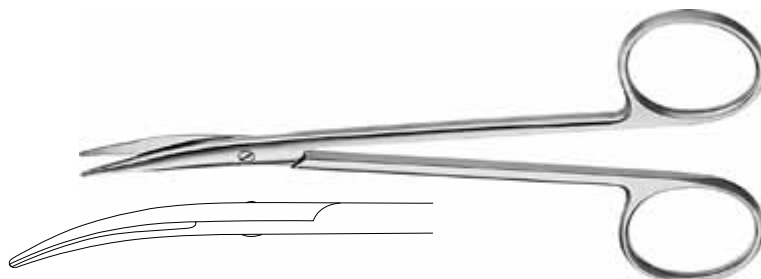

5931D03
STEVENS, Supercut
13,5 cm
gebogen, stumpf/stumpf
curved, blunt tips
courbe, mousse
curvo, romo

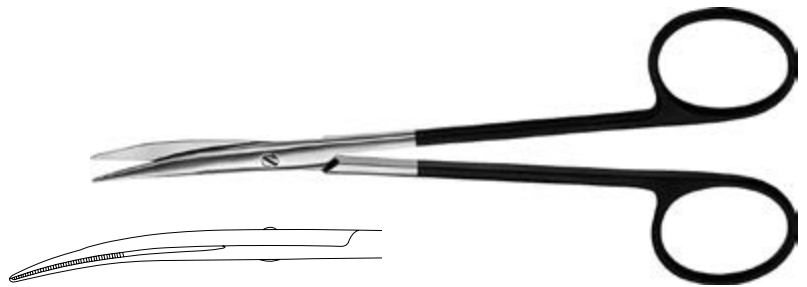

5933-03
METZENBAUM-LIPSET
14 cm
gebogen, stumpf/stumpf
curved, blunt tips
courbe, mousse
curvo, romo

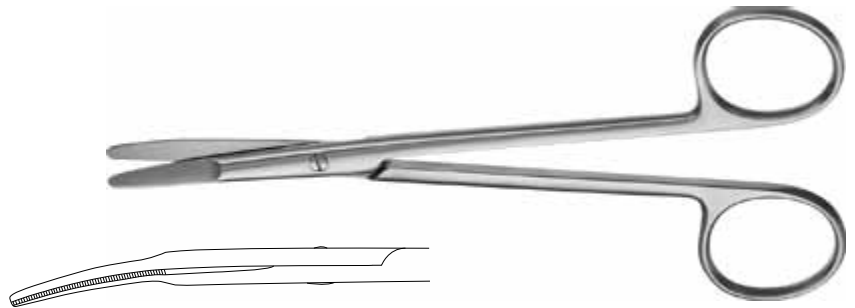

5937-03
FREEMAN/KILNER
17,5 cm
gebogen, stumpf/stumpf
curved, blunt tips
courbe, mousse
curvo, romo

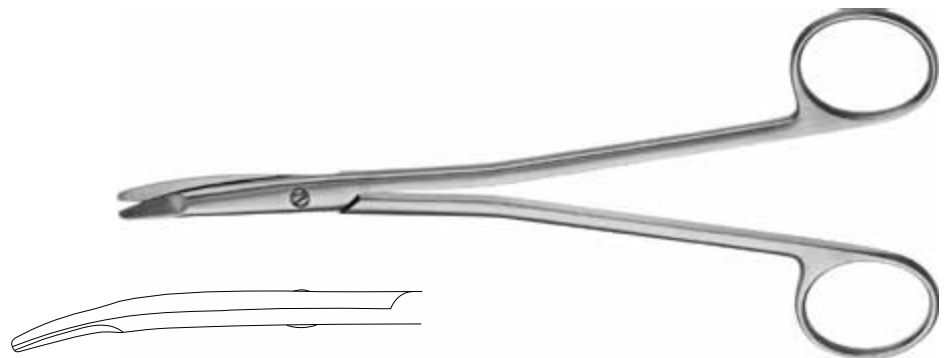

5939-03
REYNOLDS, fino
15 cm
gebogen, stumpf/stumpf
curved, blunt tips
courbe, mousse
curvo, romo

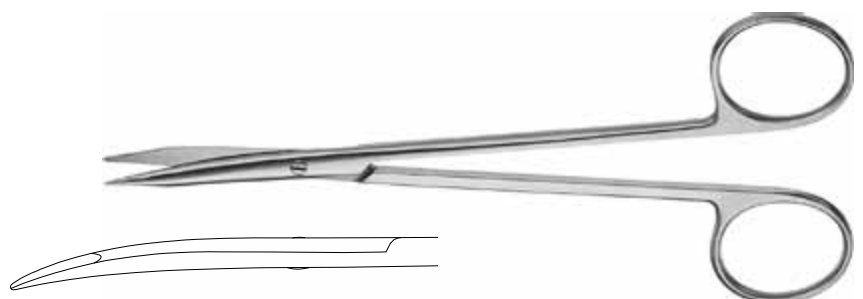

5943-23
KAYE FACE LIFT, TC
11,5 cm

5945-23
KAYE FACE LIFT, TC
14,5 cm

gebogen, stumpf/stumpf
curved, blunt tips
courbe, mousse
curvo, romo

5947-23
KAYE FACE LIFT, TC
18 cm

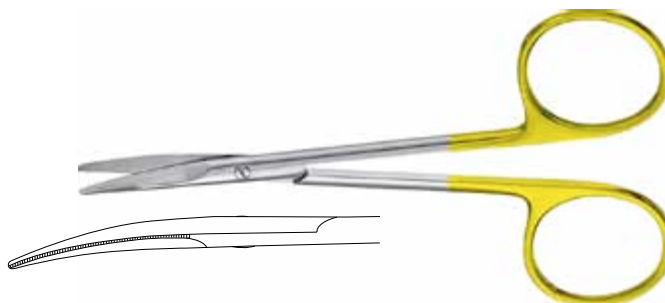

5959-03
KILNER
12 cm
gebogen, stumpf/stumpf
curved, blunt tips
courbe, mousse
curvo, romo

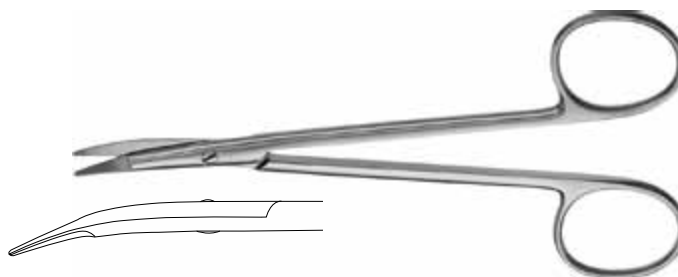

5961-03
13 cm
gebogen, stumpf/stumpf
curved, blunt tips
courbe, mousse
curvo, romo

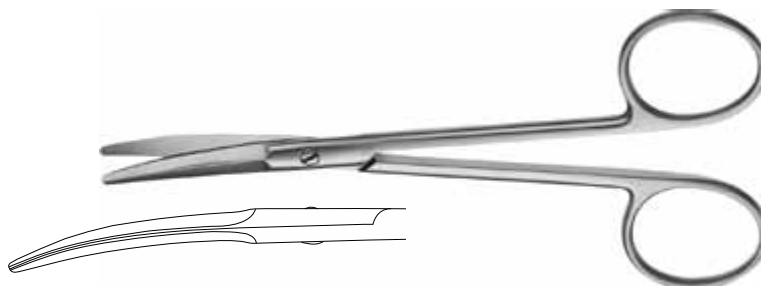

5963-03
ASTON FACE LIFT
16,5 cm
gebogen, stumpf/stumpf
curved, blunt tips
courbe, mousse
curvo, romo

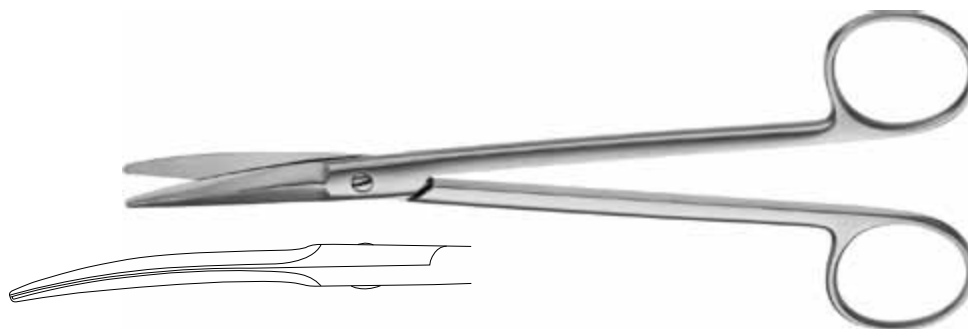

5965-03
FACE LIFT
20 cm
gebogen, stumpf/stumpf
curved, blunt tips
courbe, mousse
curvo, romo

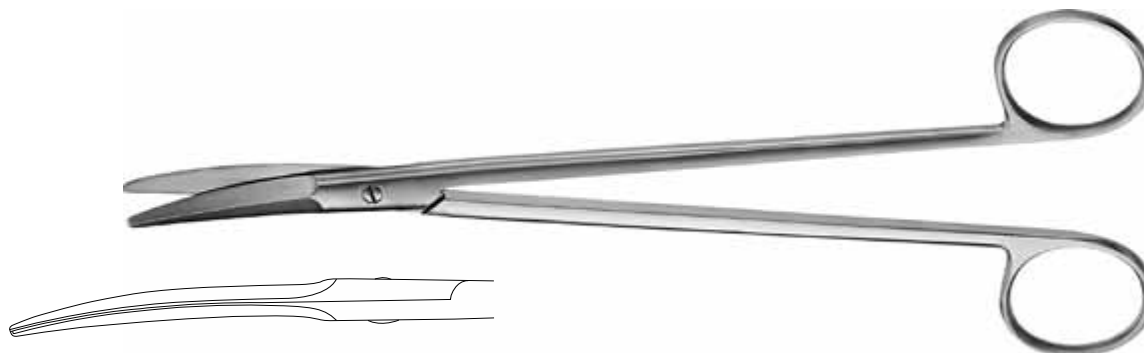

FADENSCHEREN
STITCH SCISSORS



CISEAUX POUR INCISION
TIJERAS PARA INCISIÓN

4840-00
SPENCER
9 cm



4842-00
SPENCER
11 cm



4847-01
10 cm
gebogen
curved
courbe
curvo

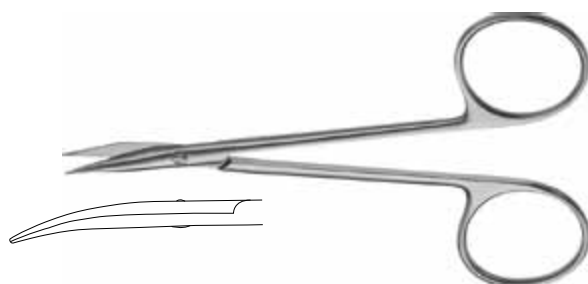

VERBANDSCHEREN
BANDAGE SCISSORS



CISEAUX À PANSEMENTS
TIJERAS PARA VENDAJES

5906-00
LISTER
18 cm



5908-00
LISTER
20 cm





	Seite		Seite		Seite
A					
ADSON, Irispinzetten	24.01	Hornhautscheren	43. – 44.	Fadenscheren	48.03
AEBLI, Augenscheren	48.01	Kapselpinzette	25.01	Fadenscheren	59.05
AGRICOLA, Wundsperrer	15.10	Klingenthaler	35.01	Federscheren für Micro-Chirurgie	42.
ALFONSO, Sperrelevator	15.10	Markierinstrumente	23.02	FENZL, Häkchen	17.04
Alpha-Chymotrypsin Kanüle	36.01	Nadelhalter	27.02 + 27.05	FINE-THORNTON, Fixierringe	23.04
ALVIS, Fremdkörperinstrument	20.01	Nahtpinzetten	26.03	Fistelscheren	56.01
Anatomische Pinzetten	24.01	Spateln	19.05 + 20.02	Fixationsringe	23.04
ANEL, Kanülen	36.01	Sperrelevatoren	15.03	Fixierpinzetten	25.03
ARLT, Schlinge	21.02	Synechiaschere	44.01	FLIERINGA, Fixationsringe	23.04
ARRUGA, Häkchen	17.03	Trephinen	23.01	FOMON,	
Kapselpinzetten	25.01	Zirkel	23.02	Nasenscheren	53.02 + 53.03 + 53.06
Nadelhalter	27.01	CASTROVIEJO-KALT, Nadelhalter	27.01	Plastikscheren	53.04 + 53.05
ARRUGA-NIZETIC, Kapselpinzette	25.01	CASTROVIEJO-SCHACHAR		FRANKFURTER MODELL, Spatel	19.04
Arterienklemmen	22.02	Markierinstrument	23.02	FREEMAN-KILNER,	
ASTON, Facelift Schere	59.04	CASTROVIEJO-VANNAS, Scheren	40.04	Schere für die plastische Chirurgie	59.03
ATKINSON, Retrobulbare Kanüle	36.02	CAUER, Chalazionspinzette	26.01	FREER, Elevator	19.02
AUBARET, Häkchen	17.01	Chalazionspinzetten	26.01	Fremdkörperinstrumente	20.01
Augenbrause	36.02	CHANG, Phako-Chopper	17.07	Fremdkörperpinzetten	26.02
Augenscheren	47. – 48.	Chirurgische Pinzetten	24.01	FUKASAKU, Häkchen	17.07
AXENFELD, Häkchen	17.01	Chirurgische Scheren	58.01		
Löffel	21.01	Chirurgische Spezialscheren	55.01 + 55.02	G	
AYER, Chalazionspinzette	26.01	Cilienpinzetten	26.02	GASS, Häkchen	17.03
		CITELLI, Stanze	22.04	Stanze	22.03
B		CLARK, Sperrelevator	15.05	Gefäßklemmen	22.01
BACKHAUS, Tuchklemme	22.02	CLAYMAN, Häkchen	17.02 + 17.03	Gefäßscheren	55.01 – 55.04
BAIRD, Chalazionspinzette	26.01	IOL-Pinzette	24.07	Gehirnscheren	55.01
BANGERTER, Muskelklemme	25.08	Linsenrotierer	17.06	GIESSEN, Dilatator	22.01
Sondenkanülen	36.03	COLIBRI, Nahtpinzetten	26.04 + 26.05	Spatel	19.04
Spateln	19.05	Nahtpinzetten	26.05	GILL, Kapselschere	40.05
Sperrelevatoren	15.06	CONWAY, Lidhalter	16.01	Glaskörperscheren	49.01
BARRAQUER, Cilienpinzetten	26.02	COOK, Sperrelevatoren	15.08	GOOD, Tonsillenschere	53.06
Fadenlöspinzette	26.06	COOLEY, Cardiovascularschere	55.03	GOOD-SCHWECKENDIECK,	
Federscheren für Mikrochirurgie	42.02	COTTLE BULLDOG, Nasenschere,		Tonsillenscheren	53.06
Fixierpinzette	25.03	Plastikschere	53.03	GORNEY, Facelift Scheren	59.02
Iridektomiescheren	40.02	COTTLE, Nasenscheren	53.02	GRADLE, Cilienpinzette	26.02
Klingenthaler	35.01	CRANZ, Augenbrause	36.02	GRAEFE, Augenscheren	47.04
Nadelhalter	27.	Cyclodialyse-Kanülen	36.02	Fixierpinzetten	25.04
Sperrelevatoren	15.06 + 15.07	D		Häkchen	17.01 + 17.02
Vorderkammerpinzetten	26.03	DARDENNE, Häkchen	17.03	Hockeymesser	18.01
BARRAQUER - MODELL FRANZ,		Satomesser	18.02	Kystotome	19.04
Hornhautscheren	44.01	DAVIEL, Löffel	21.01	Sperrelevator	15.03
BARRAQUER-OOSTERHUIS,		DEAN, Tonsillenschere	53.06	Starmesser	18.02
Sperrelevatoren	15.07	DERMOT-PIERSE, Micro-Pinzette	24.02	GRAETHER,	
BECHERT, Linsenrotierer	17.06	DESMARRES, Chalazionspinzetten	26.01	Kragenknopf Kapselpolierer	17.06
BECHERT-McPHERSON,		Lidhalter	16.01	GRANDON, Saug- und Spülkanülen	36.05
Nahtpinzette	26.04	Diamant-Messer	18.01	GREEN, Doppelinstrument	20.02
BEER, Cilienpinzette	26.02	DIEFFENBACH, Gefäßklemmen	22.01	Fixierpinzette	25.03
BERKE, Entropionspinzette	25.06	Dilatatoren	22.01	Häkchen	17.02
BEYER, Stanze	22.04	Diszissionsnadeln und -messer	19.02	GUTHRIE, Häkchen	17.01
BISHOP-HARMON, Irispinzette	24.04	DODEN, IOL-Pinzette	24.07	Gynäkologische Scheren	56.01
Kanüle mit Silicon-Ball	36.06	Doppelinstrumente	20.02		
BLASCOVIC, Muskelpinzetten	25.06	DRAEGER, Bindehautpinzette	25.02	H	
BOETTCHER, Tonsillenscheren	53.06	DRYSDALE, Kernmanipulator	17.07	Häkchen	17.
BONACCOLTO,		E		HAEFELIGER,	
Pinzetten f. Schieloperationen	25.04	Elevatorium	19.02	Micro-Manipulator	17.08
BONNER MODELL, Augenscheren	47.02	ELSCHNIG,		HALSTED-MOSQUITO, Klemmen	22.02
Häkchen	17.01	Pinzette für Schieloperation	25.04	HAMBURGER MODELL,	
Mikropinzetten	24.02 + 24.03	Spatel	19.05	Fistelscheren	56.01
Strabismushaken	17.02	ELZE, Micro-Pinzette	24.02	Irispinzette	24.04
Spülkanüle	36.01	ENGLISCHES MODELL,		Luftlanze	18.03
BORES, Markierinstrumente	23.03	Nahtpinzetten	26.06	HARMS, Trabekular-Sonden	21.04
BOWMAN, Sonden	21.03	Entropionspinzetten	25.06	HARTMANN-MOSQUITO,	
BRAUWEILER, Kanüle	36.01	Enukleationsscheren	48.04	Klemmen	22.02
BUNGE, Löffel	21.01	Episiotomiescheren	56.01	Healon Injektionskanüle	36.01
BURATTO, IOL-Pinzetten	24.06 + 24.07	F		HEBRA, Löffel	21.01
C		Faceliftscheren	59.02 – 59.04	HEGEMANN,	
Cardiovascularscheren	55.03 + 55.04	Fadenlöspinzette	26.06	Cardiovascularscheren	55.03 + 55.04
CASTROVIEJO,		Fadenlösmesser	19.02	HEIDELBERGER MODELL,	
Dilatator	22.01			Cilienpinzette	26.02
Fixierpinzetten	25.02			Elevatorium	19.02
CASTROVIEJO,				Irispinzette	24.04
				Rasparatorium	19.02



Seite		Seite		Seite
	HEIDELBERGER MODELL, Strabismusschere	46.02		
	HEIMANN, Glaskörperscheren	49.01		
	HELVESTON, Häkchen	17.03		
	HENRY, Cilienpinzette	26.02		
	HESLIN, Infusionskanüle	36.04		
	HESS, Irispinzette	24.04		
	HESS, Kapselpinzette	25.01		
	HEYMANN, Nasenscheren	53.01 + 53.03		
	HOFFER, Markierinstrumente	23.03		
	HOFFER-STERN, Kapselschere	40.05		
	HOLTH, Stanze	22.03		
	Hornhautscheren	43. – 44.		
	HUNT, Chalazionspinzette	26.01		
I				
	Infusionskanüle	36.04		
	IOL-Häkchen	17.04 – 17.08		
	IOL-Pinzetten	24.06 + 24.07		
	Iridektomiescheren	40.		
	Irishäkchen	17.01 + 17.04		
	Irismesser	19.03		
	Irispinzetten	24.01 – 24.04		
J				
	JACOBI, Repositionshäkchen	17.07		
	JÄCKER, Fadenlösmesser	19.02		
	JAEGER, Häkchen	17.02		
	Lanzenmesser	18.03		
	Lidplatte	16.01		
	JAFFE, Lidhalter	16.01		
	Spatel	17.04		
	JAFFE-KNOLLE, Irishäkchen	17.04		
	JAMESON, Häkchen	17.02		
	Muskelpinzetten	25.05		
	JENSEN, Kapselpolierer	36.05		
	JESS, Fixierpinzette	25.02		
	JEWELER, Fremdkörperpinzette	26.02		
	JONES, Tuchklemme	22.02		
	JOSEPH, Nasenscheren	53.03		
	Plastikschere	59.01		
K				
	KAGAWA, Phaco Chopper	17.04		
	KALT, Nadelhalter	27.01		
	KANSAS, Handgriff	36.06		
	Kanülen	36.		
	Kanülenbänkchen	37.01		
	Kapselpinzetten	25.01		
	Kapselpolierer	17.06 + 36.05		
	Kapselscheren	40.05		
	Kapselstanzen	22.03		
	Kapsulorhexis-Pinzetten	24.05		
	KATZIN, Hornhautscheren	43.02		
	Kauter	19.03		
	KAYE, Facelift Scheren	59.02 + 59.04		
	KELLY, Fistelscheren	56.01		
	Stanze	22.03		
	KELMAN, Pinzetten	24.07		
	Keratoplastiksiebpatel	19.04		
	Kernmanipulator	17.07 + 17.08		
	Kernspalter	17.05		
	KERRISON, Stanzen	22.04		
	KILNER, Plastikschere	53.05 + 59.04		
	KIMURA, Platinspatel	19.04		
	Klemmen	22.02		
	Klingen	35.02		
	Klingenhalter	35.01		
	KNAPP, Irismesser	19.03		
	KNIGHT, Nasenscheren	53.01		
	KNOLLE, Irishäkchen	17.04		
	Kapselpolierer	36.05		
	Linsenschlinge	36.05		
	KNOLLE-PEARCE, Vorderkammer-Spülkanüle	36.05		
	KOCH, Mikro-Schere	42.01		
	Nucleus Spateln	19.05		
	Phako-Chopper	19.01		
	Phako-Splitter	17.06		
	Kombideller	19.04		
	Kortex-Extraktor	36.04		
	KRAFF-UTRATA, Kapsulorhexis-Pinzetten	24.05		
	KRATZ, Kapselpolierer	36.05		
	KRATZ-BARRAQUER, Sperrelevatoren	15.09		
	KREISSIG, Kombideller	19.04		
	KREMER, Hornhautfixierpinzette	25.03		
	KUGLEN, Linsen-Manipulator	17.03 + 17.04		
	KUHNT, Schaber	19.02		
L				
	LAGRANGE, Augenschere	47.05		
	LAMBERT, Chalazionspinzette	26.01		
	LANCASTER, Sperrelevator	15.02		
	Lanzenmesser	18.03		
	LESTER, Irispinzette	24.04		
	Lidhalter	16.01		
	Lidklemme	16.01		
	Lidsperrerr	15.		
	LIEBERMAN, Micro Finger Sperrelevatoren	17.07 15.01		
	Ligateurscheren	59.05		
	Linsen-Manipulatoren	17.04 – 17.08		
	Linsenimplantationspinzetten	24.06 + 24.07		
	Linsenspatel	17.04 + 17.07		
	Linsenrotierer	17.04 – 17.08		
	Linsenschlingen mit Spülung	36.05		
	LISTER, Verbandscheren	59.06		
	LIVERNOIS, IOL-Pinzette	24.06		
	Löffel	21.01		
	LORDAN, Chalazionspinzette	26.01		
	Luftkanülen	36.01		
	Luftlanze	18.03		
	Lungenscheren	54.01 + 54.02		
M				
	MACKENSEN, Sonden Keratoplastikschere	21.04 44.02		
	Magnet	20.01		
	Markierinstrumente	23.02 + 23.03		
	MASKET, Kapsulorhexispinzette	24.05		
	Maßstab	23.02		
	MAUMENEE-PARK, Sperrelevator	15.05		
	MAYO, Scheren	57.01		
	MAYO-LEXER, Operationsscheren	57.01		
	MAYO-STILLE, Operationsscheren	57.01		
	McCULLOUGH, Pinzetten für Schieloperation	25.04		
	McDONALD, IOL-Pinzette	24.06		
	McGUIRE, Augenscheren	48.02		
	Federscheren für Mikrochirurgie	42.02		
	McINTYRE, Kanülen Sperrelevatoren	36.03 15.10		
	McPHERSON, IOL-Pinzette	24.07		
	Micropinzetten	24.02		
	Meißel	19.03		
	MELLINGER, Sperrelevator	15.02		
	MELLINGER-BEARD, Sperrelevator	15.02		
	Messblock	23.04		
	Messinstrumente	23.02		
	Messlehren	23.04		
	METZENBAUM, fino, leichtes Modell	54.01		
	METZENBAUM, Scheren	54.01 + 54.02		
	METZENBAUM, Tonsillenscheren	53.07		
	METZENBAUM-LIPSET, Präparierschere	59.03		
	MEYER, Meißel	20.01		
	MEYER-SCHWICKERATH, Lokalisator	23.02		
	MEYHÖFER, Löffel	21.01		
	Micro-Klingenhalter	35.01		
	Micro-Lidsperrerr	15.		
	Micro-Nadelhalter	27.03 – 27.05		
	Micro-Pinzetten	24.02 + 24.03		
	Micro-Spateln	17.04 + 19.05		
	MOORFIELD, Nahtpinzette	26.04		
	Mosquitoklemmen	22.02		
	MUCK, Tonsillenschere	53.06		
	MUELLER, Wundsperrerr	15.10		
	MULDOON, Dilatator	22.01		
	MURDOCK, Sperrelevator	15.05		
	Muskelklemme	25.06		
	Muskelpinzetten	25.05		
N				
	Nadelhalter	27.		
	NAGAHARA, Hydro Chopper	19.01		
	Linsenspatel	17.07		
	Nucleus Chopper	17.08		
	Nahtpinzetten	26.03 – 26.06		
	Nasenscheren	53.00 – 53.05		
	Nasenrachenscheren	53.00 – 53.05		
	NETTLESHIP, Dilatatoren	22.01		
	NEUHANN, Fixierring	23.04		
	Häkchen	17.05		
	Kernspalter	17.05		
	NEUMANN-SHEPARD, Markierinstrumente	23.03		
	Noppenmatte	37.02		
	Noppenstreifen	37.02		
	NOYES, Iridektomiescheren	40.01		
	Nucleus Chopper	17.08		
O				
	Ohrenschere	55.01		
	ONG, Kapselschere	40.05		
	Operationsscheren	58.01		
	OSHER-NEUMANN, Markierinstrumente	23.03		
P				
	PARK-GUYTON, Sperrelevator	15.06		
	PATON, Hockeymesser	18.01		
	PAUFIQUE, Nahtpinzette	26.04		
	PECK-JOSEPH, Plastikscheren	53.04 + 59.02		
	PERWITSCHKY, Operationsschere	55.01		
	Phako-Chopper	17.01 – 19.01		
	Phako-Lanzen	18.03		
	Phako-Splitter	17.06		
	Pigtail Sonden	21.04		
	Pinzetten	24. – 26.		
	Pinzetten für Mikro-Chirurgie	24.02 + 24.03		
	Pinzetten für Schieloperation	25.04		
	PISACANO, Kernmanipulator	17.08		
	PLANGE, Fremdkörperhebel	20.01 + 20.02		
	Platinspatel	19.04		
	Plastikscheren	59.01 – 59.04		
	POTTS-SMITH, Cardiovascularscheren	55.04		
	Präparierschere	55.01		
	Präparierscheren	54.01 + 54.02		
	PRINCE, Muskelpinzetten	25.05		



	Seite		Seite		Seite
R				Z	
RAININ, Luftkanüle	36.01	STEVENSON, Wundsperrer	15.10	ZIEGLER, Irismesser	19.03
RANDOLPH, Cyclodialysekanüle	36.02	Strabismushaken	17.02	Zirkel	23.02
Rasierklingen	35.02	Strabismuspinzetten	25.04	Zügelnahtpinzette	25.03
Rasparatorium	19.02	Strabismusscheren	46.	ZUERCHER MODELL, Nahtpinzetten	26.05
REMKY, Micro-Pinzette	24.02	Super Cut Scheren	50.00		
Zügelnahtpinzette	25.03	Synechiaschere	44.02		
Repositionshäkchen	17.07				
Retrobulbäre Kanüle	36.02	T			
REYNOLDS fino, Präparierschere	59.03	TENNANT, Lidhalter	16.01		
REYNOLDS, Gefäßscheren	55.02 + 59.02	THORNTON, Fixationsring	23.04		
REYNOLDS, Präparierscheren	59.02	TOENNIS, Gehirnscheren	55.01		
RHOTON, Mikroschere	55.03	Tonometer	29.01		
ROLLET, Häkchen	17.01	TOOKE, Messer	18.01		
Meißel	19.03	Tonsillenscheren	53.06 + 53.07		
ROSEN, Hydro-Chopper	19.01	Trabekular-Scheren	40.04		
Phako Chopper	19.01	Trabekular-Sonden	21.04		
Phako-Splitter	17.06	Tränenwegkanülen	36.		
RUBMAN-KATZIN, Kapselpolierer	36.05	Trephinen	23.01		
RUEDEMANN, Dilatator	22.01	TROUTMAN,			
		Alpha-Chymotrypsin Kanüle	36.01		
S		Hornhautscheren	43.01		
ST MARTIN, Nahtpinzette	26.04	Klingenthaler	35.01		
Satomesser	18.02	Spatel	19.05		
SATTLER, Muskelpinzetten	25.05	TÜBINGER MODELL,			
SAUER, Sperrelevatoren	15.03	Nahtpinzetten	26.03 + 26.04		
Saug- und Spülkanülen	36.	Vannas-Scheren	40.04		
SAUTTER, Luftkanüle	36.01	Tuchklemme	22.02		
Schaber	19.02	TYRELL, Häkchen	17.01		
SCHEPENS, Lidhalter	16.01				
Scheren	47. - 59.	U			
SCHIOETZ, Tonometer	29.01	URIBE-STERN, Kapselschere	40.05		
Schlingen	21.02 + 36.05	UTHOFF, Kapselschere	40.05		
SCHOTT, Sperrelevatoren	15.08	UTRATA,			
SCHUKNECHT, Drahtschere	55.01	Kapsulorhexis-Pinzetten	24.05		
SCHWEIZER MODELL,					
Cilienpinzette	26.02	V			
Fremdkörperradel	20.01	VANNAS, Scheren	40.03 + 40.04		
Kapselpinzette	25.01	Verbandscheren	59.06		
Trephinen	23.01	Vorderkammerpinzetten	26.03		
Sehnenscheren	45. - 46.	Vorlagerungspinzetten	25.05		
SHAAF, Fremdkörperpinzette	26.02				
SHEA, Neurochirurgische Schere	53.04	W			
SHEETS, Linsenschlinge	36.05	WADSWORTH-TODD, Kauter	19.03		
SHEPARD, IOL-Pinzette	24.07	WALDMANN, Episiotomieschere	56.01		
RK-Spülkanüle	36.02	WALSER, Stanze	22.03		
SHEPARD-KREMER, Meßblock	23.04	WALTER, Schere	47.04		
Silicon-Instrumenteneinsatz	37.01	WATZKE, Spreizpinzette	25.06		
Silicon-Noppenmatte	37.02	WEBER, Schlingen	21.02		
SIMCOE, Kortex-Extractor	36.03	WECKER, Iridektomiescheren	40.02		
SIMCOE,		Spatel	19.05		
Saug- und Spülkanülen	36.04	WEISS, Sperrelevatoren	15.02 + 15.04		
SINSKEY, Häkchen	17.03 + 17.04	WELLS, Löffel	21.01		
Skalpelle	18.01	WEST, Meißel	19.03		
Skalpellgriffe	35.02	Spülkanülen	36.03		
Sklerotome	18.01	WESTCOTT,			
SNELLEN, Entropionspinzetten	25.06	Federschere für Micro-Chirurgie	42.02		
Schlinge	21.02	Sehnenscheren	45.01		
Sonden	21.03 + 21.04	WHEELER, Diszissionsmesser	19.02		
Sondenkanülen	36.	Doppelinstrument	20.02		
Spateln	19.04 + 19.05	WILDER, Dilatatoren	22.01		
Spateln, IOL	17.04	WILLIAMS, Sperrelevatoren	15.09		
SPEEMANN, Fremdkörperpinzette	26.02	WILMER, Augenschere	47.04		
SPENCER,		WORST, Pigtail	21.04		
Fadenschere	48.03	WORTH, Muskelpinzetten	25.05		
Inzisionsschere	59.05	Wundhaken	17.01 + 17.02		
Sperrelevatoren	15.	Wundlöffel	21.01		
Spülkanülen	36.	Wundsperrer	15.10		
Stanzen	22.03 + 22.04				
Starmesser	18.02				
Sterilisierbehälter	37.01 + 37.04				
STEVENS, Häkchen	17.03				
Nadelhalter	27.01				
Sehnenscheren	46.01, 53.00, 59.03				



	Page		Page		Page
A				E	
ADSON, Iris forceps	24.01	Capsule forceps	25.01	Ear scissors	55.01
AEBL, Eye scissors	48.01	Capsule polishers	17.06 + 36.05	Elevator	19.02
AGRICOLA, Retractor	15.10	Capsule scissors	40.05	ELSCHNIG, Spatula	19.05
ALFONSO, Eye specula	15.10	Capsulorhexis forceps	24.05	Strabismus forceps	25.04
Air injection cannulas	36.	Cardiovascular scissors	55.03 + 55.04	ELZE, Micro-forceps	24.02
ALVIS, Foreign body instrument	20.01	CASTROVIEJO, Calipers	23.02	English model, Suture forceps	26.06
ANEL, Cannulas	36.01	Capsule forceps	25.01	Entropium forceps	25.06
ARLT, Loop	21.02	Corneal scissors	43. - 44.	Enucleation scissors	48.04
ARRUGA, Capsule forceps	25.01	Dilators	22.01	Episiotomy scissors	56.01
Hooks	17.03	Eye specula	15.03	Eye scissors	47. - 48.
Needleholders	27.01	Fixation forceps	25.02	Eye speculas	15.
ARRUGA-NIZETIC, Capsule forceps	25.01	Marking instruments	23.02		
ASTON, Face-lift scissors	59.04	Needle holders	27.02 + 27.05		
Artery scissors	55.01 - 55.04	Razor blade holder	35.01		
ATKINSON, Retrobulbar needle	36.02	Spatulas	19.05 + 20.02	F	
AUBARET, Hook	17.01	Suture forceps	26.03	Face-lift scissors	59.02 - 59.04
AXENFELD, Hooks	17.01	Synechia scissors	44.01	FENZL, Hook	17.04
Spoons	21.01	Trepines	23.01	FINE-THORNTON, Fixation ring	23.04
AYER, Chalazion forceps	26.01	Vannas-type scissors	40.04	Fistula scissors	56.01
		CASTROVIEJO-KALT.		Fixation forceps	25.03
		Needle holder	27.01	Fixation rings	23.04
		CASTROVIEJO-SCHACHAR		FLIERINGA, Fixation rings	23.04
		Marking instrument	23.02	FOMON,	
B		Cataract knives	18.02	Nasal scissors	53.02 + 53.03 + 53.06
BACKHAUS, Towel clamp	22.02	CAUER, Chalazion forceps	26.01	Plastic scissors	53.04 + 53.05
BAIRD, Chalazion forceps	26.01	Cautery	19.03	Forceps for micro-surgery	24.02 + 24.03
Bandage scissors	59.06	Chalazion forceps	26.01	Foreign body forceps	26.02
BANGERTER, Eye specula	15.06	CHANG, Phaco Chopper	17.07	Foreign body instruments	20.01
Muscle clamp	25.08	Chisels	19.03	FRANKFURTER MODELL, Spatula	19.04
Probe cannulas	36.03	Cilia forceps	26.02	FREER, Elevator	19.02
Spatulas	19.05	CITELLI, Punches	22.04	FREEMAN-KILNER,	
BARRAQUER, Capsule forceps	25.01	Clamps	22.02	Scissors for plastic surgery	59.03
Cilia forceps	26.02	CLARK, Eye speculum	15.05	FUKASAKU, Hook	17.07
Eye specula	15.06 + 15.07	CLAYMAN, IOL-forceps	24.07		
Fixation forceps	25.03	IOL-Hook	17.02 + 17.03		
Iris scissors	40.02	Lens nucleus rotator	17.06	G	
Needleholders	27.	COLIBRI, Suture forceps	26.04 + 26.05	GASS, Hook	17.03
Razor Blade holder	35.01	COLIBRI-TROUTMAN,		GIESSEN, Dilator	22.01
Secondary membrane forceps	26.03	Suture forceps	26.05	Spatula	19.04
Spring handle scissors		Conjunctival scissors	47.	GILL, Capsule scissors	40.05
for micro-surgery	42.02	CONWAY, Lid retractor	16.01	GILLS, Capsule scissors	40.05
Suture removal forceps	26.06	COOLEY, Cardiovascular scissors	55.03	GOOD, Tonsil scissors	53.06
BARRAQUER-MODELL FRANZ,		COTTLE BULLDOG,		GOOD-SCHWECKENDIECK,	
Corneal scissors	44.01	Nasal scissors,		Tonsil scissors	53.06
BARRAQUER-OOSTERHUIS		Plastic scissors	53.03	GORNEY, Face-lift scissors	59.02
Eye Specula	15.07	COTTLE, Nasal scissors	53.02	GRADLE, Cilia forceps	26.02
BECHERT, Lens nucleus rotator	17.06	COOK, Eye specula	15.08	GRAEFE, Cataract knives	18.02
BECHERT-MCPHERSON,		Corneal scarifiers	19.02	Cystotomes	19.04
Suture forceps	26.04	Corneal scissors	43. - 44.	Eye scissors	47.04
BEER, Cilia forceps	26.02	Cortex extractor	36.03	Eye speculum	15.03
BERKE, Entropium forceps	25.06	CRANZ, Irrigating cannula	36.02	Fixation forceps	25.04
BEYER, Punch	22.04	Cyclodialysis cannulas	36.	Hooks	17.01 + 17.02
BISHOP-HARMON,		Cystotomes	19.04	GRAETHER, Capsule polisher	17.06
Cannula with silicone bulb	36.06			GRANDON,	
Iris forceps	24.04	D		Irrigating-Aspirating cannulas	36.05
BLASCOVIC, Muscle forceps	25.06	DARDENNE, hook	17.03	GREEN, Double-ended instrument	20.02
BOETTCHER, Tonsil scissors	53.06	Sato knife	18.02	Fixation forceps	25.03
BONACCOLTO, Strabismus forceps	25.04	DAVIEL, Spoons	21.01	Hook	17.02
BONNER MODELL,		DERMOT-PIERSE, Micro-forceps	24.02	GUTHRIE, Hooks	17.01
Eye scissors	47.02	DEAN, Tonsil scissors	53.06	Gynecological scissors	56.01
Forceps micro-surgery	24.02 + 24.03	DESMARRES, Chalazion forceps	26.01		
Hooks	17.01	Lid retractors	16.01	H	
Strabismus hook	17.02	Diamond knives	18.01	HAEFLIGER, Micro Manipulator	17.08
Irrigating cannula	36.01	DIEFFENBACH, Serrefines	22.01	HALSTED-MOSQUITO, Clamps	22.02
BORES, Marking instrument	23.03	Dilators	22.01	HAMBURGER MODELL,	
BOWMAN, Probes	21.03	Dissection scissors	54.01 + 54.02	Fistula scissors	56.01
Brain scissors	55.01	Double-ended instruments	20.02	Iris forceps	24.04
BRAUWEILER, Cannula	36.01	DODEN, IOL forceps	24.07	Keratome	18.03
BUNGE, Spoons	21.01	DRAEGER, Conjunctival forceps	25.02	HAMBURGER MODELL,	
Burl plates and bars	37.02	Dressing forceps	24.01	HARMS, trabeculectomy probes	21.04
BURRATO, IOL-forceps	24.06 + 24.07	DRYSDALE, Nucleus rotator	17.07	HARTMANN-MOSQUITO, Clamps	22.02
				Healon injection cannula	36.01
C				HEBRA, Spoons	21.01
Caliper block	23.02				
Cannulas	36.				



	Page		Page		Page
HEGEMANN,		KNOLLE, Iris hook	17.04	Micro-Needleholders	27.03 – 27.05
Cardiovascular scissors	55.03 + 55.04	Irrigating vectis	36.05	Micro-Razor blade holders	35.01
HEIDELBERGER MODELL,		Posterior capsule polisher	36.05	Micro-Spatulas	17.04 + 19.05
Elevator	19.02	KNOLLE-PEARCE, Irrigating cannula	36.05	Microsurgery scissors	59.02
Iris forceps	24.04	KOCH, Micro scissors	42.01	MOORFIELD, Suture forceps	26.04
Rasparatory	19.02	Nucleus spatula	19.05	MUCK, Tonsil scissors	53.06
Strabismus scissors	46.02	Phaco chopper	19.01	MUELLER, Retractor	15.10
HEIMANN, Vitreous body scissors	49.01	Phaco splitter	17.06	MULDOON, Dilator	22.01
HELVESTON, Hook	17.03	Kortex-extractor	36.04	MURDOCK, Eye speculum	15.05
HENRY, Cilia forceps	26.02	KRAFF-UTRATA,		Muscle clamp	25.06
HESLIN, Infusion cannula	36.04	Capsulorhexis forceps	24.05	Muscle forceps	25.05
HESS, Capsule forceps	25.01	KRATZ, Capsule polisher	36.05		
Iris forceps	24.04	KRATZ-BARRAQUER, eye specula	15.09	N	
HEYMANN, Nasal scissors	53.01 + 53.03	KREISSIG, Localizer	19.04	NAGAHARA, Hydro chopper	19.01
HOFFER, Marking Instruments	23.03	KREMER, Corneal fixation forceps	25.03	Lens spatula	17.07
HOFFER-STERN,		KUGLEN, Hooks	17.03 + 17.04	Nucleus chopper	17.08
Anterior Capsulotomy scissors	40.05	KUHNT, Corneal scarifiers	19.02	Nasal scissors	53.00 -53.05
HOLTH, Punch	22.03			Needleholders	27.
Hooks	17.	L		NETTLESHIP, Dilators	22.01
HUNT, Chalazion forceps	26.01	Lacrimal cannulas	36.	NEUHANN, fixation ring	23.04
		LAGRANGE, Eye scissors	47.05	Hooks	17.05
		LAMBERT, Chalazion forceps	26.01	Nucleus cracker	17.05
I		LANCASTER, Eye speculum	15.02	NEUMANN-SHEPARD,	
Infusion (Healon) cannula	36.04	Lens manipulators	17.04 – 17.08	Marking instruments	23.03
Infusion handle	36.06	Lens nucleus rotator	17.04 – 17.08	NOYES, Iris scissors	40.01
IOL-forceps	24.06 + 24.07	LESTER, Iris forceps	24.04		
IOL-hooks	17.04 – 17.08	Lid retractors	16.01	O	
IOL-spatulas	17.04	LIEBERMAN, Eye speculum	15.01	ONG, Capsule scissors	40.05
Iris forceps	24.01 – 24.04	Micro finger	17.07	Operating scissors	55.01 + 55.02
Iris hooks	17.01 + 17.04	Ligature scissors	59.05	Optical Center markers	23.03
Iris knives	19.03	LISTER, Bandage scissors	59.06	OSHER-NEUMANN,	
Iris scissors	40.	LIVERNOIS, IOL-forceps	24.06	Marking instruments	23.03
Irrigating vectis	36.05	Lobectomy scissors	54.01 + 54.02		
		Localizer	19.04	P	
		Loops	21.02 + 36.05	PARK-GUYTON, Eye speculum	15.06
		LORDAN, Chalazion forceps	26.01	PATON, Hockeyknife	18.01
				PAUFIQUE, Suture forceps	26.04
J				PECK-JOSEPH,	
JACOBI, Reposition hooks	17.07	M		Scissors for plastic surgery	59.02
JAECKER, Suture removal knife	19.02	MACKENSEN, Keratoplasty scissors	44.02	PERWITSCHKY, Operating scissors	55.01
JAEGER, Hooks	17.02	Probes	21.04	Phaco-Keratomes	18.03
Keratomes	18.03	Magnetic probe	20.01	Pigtail, Probes	21.04
Lid plate	16.01	Marking instruments	23.02 + 23.03	PISACANO, Nucleus rotator	17.08
JAFFE, Lid retractor	16.01	MASKET, Capsulorhexis forceps	24.05	PLANGE,	
Spatula	17.04	MAUMENEE-PARK, Eye specula	15.05	foreign body instruments	20.01 + 20.02
JAFFE-KNOLLE, Iris hook	17.04	MAYO, Scissors	57.01	Plastic surgery scissors	59.01 – 59.04
JAMESON, Hook	17.02	MAYO-LEXER, Operating scissors	57.01	Platinum spatula	19.04
Muscle forceps	25.05	MAYO-STILLE, Operating scissors	57.01	POTTS-SMITH,	
JENSEN, Posterior capsule polisher	36.05	McCULLOUGH,		Cardiovascular scissors	55.04
JESS, Fixation forceps	25.02	Strabismus forceps	25.04	Dissecting scissors	55.01
Jeweller foreign body forceps	26.02	McDONALD, IOL-forceps	24.06	PRINCE, Muscle forceps	25.05
JONES, Towel clamp	22.02	McGUIRE, Eye scissors	48.02	Probe-tip cannulas	36.
JOSEPH,		Spring handle scissors	42.02	Probes	21.03 + 21.04
Nasal scissors	53.03	McINTYRE, cannulas	36.03	Punches	22.03 + 22.04
Scissors for plastic surgery	59.01	Eye speculum	15.10		
		McPHERSON,		R	
		Forceps for micro-surgery	24.02	RAININ, Air injection cannula	36.01
		IOL-forceps	24.07	RANDOLPH, Cycloclodialysis cannula	36.02
		Measuring gauges	23.03 + 23.04	Rasparatory	19.02
		MELLINGER, Eye speculum	15.02	Razor blade holders	35.01
		MELLINGER-BEARD, Eye speculum	15.02	Razor blades	35.02
		METZENBAUM,		REYNOLDS,	
		Fino delicate dissecting scissors	54.01	Artery scissors	55.02 + 59.02
		Scissors	54.01 + 54.02	Dissecting scissors	59.02
		Tonsil scissors	53.07	Fino, Dissecting scissors	59.03
		METZENBAUM-LIPISET,		REYNOLDS,	
		Dissection scissors	59.03	Micro forceps	24.02
		MEYER, Foreign body gouge	20.01	Superior rectus forceps	25.03
		MEYER-SCHWICKERATH,		Reposition hooks	17.07
		Localizer	23.02	Retractors	15.10
		MEYHOEFER, Spoons	21.01	Retrobulbar needle	36.02
		Micro-Eye speculums	15.		
		Micro-Forceps	24.02 + 24.03		
		Micro-Loops	21.02 + 36.05		



	Page		Page		Page
A		C			
ADSON, Pincès à iris	24.01	Canules	36.	Crochets	17.
AEBLI, Ciseaux oculaires	48.01	CASTROVIEJO,		Crochets a lentilles	17.04 – 17.08
AGRICOLA, Ecarteur	15.10	Blépharostats	15.03	Crochets pour l'iris	17.01 + 17.03
ALFONSO, Bléfarostat	15.10	Ciseaux à synéchiés	44.02	Curettes	21.01
Aimant	20.01	Ciseaux pour la cornée	43.03 - 44.02		
ALVIS, Instrument pour		Compas	23.02		
corps étrangers	20.01	Dilatateur	22.01		
ANEL, Canules	36.01	Marqueurs	23.02	D	
Anneau à fixation	23.04	Pince capsulaires	25.01	DEAN, Ciseaux pour les amygdales	53.06
Anses	21.02 + 36.05	Pincès à fixer	25.02	DARDENNE, Couteau Sato	18.02
ARLT, Anse	21.02	Pincès à sutures	26.03	Crochet	17.03
ARRUGA, Crochets	17.03	Porte aiguilles	27.02 - 27.05	Pince à sutures	26.04
Pincès capsulaires	25.01	Porte-lame	35.01	DAVIEL, Curettes	21.01
Porte-aiguilles	27.01	Spatules	19.05 + 20.02	DERMOT-PIERSE, Micro-pincès	24.02
ARRUGA-NIZETIC, Pince capsulaire	25.01	Trépans	23.01	DESMARRES, Pincès à chalazion	26.01
ASTON,		CASTROVIEJO-KALT,		Releveurs à paupières	16.01
Ciseaux pour chirurgie plastique	59.04	Porte-aiguille	27.01	Diamant, couteaux	18.01
ATKINSON, Canule retrobulbaire	36.02	CASTROVIEJO-SCHACHAR		DIEFFENBACH, Serrefines	22.01
AUBARET, Crochet	17.01	Marqueur	23.02	Dilatateurs	22.01
AXENFELD, Crochets	17.01	CASTROVIEJO-VANNAS, Ciseaux	40.04	DODEN, Pince pour IOL	24.07
Curettes	21.01	CAUER, Pince à chalazion	26.01	DRAEGER, Pince à conjunctiva	25.02
AYER, Pincès à chalazion	26.01	Cautére	19.03	DRYSDALE, Crochet	17.07
		CHANG, Phaco Chopper	17.07		
		Ciseaux à / pour		E	
B		amygdales	53.06 + 53.07	Ecarteurs	15.10 + 17.01
BACKHAUS, Pince à étoffe	22.02	auriculaires	55.01	ELSCHNIG, Pince à strabisme	25.04
BAIRD, Pincès à chalazion	26.01	capsulaires	40.05	Spatule	19.05
BANGERTER, Bléfarostats	15.06	cardio-vasculaires	55.01 – 55.04	ELZE, Micro-pincès	24.02
Canule-sonde	36.03	cérébraux	55.01 + 55.02	ENGLISCHES MODELL,	
Pince pour les muscles	25.08	chirurgie	55.01 + 55.02, 57.01 + 58.01	Pincès à sutures	26.06
Spatulae	19.05	chirurgie plastique	59.01 – 59.04		
BARRAQUER,		cornée	43. – 44.		
Blépharostats	15.06 + 15.07	dissection	54.01 + 54.02	F	
Ciseaux à iridectomie	40.02	disséquer	55.03 + 55.04	FENZL, Crochet	17.04
Ciseaux à microchirurgie	42.02	dure mère	55.01 + 55.02	FINE-THORNTON, Anneau à fixation	23.04
Pince à épiler les cils	26.02	énucléer	48.04	FLIERINGA, Anneaux de fixation	23.04
Pince à fixer	25.03	fistules	56.01	FOMON,	
Pince à sutures	26.06	gynécologie	56.01	Ciseaux pour le nez	53.02, 53.03, 53.06
Pincès pour la chambre antérieure	26.03	iridectomie	40.01 + 40.02	Ciseaux pour plastique	53.04, 53.05
Porte-aiguilles	27.	ligatures	59.05	FRANKFURTER MODELL, Spatule	19.04
Porte-lames	35.01	microchirurgie	40.01 - 42.02, 59.02	FREER, Releveur	19.02
BARRAQUER-MODELL FRANZ,		nez	53.00 - 53.05	FREEMAN-KILNER,	
Ciseaux pour la cornée	44.01	oculaires	47. – 48.	Ciseaux pour chirurgie plastique	59.03
BARRAQUER-OOSTERHUIS,		pansements	59.06	FUKASAKU, Crochet	17.07
Blépharostats	15.07	périnée	56.01		
BECHERT, Crochet à lentilles	17.06	pulmonaires	54.01 + 54.02		
BECHERT-MCPHERSON,		strabisme	46.	G	
Pince à sutures	26.04	ténotomie	45. + 46.	GASS, Crochet	17.03
BEER, Pince à épiler les cils	26.02	trabéculaires	40.04	GIESSEN, Dilatateur	22.01
BERKE, Pince à entropion	25.06	vasculaires vitré	49.01	Spatules	19.04
BEYER, Emporte-pièce	22.04	Ciseaux pour couper les sutures	48.03	GILL, Ciseaux capsulaires	40.05
BISHOP-HARMON, Pince à iris	24.04	CITELLI, Emporte-pièce	22.04	GILLS, Ciseaux capsulaires	40.05
Canule avec ballon	36.06	CLARK, Blépharostat	15.05	GOOD, Ciseaux pour les amygdales	53.06
Bistouris	18.01	CLAYMAN,		GOOD-SCHWECKENDIECK,	
BLASCOVIC, Pincès musculaires	25.06	Crochet à lentilles	17.02, 17.03, 17.06	Ciseaux pour les amygdales	53.06
Blépharostats	15.	IOL-pincès	24.07	GORNEY,	
BOETTCHER,		COLIBRI, Pincès à sutures	26.04 + 26.05	Ciseaux pour chirurgie plastique	59.02
Ciseaux pour les amygdales	53.06	COLIBRI-TROUTMAN,		GRADLE, Pince à épiler les cils	26.02
Boîte de silicone	37.01	Pincès à sutures	26.05	GRAEFE, Blépharostat	15.03
Boîtes inox	37.01 + 37.03	Compas	23.02	Ciseaux oculaires	47.04
BONACCOLTO,		CONWAY, Releveur à paupières	16.01	Couteau pour kératoplastie	18.01
Pincès à strabisme	25.04	COOK, Blépharostats	15.08	Couteaux à cataracte	18.02
BONNER MODELL,		COOLEY, Ciseaux cardio-vasculaires	55.03	Crochets	17.01 + 17.02
Canule irrigatoire	36.01	COTTLE BULLDOG,		Cystotomes	19.04
Ciseaux oculaires	47.02	Ciseaux pour le nez,		Pincès à fixer	25.04
Crochets	17.01	Ciseaux pour plastique	53.03	GRAETHER, Polissoir capsulaire	17.06
Pincès à microchirurgie	24.02 + 24.03	COTTLE, Ciseaux pour le nez	53.02	GRANDON, Canules	36.05
BORES, Marqueurs	23.03	Couteau pour couper les fils	19.02	GREEN, Crochet	17.02
BOWMAN Stylets	21.03	Couteaux Sato	18.02	Instrument double	20.02
BUNGE, Curettes	21.01	Couteaux à cataracte	18.02	Pince à fixer	25.03
BURATTO, Pincès pour IOL	24.06 + 24.06	Couteaux de diamant	18.01	GUTHRIE, Crochets	17.01
		Couteaux lancéolaires	18.03		
		Couteaux pour l'iris	19.03	H	
		CRANZ, Canule irrigatoire	36.02	HAEFLIGER, Micro Manipulator	17.08



	Page		Page		Page
HALSTED-MOSQUITO, Pincés	22.02	KNIGHT, Ciseaux pour le nez	53.01	MUELLER, Ecarteur	15.10
HAMBURGER MODELL,		KNOLLE, Anse à lentilles	36.05	MULDOON, Dilatateur	22.01
Ciseaux pour fistules	56.01	Crochet	17.04	MURDOCK, Bléfarostat	15.05
Couteau lancéolaire	18.03	Polissoir capsulaire	36.05		
Pince à iris	24.04	KNOLLE-PEARCE, Canule irrigatoire	36.05	N	
HARMS, Trabeculotomes	21.04	KOCH, Ciseaux à microchirurgie	42.01	NAGAHARA, Hydro Chopper	19.01
HARTMANN-MOSQUITO, Pincés	22.02	Phaco Chopper	19.01	Nucleus Chopper	17.08
Healon, Canule pour injection	36.01	Spatule	19.05	Spatule pour cristallin	17.07
HEBRA, Curettes	21.01	Kortex-extracteur	36.04	NETTLESHIP, Dilatateurs	22.01
HEGEMANN,		KRAFF-UTRATA,		NEUHANN, Anneau à fixation	23.04
Ciseaux cardio-vasculaires	55.03, 55.04	Pincés à capsulorhexis	24.05	Crochet	17.05
HEIDELBERGER MODELL,		KRATZ, Polissoir capsulaire	36.05	Instruments à implant	17.05
Ciseaux à strabisme	46.02	KRATZ-BARRAQUER,		NEUMANN-SHEPARD	
Pincés à iris	24.04	Bléfarostats	15.09	Marqueurs	23.03
Releveur	19.02	KREISSIG, Localisateur	19.04	NOYES, Ciseaux à iridectomie	40.01
Rugine	19.02	KREMER, Pince à fixation	25.03		
HEIMANN, Ciseaux à vitré	49.01	KUGLEN, Crochets	17.03 + 17.04	O	
HELVESTON, Crochet	17.03	KUHNT, Rugines pour la cornée	19.02	ONG, Ciseaux capsulaires	40.05
HENRY, Pince à épiler les cils	26.02	Kystotomes	19.04	OSHER-NEUMANN, Marqueurs	23.03
HESLIN, Canule de perfusion	36.04				
HESS, Pince capsulaire	25.01	L		P	
Pincés à iris	24.04	Lacrymal, Canules	36.	PARK-GUYTON, Bléfarostat	15.06
HEYMANN,		LAGRANGE, Ciseaux oculaires	47.05	PATON, Bistouri	18.01
Ciseaux pour le nez	53.01 + 53.03	LAMBERT, Pince à chalazion	26.01	PAUFIQUE, Pince à sutures	26.04
HOFFER, Marqueurs optiques	23.03	Lames de rasoir	35.02	PECK-JOSEPH,	
HOFFER-STERN, ciseaux	40.05	LANCASTER, Bléfarostat	15.02	Ciseaux pour plastique	53.04 + 59.02
HOLTH, Emporte-pièce	22.03	Lentilles, instruments pour	17.04 - 17.08	PERWITSCHKY, Ciseaux à chirurgie	55.01
HUNT, Pince à chalazion	26.01	LESTER, Pince à iris	24.04	Phako-Keratomes	18.03
		LIEBERMAN, Bléfarostats	15.01	Pigtail Stylets	21.04
I		Micro finger	17.07	Pincés à capsulorhexis	24.05
Instruments doubles	20.02	LIVERNOIS, Pince à IOL	24.06	Pincés à chalazion	26.01
Instruments pour corps étrangers	20.01	LISTER, Ciseaux à pansements	59.06	Pincés à entropion	25.06
IOL-instruments	17.04 + 17.08	Localisateur	19.03	Pincés à épiler les cils	26.02
IOL-pincés	24.06 + 24.07	LORDAN, Pincés à chalazion	26.01	Pince à étoffe	22.02
				Pincés à fils	26.03 - 26.06
J		M		Pincés à fixer	25.03
JACOBI,		MACKENSEN, Ciseaux	44.02	Pincés à iris	24.01 - 24.03
Crochets a réposition	17.07	Trabeculotomes	21.04	Pincés à microchirurgie	24.02 + 24.03
JAECKER, Couteau pour les fils	19.02	Marqueurs	23.02 + 23.03	Pincés à strabisme	25.04
JAEGER, Couteaux lancéolaires	18.03	MASKET, Pincés à capsulorhexis	24.05	Pincés à sutures	26.03 - 26.06
Crochets	17.02	MAUMENEE-PARK, Bléfarostat	15.05	Pincés capsulaires	25.01
Plaque, paupières	16.01	MAYO, Ciseaux à chirurgie	57.01	Pincés Mosquito	22.02
JAFFE, Releveur à paupières	16.01	MAYO-LEXER, Ciseaux à chirurgie	57.01	Pincés musculaires	25.05
Spatule	17.04	MAYO-STILLE, Ciseaux à chirurgie	57.01	Pincés pour corps étrangers	26.02
JAFFE-KNOLLE, Crochet à iris	17.04	McCULLOUGH, Pincés à strabisme	25.04	Pincés pour la chambre antérieure	26.03
JAMESON, Crochet	17.02	McDONALD, Pincés à IOL	24.06	Pincés-clamps	22.02
Pincés musculaires	25.05	McGUIRE,		PISACONO, Crochet	17.08
JENSEN, Polissoir capsulaire	36.05	Ciseaux à microchirurgie	42.02	PLANGE, manette à	
JESS, Pince à fixer	25.02	Ciseaux oculaires	48.02	corps étrangers	20.01 + 20.02
Jeweler, Pince pour corps étrangers	26.02	McINTYRE, Bléfarostats	15.10	Plateau de stérilisation	
JONES, Clamps	22.02	Canules	36.03	de silicone	37.02
JOSEPH,		McPHERSON, IOL-pincés	24.07	Polissoirs capsulaires	17.05 + 36.05
Ciseaux pour chirurgie plastique	59.01	Pincés à microchirurgie	24.02	Porte-aiguilles	27.
Ciseaux pour le nez	53.03	MELLINGER, Bléfarostat	15.02	Porte-lames	35.01
		MELLINGER-BEARD, Bléfarostat	15.02	POTTS-SMITH,	
K		METZENBAUM,		Ciseaux à dissection	55.01
KAGAWA, Phaco Chopper	17.04	Ciseaux	54.01, 54.02	Ciseaux cardio-vasculaires	55.01, 55.04
KALT, Porte aiguilles	27.01	Ciseaux pour les amygdales	53.07	PRINCE, Pincés musculaires	25.05
KANSAS, Manche pour perfusion	36.06	Fino, Ciseaux a dissection délicats	54.01		
KATZIN, Ciseaux pour la cornée	43.02	METZENBAUM-LIPSET,		R	
KAYE, Ciseaux pour chirurgie		Ciseaux à disséquer	59.03	RAININ, Canule à air	36.01
plastique	59.02 + 59.04	MEYER, Instrument pour		RANDOLPH,	
KELLY,		corps étrangers	20.01	Canule pour cyclodialyse	36.02
Ciseaux pour fistules	56.01	MEYER-SCHWICKERATH,		Règle graduée	23.04
Emporte-Pièce	22.03	Marqueur	23.02	Réglette	23.02
KELMAN, Pince	24.07	MEYHOEFER, Curettes	21.01	Releveur	19.02
Keratomes	18.03	Micro-Bléfarostats	15.	Releveurs à paupières	16.01
KERRISON, Emporte-pièce	22.04	Micro-Pincés	24.02 + 24.03	REMKY, Micro-Pincés	24.02
KILNER,		Micro-Porte-Aiguilles	27.03 - 27.05	Pincés à mors croisée	25.03
Ciseaux pour plastique	53.05, 59.04	Micro-Portes-lames	35.01	REYNOLDS	
KIMURA, Spatule	19.04	Micro-Spatules	17.04 + 19.04	Ciseaux à ténatomie	59.02
KNAPP, Couteaux pour l'iris	19.03	MOORFIELD, Pince à sutures	26.04		
		MUCK, Ciseaux pour les amygdales	53.06		



	Page		Page
REYNOLDS		TUEBINGEN, Ciseaux Vannas	40.04
Ciseaux vasculaires	55.02 + 59.02	Pincés à sutures	26.03 + 26.04
fino, Ciseaux à ténatomie	59.03	TYRELL, Crochet	17.01
ROLLET, Crochets	17.01		
Rugine à dacrio	19.03	U	
ROSEN, Hydro Chopper	19.01	URIBE-STERN, ciseaux	40.05
Phaco Chopper	19.01	UTHOFF, ciseaux	40.05
Phaco Splitter	17.06	UTRATA,	
RHOTON, Ciseaux microchirurgieaux	55.03	Pincés à capsulorhexis	24.05
RUBMANN-KATZIN,			
Polissoir capsulaire	36.05	V	
RUEDEMANN, Dilatateur	22.01	VANNAS, Ciseaux	40.03 + 40.04
Rugine à dacrio	19.02		
Rugines pour la cornée	19.02		
S		W	
ST. MARTIN, Pince à sutures	26.04	WADSWORTH-TOOD, Cautère	19.03
SATTLER, Pincés musculaires	25.05	WALDMANN, Ciseaux à périnée	56.01
SAUER, Blépharostat	15.03	WALSER, Emporte-pièce	22.03
SAUTTER, Canule à air	36.01	WALTER, Ciseaux	47.04
SCHEPENS, Releveur à paupières	16.01	WATZKE, Pince	25.06
SCHIOETZ, Tonomètres	29.01	WEBER, Anses	21.02
SCHOTT, Blépharostats	15.08	WECKER, Ciseaux à iridectomie	40.02
SCHUKNECHT, Ciseaux auriculaires	55.01	Spatule	19.05
SCHWEIZER MODELL,		WEISS, Blépharostats	15.02 + 15.04
Instrument pour corps étrangers	20.01	WELLS, Curette	21.01
Pince à épiler les cils	26.02	WEST, Canule irrigatoire	36.03
Pince capsulaire	25.01	Rugines	19.03
Tréfans	23.01	WESTCOTT,	
Sclérotomes	18.01	Ciseaux à microchirurgie	42.02
Serrefines	22.01	Ciseaux à ténatomie	45.01
SHAAF, Pince pour corps étrangers	26.02	WHEELER, Couteau à dissection	19.02
SHEA, Ciseaux neurochirurgieaux	53.04	Instrument double	20.02
SHEETS, Anse à lentilles	36.05	WILDER, Dilatateurs	22.01
SHEPARD, Canule irrigatoire	36.02	WILLIAMS, Bléfarostats	15.09
IOL-Pincés	24.07	WILMER, ciseaux	47.04
SHEPARD-KREMER, Règle	23.04	WORST, Pigtail	21.04
SIMCOE, Canules	36.04	WORTH, Pincés musculaires	25.05
Extracteur de cortex	36.03		
SINSKEY, Crochets	17.03 + 17.04	Z	
SNELLEN, Anse	21.02	ZIEGLER, Couteaux pour l'iris	19.03
Pincés à entropion	25.06	ZUERCHER MODELL, Pince à fils	26.05
Sondes	21.03		
Sondes rétrogrades	21.04		
Spatules	19.04 + 19.05		
Spatule pour kératoplastie	19.04		
SPEEMANN, Pince de joaillier à iris	26.02		
SPENCER,			
Ciseaux pour incision	48.03, 59.05		
Ciseaux à ligatures	59.05		
STEVENS,			
Ciseaux à ténatomie	46.01, 59.01, 59.03		
Crochet	17.03		
Porte-aiguilles	27.01		
STEVENSON, Ecarteur	15.10		
Stylets	21.03 - 21.04		
Super Cut Ciseaux	50.00		
T			
TENNANT, Releveur à paupières	16.01		
THORNTON, Anneau à fixation	23.04		
TOENNIS, Ciseaux cérébraux	55.01		
Tonomètres	29.01		
TOOKE, Bistouri	18.01		
Trabeculotomes	21.04		
Tréfans	23.01		
TROUTMAN,			
Alpha-Chymotrypsin canule	36.01		
Ciseaux pour la cornée	43.01		
Porte-lame	35.01		
Spatule	19.05		



	Página		Página		Página
A		F		F	
ADSON, Pinzas para iris	24.01	CASTROVIEJO, Blefaróstatos	15.03	FENZL, Gancho	17.04
AEBLI, Tijeras oculares	48.01	Compás	23.02	FINE-THORNTON, Anillo de fijación	23.04
AGRICOLA, Separador	15.10	Dilatadores	22.01	FLIERINGA, Anillos de fijación	23.04
ALFONSO, Blefarostato	15.10	Espátulas	19.05 + 20.02	FOMON,	
ALVIS, Instrumento para		Marcadores	23.02	Tijeras nasales	53.02 + 53.03 + 53.06
cuerpos extraños	20.01	Pinza capsular	25.01	Tijeras para cirugía plástica	53.04 + 53.05
ANEL, Cánulas	36.01	Pinzas de fijación	25.02	FRANKFURTER MODELL, Espátula	19.04
ARLT, Asa	21.02	Pinzas para suturas	26.03	FREEMAN-KILNER,	
ARRUGA, Ganchos	17.03	Porta-agujas	27.02 + 27.05	Tijeras para cirugía plástica	59.03
Pinzas capsulares	25.01	Porta-hojas	35.01	FREER, Elevador	19.02
Porta-agujas	27.01	Tijeras de sinequia	44.02	FUKASAKU, Gancho	17.07
ARRUGA-NIZETIC, Pinza capsular	25.01	Trépanos	23.01		
Asas	21.02 + 36.05	Tijeras para la cornea	43.03 - 44.02		
ASTON, Tijeras para cirugía plástica	59.04	CASTROVIEJO-KALT, Porta-agujas	27.01		
ATKINSON, Cánula retrobulbar	36.02	CASTROVIEJO-SCHACHAR;		G	
AUBARET, Gancho	17.01	Marcador	23.02	Ganchos	17.
AXENFELD, Cucharilla	21.01	CASTROVIEJO-VANNAS, Tijeras	40.04	Ganchos de fijación	25.03
Ganchos	17.01	CAUER, Pinza de chalazion	26.01	GASS, Gancho	17.03
AYER, Pinza de chalazion	26.01	Cauterio	19.03	GIESSEN, Espátula	19.04
		CHANG, Phaco Chopper	17.01	Dilatador	22.01
		Cinzel	19.03	GILL, Tijeras para cápsula	40.05
		CITELLI, Pinza gubia	22.04	GOOD, Tijera para amígdalas	53.06
B		CLARK, Blefaróstatos	15.05	GOOD-SCHWECKENDIECK,	
BACKHAUS, Pinza de campo	22.02	CLAYMAN, Gancho para lentes	17.06	Tijera para amígdalas	53.06
BAIRD, Pinza de chalazion	26.01	IOL-gancho	17.02 + 17.03	GORNEY,	
Bandejas para la esterilización	37.01 - 37.02	IOL-pinzas	24.07	Tijeras para cirugía plástica	59.02
BANGERTER, Blefaróstatos	15.06	COLIBRI,		GRADLE, Pinza depilatoria	26.02
Cánula tipo sonda	36.03	Pinzas para suturas	26.04 + 26.05	GRAEFE, Blefarostato	15.03
Espátulas	19.05	COLIBRI TROUTMAN,		Cuchillos para cataratas	18.02
Pinzas de músculo	25.08	Pinzas para suturas	26.05	Escarificador	18.01
BARRAQUER,		CONWAY, Retractor para párpados	16.01	Ganchos	17.01 + 17.02
Blefaróstatos	15.06 + 15.07	COOK, Blefaróstatos	15.08	Pinzas de fijación	25.04
Pinza de fijación	25.03	COOLEY, Tijeras cardiovasculares	55.03	Quistótomos	19.04
Pinza depilatoria	26.02	COTTLE BULLDOG, Tijeras nasales	53.03	Tijeras oculares	47.04
Pinza para la cámara anterior	26.03	COTTLE, Tijeras nasales	53.02	GRAETHER, Pulidor de cápsula	17.06
Pinza para quitar suturas	26.06	CRANZ, Cánula para irrigación	36.02	GRANDON, Cánula	36.05
Porta-agujas	27.	Cucharillas	21.01	GREEN, Gancho	17.02
Porta-hojas	35.01	Cuchillos lanceolares	18.03	Instrumento doble	20.02
Tijeras para iridectomía	40.02	Cuchillos para cataratas	18.02	Pinza de fijación	25.03
Tijeras para microcirugía	42.02	Cuchillo para cortar suturas	19.02	GUTHRIE, Ganchos	17.01
BARRAQUER-MODELL FRANZ,		Cuchillos para iris	19.03		
tijeras para córnea	44.01	Cuchillos Sato	18.02	H	
BARRAQUER-OOSTERHUIS,				HAEFLIGER, Micromanipulador	17.08
Blefaróstatos	15.07	D		HALSTED-MOSQUITO,	
BECHERT, Gancho para lentes	17.06	DARDENNE, Cuchillo Sato	18.02	Pinzas-clamps	22.02
BECHERT-McPHERSON, Pinza	26.04	Ganchos	17.03	HAMBURGER MODELL	
BEER, Pinza depilatoria	26.02	DAVIEL, Cucharillas	21.01	Cuchillo lanceolare	18.03
BERKE, Pinza de entropion	25.06	DEAN, Tijera para amígdalas	53.06	Pinzas para iris	24.04
BEYER, Punzón	22.04	DERMOT-PIERSE, Micro-Pinza	24.02	Tijeras para fistulas	56.01
BISHOP-HARMON,		DESMARRES, Pinzas de chalazion	26.01	HARMS, Trabeculótomos	21.04
Cánula con pera	36.06	Retractores para párpados	16.01	HARTMANN-MOSQUITO,	
Pinza para iris	24.04	DIEFFENBACH, Serra-finas	22.01	Pinzas clamps	22.02
Bisturíes	18.01	Dilatadores	22.01	Healon, Cánula para inyección	36.01
Bisturíes diamante	18.01	DODEN, IOL pinzas	24.07	HEBRA, Cucharillas	21.01
BLASCOVIC, Pinzas de entropion	25.06	DRAEGER, Pinza para conjuntiva	25.02	HEGEMANN,	
Blefaróstatos	15.	DRYSDALE, Rotador de núcleo	17.07	Tijeras vascular	55.03 + 55.04
BOETTCHER, Tijeras para amígdalas	53.06			HEIDELBERGER MODELL,	
BONACCOLTO,		E		Elevador	19.02
Pinzas para estrabismo	25.04	Elevador	19.02	Legra	19.02
BONNER MODELL,		ELSCHNIG, Espátulas	19.05	Pinza para iris	24.04
Cánula para irrigación	36.01	Pinza para estrabismo	25.04	Tijeras para estrabismo	46.02
Ganchos	17.01	ELZE, Micro-Pinzas	24.02	HEIMANN, tijeras	49.01
Pinzas para microcirugía	24.02 + 24.03	ENGLISHES MODELL,		HELVESTON, Gancho	17.03
Tijeras oculares	47.02	Pinzas para suturas	26.06	HENRY, Pinza depilatoria	26.02
BORES, Marcadores	23.03	Esclerótomos	18.01	HESLIN, Cánula para infusión	36.04
BOWMAN, Estiletes	21.03	Espátulas	19.04 + 19.05	HESS, Pinza capsular	25.01
BRAUWEILER, canula	36.01	Espátulas, IOL	17.04	Pinzas para iris	24.04
BUNGE, Cucharillas	21.01	Espátula para queratoplastia	19.04	HEYMANN, Tijeras nasales	53.01 + 53.03
BURATTO, Pinzas para IOL	24.06 + 24.07	Estiletes	21.03 + 21.04	HOFFER, Marcadores	23.03
		Extractor para corteza	36.04	HOFFER-STERN, Tijeras	40.05
				Hojas de afeitar	35.02
C				HOLTH, Punzón	22.03
Cajas para esterilizar	37.01 + 37.03			HUNT, Pinza de chalazion	26.01
Cánulas	36.				



	Página
SIMCOE, Cánulas	36.04
Extractor para corteza	36.03
SINSKEY, Ganchos	17.03 + 17.04
SNELLEN, Asa	21.02
Pinzas de entropion	25.06
SPEEMANN,	
Pinza de joyero para iris	26.02
SPENCER,	
Tijeras para incisión	48.03, 59.05
Tijeras para ligadura	59.05
STEVENS, Gancho	17.03
Porta-agujas	27.01
Tijeras para tenotomía	46.01, 53.00 59.01, 59.03
STEVENSON, Separador	15.10
Super Cut Tijeras	50.00
T	
TENNANT, Retractor para párpados	16.01
THORNTON, Anillo de fijación	23.04
Tijeras auricular	55.01
Tijeras cardiovasculares	55.01 - 55.04
Tijeras cerebrales	55.01 + 55.02
Tijeras dura-madre	55.01 + 55.02
Tijeras nasales	53.00 - 53.05
Tijeras naselas	53.00 - 53.05
Tijeras oculares	47. - 48.
Tijeras para amígdalas	53.06 + 53.07
Tijeras para cápsula	40.05
Tijeras para cirugía plástica	59.01 - 59.04
Tijeras para cirugía	55.01 + 55.02, 57.01, 58.01
Tijeras para cuerpo vítreo	49.01
Tijeras para disección	54.01 + 54.02
Tijeras para enucleación	48.04
Tijeras para estrabismo	46.
Tijeras para fístulas	56.01
Tijeras para ginecología	56.01
Tijeras para incisión	48.03
Tijeras para iridectomía	40.
Tijeras para la córnea	43. - 44.
Tijeras para ligadura	59.05
Tijeras para ligadura	59.05
Tijeras para microcirugía	40. - 42.
Tijeras para microcirugía	59.02
Tijeras para perineo	56.01
Tijeras para tenotomía	45.01+ 46.01
Tijeras para vendajes	59.06
Tijeras pulminares	54.01 + 54.02
Tijeras thoracoplástica	55.01 + 55.02
Tijeras trabeculares	40.04
Tijeras vascular	55.03 + 55.04
TOENNIS, Tijeras cerebrales	55.01
Tonómetros	29.01
TOOKE, Cuchillo para la córnea	18.01
Trabeculótomos	21.04
Trépanos	23.01
TROUTMAN,	
Alpha-Chymotrypsin cánula	36.01
Asa	21.02
Espátula	19.05
Porta-hoja	35.01
Tijeras para la córnea	43.01
TUEBINGER MODELL,	
Pinza para suturas	26.03 + 26.04
Tijeras Vannas	40.04
TYRELL, Gancho	17.01
U	
URIBE-STERN, Tijeras	40.05
UTHOFF, Tijeras	40.05
UTRATA,	
Pinzas capsulorhexis	24.05

V

VANNAS, Tijeras 40.03 + 40.04

W

WADSWORTH-TODD, Cauterio	19.03
WALDMANN, Tijera para perineo	56.01
WALSER, Punzón	22.03
WALTER, Tijeras	47.04
WATZKE, Pinza	25.06
WEBER, Asas	21.02
WECKER, Espátulas	19.05
Tijeras para iridectomía	40.02
WEISS, Blefaróstatos	15.02 + 15.04
WELLS, Cucharilla	21.01
WEST, Cánula para irrigación	36.03
Cíncel	19.03
WESTCOTT,	
Tijeras para microcirugía	42.02
Tijeras para tenotomía	45.01
WHEELER, Cuchillo para discission	19.02
Instrumento doble	20.02
WILDER, Dilatadores	22.01
WILLIAMS, Blefaróstatos	15.09
WILMER, Tijeras	47.04
WORST, Pigtail Estilete Lacrimal	21.04
WORTH, Pinzas musculares	25.05

Z

ZIEGLER, Cuchillos para iris	19.03
ZUERCHER MODELL,	
Pinza para suturas	26.05

CARL TEUFEL GMBH & CO. KG
FABRIK CHIRURGISCHER INSTRUMENTE
SEIT – SINCE – DEPUIS – DESDE 1921



TEUFEL®



Registered trademarks
Eingetragene Warenzeichen

Copyright 2009 by
CARL TEUFEL GMBH & CO. KG
All rights reserved.

Urheberrecht. Nachdruck und
Missbrauch verboten.
Unverkäufliches Eigentum der
Fa. CARL TEUFEL GMBH & CO. KG
Printed in Germany

INSTRUMENTE CHIRURGISCHE INSTRUMENTE
CHIRURGISCHE INSTRUMENTE CHIRURGISCHE
INSTRUMENTS SURGICAL INSTRUMENTS
SURGICAL INSTRUMENTS SURGICAL
DE CHIRURGIE INSTRUMENTS DE CHIRURGIE
INSTRUMENTS DE CHIRURGIE INSTRUMENTS
PARA CIRUGIA INSTRUMENTOS PARA CIRUGIA
INSTRUMENTOS PARA CIRUGIA INSTRUMENTOS
INSTRUMENTE CHIRURGISCHE INSTRUMENTE
CHIRURGISCHE INSTRUMENTE CHIRURGISCHE
INSTRUMENTS SURGICAL INSTRUMENTS
SURGICAL INSTRUMENTS SURGICAL
DE CHIRURGIE INSTRUMENTS DE CHIRURGIE
INSTRUMENTS DE CHIRURGIE INSTRUMENTS
PARA CIRUGIA INSTRUMENTOS PARA CIRUGIA
INSTRUMENTOS PARA CIRUGIA INSTRUMENTOS
INSTRUMENTE CHIRURGISCHE INSTRUMENTE
CHIRURGISCHE INSTRUMENTE CHIRURGISCHE
INSTRUMENTS SURGICAL INSTRUMENTS
SURGICAL INSTRUMENTS SURGICAL
DE CHIRURGIE INSTRUMENTS DE CHIRURGIE
INSTRUMENTS DE CHIRURGIE INSTRUMENTS
PARA CIRUGIA INSTRUMENTOS PARA CIRUGIA
INSTRUMENTOS PARA CIRUGIA INSTRUMENTOS

