

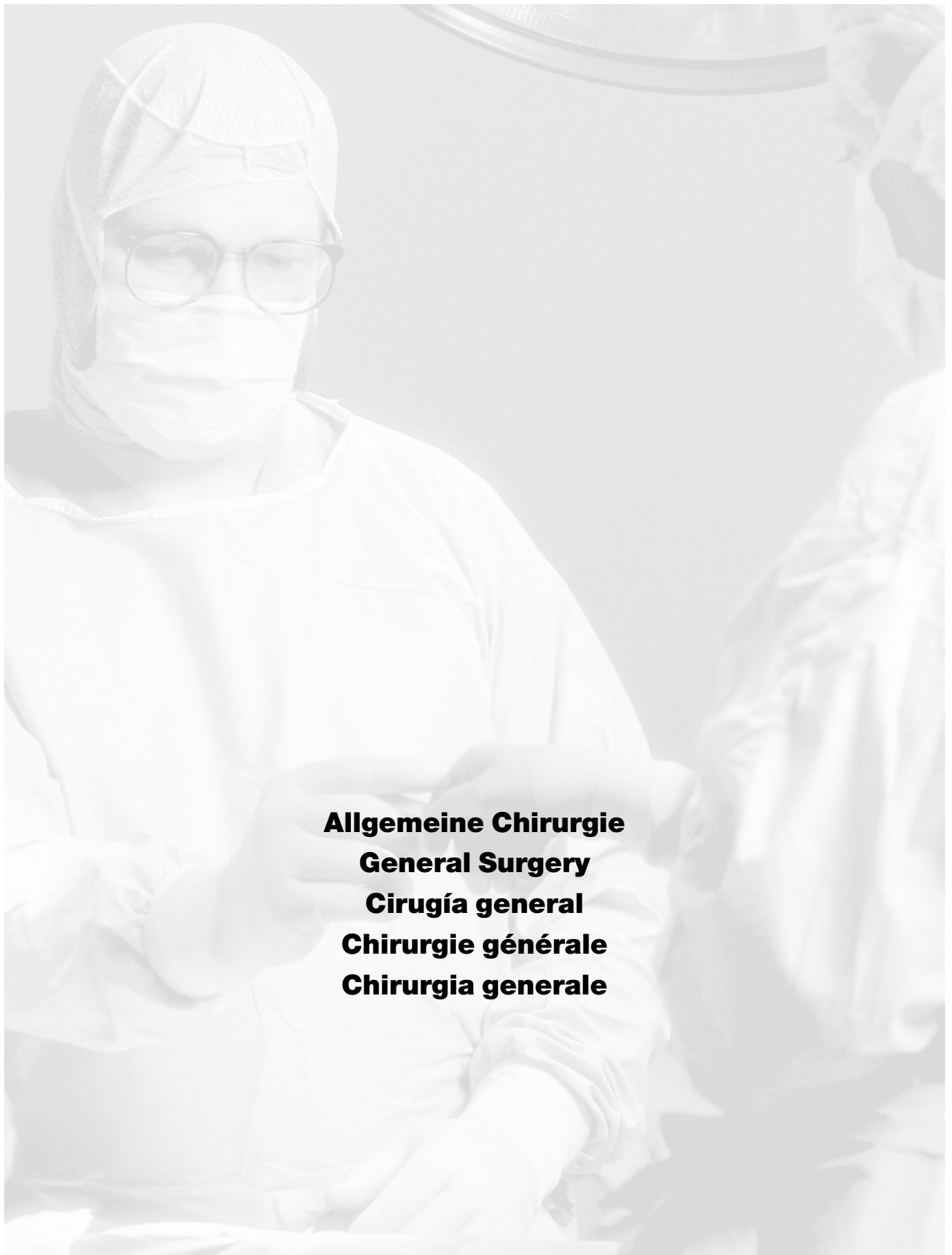

---

best of basic instruments

**Allgemeine Chirurgie**  
**General Surgery**  
**Cirugía general**  
**Chirurgie générale**  
**Chirurgia generale**



**Allgemeine Chirurgie**  
**General Surgery**  
**Cirugía general**  
**Chirurgie générale**  
**Chirurgia generale**

### **bob instruments – best of basic**

- **Komplettes Programm an Standardinstrumenten**
- **Attraktives Preis-Leistungsverhältnis**
- **Hohe Lieferfähigkeit**
- **Geprüfte Qualität durch Anwendung von MEDICON-Qualitätsstandards basierend auf über 60 Jahren Erfahrung**
- **CE-Zertifiziert**

**Ein Tochterunternehmen der MEDICON-Firmengruppe**

### **bob instruments – best of basic**

- **full range of standard instruments**
- **attractive prices and service**
- **huge quantities ex stock**
- **inspected quality by using MEDICON quality standards based on more than 60 years experience**
- **CE certified**

**A subsidiary of the MEDICON group of companies**

### **bob instruments – best of basic**

- **gama completa de instrumental estándar**
- **relación eficaz entre precio y servicio**
- **alta disponibilidad del instrumental**
- **calidad inspeccionada según el estándar de MEDICON fundandose en la experiencia de más de 60 años**
- **certificado CE**

**Una sociedad filial del Grupo MEDICON**

**bob instruments – best of basic**

- programme complet d'instruments standard
- prix et service attractives
- quantités comprehensives livrables de stock
- qualité contrôlée selon les standards de qualité  
**MEDICON se basant sur plus de 60 ans d'expérience**
- certifié CE

**Une filiale du group MEDICON**

**bob instruments – best of basic**

- programma completo di strumentario base
- rapporto costo beneficio attraente
- alta disponibilità
- qualità controllata tramite standard  
**MEDICON su base di più di 60 anni d'esperienza**
- certificato CE

**Una compagnia affiliata al gruppo MEDICON**



**Inhaltsübersicht**  
**Index • Indice general**  
**Index général • Indice generale**

**Skalpelle**  
**Scalpels • Bisturís**  
**Bistouris • Bisturi** 1 - 4

**Scheren**  
**Scissors • Tijeras**  
**Ciseaux • Forbici** 5 - 22

**Pinzetten**  
**Forceps • Pinzas**  
**Pinces • Pinze** 23 - 38

**Sauginstrumente**  
**Aspirating Instruments • Instrumentos de aspiración**  
**Instrumentos à aspiration • Strumenti per aspirazione** 39 - 42

**Nadelhalter**  
**Needle Holders • Porta-agujas**  
**Porte-aiguilles • Port'aghi** 43 - 54

**Klemmen**  
**Forceps • Pinzas**  
**Pinces • Pinze** 55 - 82

**Kornzangen**  
**Dressing Forceps • Pinzas para curaciones**  
**Pinces à pansements • Pinze per medicazione** 83 - 90

**Wundhaken**  
**Retractors • Separadores**  
**Ecarteurs • Divaricatori** 91 - 106

**Wundspreizer**  
**Self-retaining Retractors • Separadores autoestáticos**  
**Ecarteurs autostatiques • Divaricatori autostatici** 107 - 110

**Knochenchirurgie**  
**Bone Surgery • Cirugia ósea**  
**Chirurgie osseuse • Chirurgia ossea** 111 - 116

## **Inhaltsübersicht** **Index • Indice general** **Index général • Indice generale**

<b>Verband</b> <b>Dressings • Vendajes</b> <b>Pansements • Bendaggi</b>	<b>117 – 120</b>
<b>Nagelzangen</b> <b>Nail Nippers • Pinzas para cortar uñas</b> <b>Pinces pour couper les ongles • Tronchesine per unghie</b>	<b>121 – 124</b>
<b>Diagnostik</b> <b>Diagnostics • Diagnóstico</b> <b>Diagnostic • Diagnostica</b>	<b>125 – 126</b>
<b>Magen, Darm, Rektum</b> <b>Stomach, Intestines, Rectum • Estómago, Intestinos, Recto</b> <b>Estomac, Intestins, Rectum • Stomaco, Intestini, Retto</b>	<b>127 – 134</b>
<b>Galle, Niere, Urologie</b> <b>Gall bladder, Kidney, Urology • Biliares, Renales, Urología</b> <b>Vésicule biliaire, Reins, Urologie • Biliari, Renali, Urologia</b>	<b>135 – 138</b>
<b>Gynäkologie</b> <b>Gynecology • Ginecología</b> <b>Gynécologie • Ginecologia</b>	<b>139 – 150</b>
<b>Geburtshilfe</b> <b>Obstetrics • Obstetricia</b>	<b>151 – 156</b>
<b>Obstétrique • Ostetricia</b>	
<b>HNO</b> <b>ENT • ORL</b> <b>ORL • ORL</b>	<b>157 – 171</b>
<b>Numerischer Index</b> <b>Numerical Index • Indice numérico</b> <b>Index numérique • Indice numerico</b>	<b>173 – 179</b>
<b>Alphabetischer Index</b> <b>Alphabetical Index • Indice alfabético</b> <b>Index alphabétique • Indice alfabetico</b>	<b>181 – 200</b>

Der Ihnen vorliegende bob-Katalog bleibt unser Eigentum, auch wenn eine Leih- oder Schutzgebühr bezahlt wurde. Er darf nur zum Einkauf und Vertrieb der darin beschriebenen Produkte durch den dazu autorisierten Fachhandel und für die Bedarfsbeschaffung durch den jeweiligen Anwender verwendet werden. Seine Verwendung gegen unsere Inter-

This present bob catalogue remains exclusively our property even if a lending fee or charge has been paid for it. It shall be used only by specialized dealers to buy and sell products or by individual users to meet their own requirements. In case of misuse

El catálogo bob que Vd. tiene ante sí queda de nuestra propiedad hasta si hubiesen sido pagados ciertos derechos de préstamo de custodia. A los revendedores autorizados del ramo debe servir exclusivamente para la compra y la distribución de los productos que describe y a los especialistas y usuarios particulares para escoger los instrumentos necesarios para su abastecimiento. Su empleo

Le présent catalogue bob demeure notre propriété, même après acquittement d'une taxe autorisée ou taxe de prêt. Il ne peut être utilisé que pour l'achat ou la vente des produits qui y sont décrits, par des spécialistes et étant autorisés et par l'utilisateur correspondant pour l'approvisionnement de ses besoins. Son utilisation contre nos intérêts nous

Il presente catalogo bob rimane di nostra proprietà anche se è stato pagato un diritto di noleggio o di proprietà riservata. Esso può essere adoperato soltanto per l'acquisto e la vendita dei prodotti ivi descritti attraverso il commercio specializzato e autorizzato o per l'approvvigionamento tramite chi, di volta in volta, li impiega. L'uso dei catalogo con-

essen berechtigt uns zur sofortigen Rückforderung und möglichen weitergehenden Maßnahmen.

Ohne unsere ausdrückliche, schriftliche Genehmigung darf dieser Katalog weder im Gesamten noch auszugsweise nachgedruckt oder kopiert werden.

we are entitled to recall the catalogue immediately and to take further steps if necessary.

It is not allowed to reprint or copy this catalogue in whole or in partially without our written permission.

abusivo en perjuicio de nuestros intereses, nos da derecho a exigir su restitución inmediata y a tomar todas las medidas ulteriores que juzguemos necesarias.

Salvo nuestro permiso expreso por escrito, quedan prohibidas la reproducción tipográfica o por calca-dor, tanto en total como en extractos.

autorise à une demande en restitution immédiate et à la prise éventuelle de mesures allant plus loin.

Sans autorisation formelle écrite, ce catalogue ne peut être ni réimprimé, ni copié, que ce soit complètement ou partiellement.

tro i nostri interessi ci autorizza al suo immediato ritiro e possibili ulteriori provvedimenti.

Senza la nostra esplicita autorizzazione scritta questo catalogo non può essere ristampato o copiato né integralmente né parzialmente.

Gedruckt in Deutschland  
Printed in Germany  
Impreso en Alemania  
Imprimé en Allemagne  
Stampato in Germania  
Trykket i Tyskland

© Copyright 2008, bob instruments GmbH, Tuttlingen, Germany

Modelländerungen vorbehalten  
Patterns are subject to change  
Salvo modificaciones  
Tous droits réservés des changements de modèle  
Ci riserviamo la facoltà di cambiamenti nei modelli

Für Druckfehler übernehmen wir keinerlei Haftung  
We are not liable for misprints  
Declinamos toda responsabilidad por los errores de impresión que pueda contener este documento  
Nous déclinons toute responsabilité en cas d'erreurs d'impression  
Non ci assumiamo nessuna responsabilità per eventuali errori di stampa

**bob**  
instruments

best of basic instruments



**Skalpelle**  
**Scalpels**  
**Bisturís**  
**Bistouris**  
**Bisturi**





**Skalpelle**  
**Scalpels • Bisturís**  
**Bistouris • Bisturi**

---



**1022.10**  
# 10



**1022.11**  
# 11



**1022.15**  
# 15

Skalpellklingen, passend für die Skalpellgriffe no. 3, no. 3L, no. 7

Scalpel blades for scalpel handles no. 3, no. 3L, no. 7

Hojas de bisturí para mangos de bisturí no. 3, no. 3L, no. 7

Lames de bistouris pour manches de bistouris no. 3, no. 3L, no. 7

Lame per bisturi per bisturi no. 3, no. 3L, no. 7



**1022.20**  
# 20



**1022.23**  
# 23



**1022.24**  
# 24

Skalpellklingen, passend für die Skalpellgriffe no. 4, no. 4L

Scalpel blades for scalpel handles no. 4, no. 4L

Hojas de bisturí para mangos de bisturí no. 4, no. 4L

Lames de bistouris pour manches de bistouris no. 4, no. 4L

Lame per bisturi per bisturi no. 4, no. 4L

Verpackungseinheit 100 Stück, steril

Packing unit 100 pieces, sterile

Cajas de 100 piezas, estériles

Boîtes de 100 pièces, stériles

Unità di 100 pezzi, sterili

**Skalpelle**  
**Scalpels • Bisturís**  
**Bistouris • Bisturi**

---



**1072.03**  
no. 3



**1072.13**  
no. 3L



**1082.04**  
no. 4



**1082.14**  
no. 4L



**1072.07**  
no. 7



**bob**  
instruments

best of basic instruments



**Scheren**  
**Scissors**  
**Tijeras**  
**Ciseaux**  
**Forbici**

**Feine Scheren**  
**Delicate Scissors • Tijeras finas**  
**Ciseaux délicats • Forbici delicate**

---



12 cm – 4¾"  
**Wagner**



**2060.02**



**2070.02**



12 cm – 4¾"  
**Wagner**



**2060.12**



**2070.12**



12 cm – 4¾"  
**Wagner**



**2060.32**



**2070.32**



**Irisscheren**  
**Iris Scissors • Tijeras para iridectomia**  
**Ciseaux à iridectomie • Forbici per iridectomia**

---



**Iris Standard**

9 cm – 3½"

10,5 cm – 4¼"

11,5 cm – 4½"



**2002.09**

**2002.10**

**2002.11**



**2012.09**

**2012.10**

**2012.11**



9 cm – 3½"  
**Micro-Iris**



**2002.30**



**2012.30**



**Feine Scheren**  
**Delicate Scissors • Tijeras finas**  
**Ciseaux délicats • Forbici delicate**

---



**2004.12**



**2014.12**



12 cm – 4¾"



**2005.02**



**2005.03**



**2005.12**



**2005.13**



11,5 cm – 4½"  
**Stevens**

11,5 cm – 4½"  
**Stevens**



**Feine Scheren**  
**Delicate Scissors • Tijeras finas**  
**Ciseaux délicats • Forbici delicate**

---



**4045.16**

**4055.16**

16 cm – 6¼"  
**Kelly**



**4008.13**

**4018.13**

13 cm – 5⅛"  
**Fox**





**3020.14**

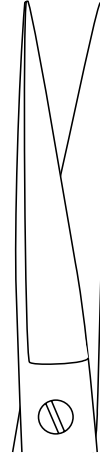

**3040.14**

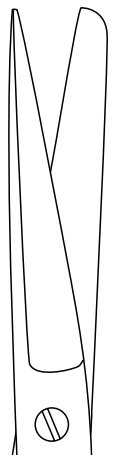

**3060.14**

10,5 cm – 4 $\frac{1}{8}$ "      **3020.10**  
 11,5 cm – 4 $\frac{1}{2}$ "      **3020.11**  
 13,0 cm – 5 $\frac{1}{8}$ "      **3020.13**  
 14,5 cm – 5 $\frac{3}{4}$ "      **3020.14**  
 15,0 cm – 6"      **3020.15**  
 16,5 cm – 6 $\frac{1}{2}$ "      **3020.16**  
 18,5 cm – 7 $\frac{1}{4}$ "      **3020.18**

**3040.10**  
**3040.11**  
**3040.13**  
**3040.14**  
**3040.15**  
**3040.16**  
**3040.18**

**3060.10**  
**3060.11**  
**3060.13**  
**3060.14**  
**3060.15**  
**3060.16**  
**3060.18**



**Chirurgische Scheren**  
**Operating Scissors • Tijeras quirúrgicas**  
**Ciseaux chirurgicaux • Forbici chirurgiche**

---



**3030.14**



**3050.14**



**3070.14**

10,5 cm – 4 $\frac{1}{8}$ "

**3030.10**

**3050.10**

**3070.10**

11,5 cm – 4 $\frac{1}{2}$ "

**3030.11**

**3050.11**

**3070.11**

13,0 cm – 5 $\frac{1}{8}$ "

**3030.13**

**3050.13**

**3070.13**

14,5 cm – 5 $\frac{3}{4}$ "

**3030.14**

**3050.14**

**3070.14**

15,0 cm – 6"

**3030.15**

**3050.15**

**3070.15**

16,5 cm – 6 $\frac{1}{2}$ "

**3030.16**

**3050.16**

**3070.16**

18,5 cm – 7 $\frac{1}{4}$ "

**3030.18**

**3050.18**

**3070.18**

**Chirurgische Scheren**  
**Operating Scissors • Tijeras quirúrgicas**  
**Ciseaux chirurgicaux • Forbici chirurgiche**

---

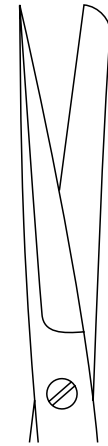

**3080.14**



**3090.14**

14 cm – 5½"

**Deaver**

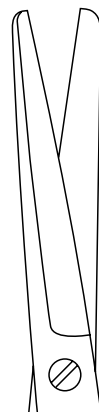

**3001.15**



**3011.15**

15,5 cm – 6¼"

**Mixer**

**Präparierscheren**  
**Dissecting Scissors • Tijeras para disección**  
**Ciseaux à dissection • Forbici per dissezione**

---



**Mayo**

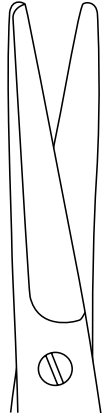

**3005.14**  
14 cm – 5½"

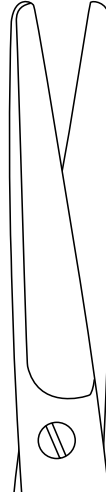

**3005.17**  
17 cm – 6¾"

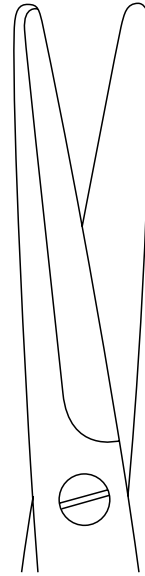

**3005.23**  
23 cm – 9"



**3015.14**  
14 cm – 5½"



**3015.17**  
17 cm – 6¾"



**3015.23**  
23 cm – 9"

**Präparierscheren**  
**Dissecting Scissors • Tijeras para disección**  
**Ciseaux à dissection • Forbici per dissezione**

---



**Mayo-Style**

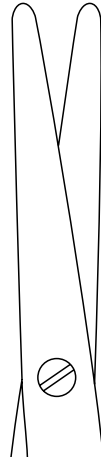

**3065.15**  
15 cm – 6"

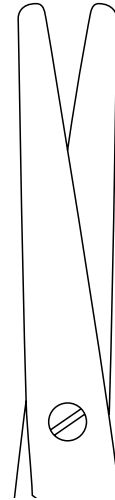

**3065.17**  
17 cm – 6¾"



**3075.15**  
15 cm – 6"



**3075.17**  
17 cm – 6¾"

**Präparierscheren**  
**Dissecting Scissors • Tijeras para disección**  
**Ciseaux à dissection • Forbici per dissezione**

---



16 cm – 6¼"  
**Mayo-Lexer**

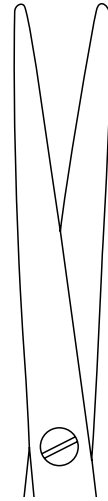

**3065.86**



**3075.86**



**Präparierscheren**  
**Dissecting Scissors • Tijeras para disección**  
**Ciseaux à dissection • Forbici per dissezione**

---



**4023.11**  
11,5 cm – 4½"  
**Baby-Metzenbaum**



**Metzenbaum**



**4023.14**  
14 cm – 5½"



**4023.18**  
18 cm – 7¼"



**4023.20**  
20 cm – 8"



**Präparierscheren**  
**Dissecting Scissors • Tijeras para disección**  
**Ciseaux à dissection • Forbici per dissezione**

---



**4033.11**  
11,5 cm – 4½"  
**Baby-Metzenbaum**



**Metzenbaum**



**4033.14**  
14 cm – 5½"



**4033.18**  
18 cm – 7½"



**4033.20**  
20 cm – 8"



**Präparierscheren**  
**Dissecting Scissors • Tijeras para disección**  
**Ciseaux à dissection • Forbici per dissezione**

---

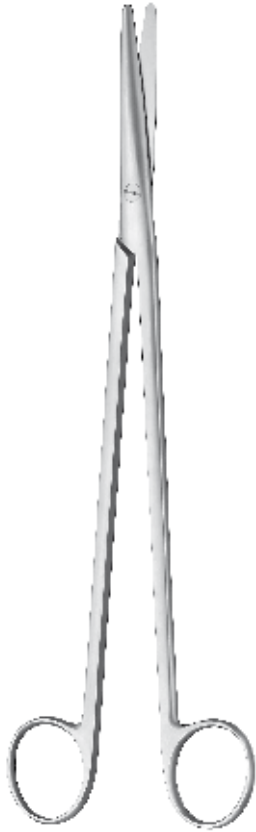

**Nelson-Metzenbaum**



**4023.23**  
23 cm – 9"

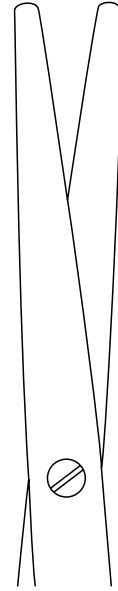

**4023.26**  
26 cm – 10¼"



**4033.23**  
23 cm – 9"

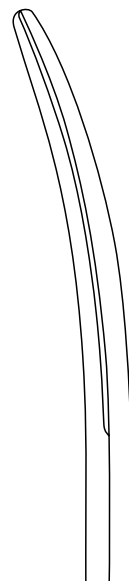

**4033.26**  
26 cm – 10¼"



**Präparierscheren**  
**Dissecting Scissors • Tijeras para disección**  
**Ciseaux à dissection • Forbici per dissezione**

---



**Metzenbaum-slim**



**4043.14**  
14 cm – 5½"



**4043.18**  
18 cm – 7¼"



**4053.14**  
14 cm – 5½"



**4053.18**  
18 cm – 7¼"

**Fadenscheren**  
**Stitch Scissors • Tijeras de sutura**  
**Ciseaux à ligatures • Forbici per legature**

---



**Spencer**



**4160.09**  
9 cm – 3½"



**4160.10**  
10,5 cm – 4⅛"



**4160.12**  
12 cm – 4¾"



**4160.13**  
13 cm – 5⅛"  
**Littauer**

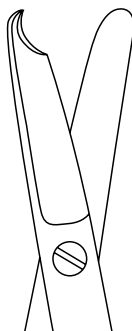

## Drahtscheren

Wire Cutting Scissors • Tijeras para cortar hilo de acero  
Ciseaux coupe-fil • Forbici tagliafili d'acciaio

---

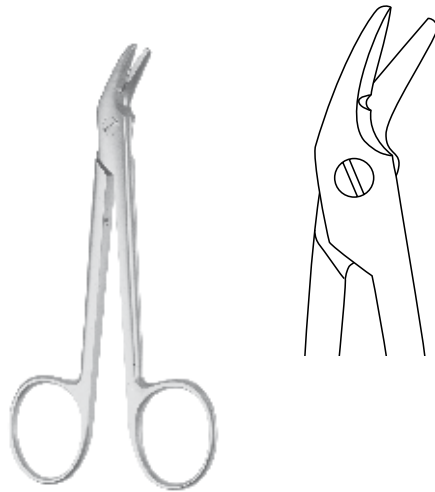

**4132.12**  
12 cm – 4¾"  
**Universal**



**Beebee**

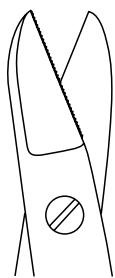

**4142.12**  
12,5 cm – 5"



**4152.12**  
12,5 cm – 5"



**4162.10**  
10,5 cm – 4¼"



**4172.10**  
10,5 cm – 4¼"





**Pinzetten**  
**Forceps**  
**Pinzas**  
**Pinces**  
**Pinze**



**Anatomische Pinzetten**  
**Dressing Forceps • Pinzas anatómicas**  
**Pinces anatomiques • Pinze anatomiche**

---



**6000.10**  
10,5 cm – 4 $\frac{1}{8}$ "



**6000.11**  
11,5 cm – 4 $\frac{1}{2}$ "



**6000.13**  
13 cm – 5 $\frac{1}{8}$ "



**6000.14**  
14,5 cm – 5 $\frac{3}{4}$ "



**6000.16**  
16 cm – 6 $\frac{1}{4}$ "



**6000.18**  
18 cm – 7 $\frac{1}{8}$ "



**6000.20**  
20 cm – 8"



**6000.25**  
25 cm – 10"



**6000.30**  
30 cm – 11 $\frac{3}{4}$ "



**Chirurgische Pinzetten**  
**Tissue Forceps • Pinzas quirúrgicas**  
**Pinces quirúrgicas • Pinze chirurgiche**

---

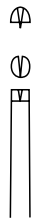

**6050.10**  
10,5 cm – 4 $\frac{1}{8}$ "



**6050.11**  
11,5 cm – 4 $\frac{1}{2}$ "



**6050.13**  
13 cm – 5 $\frac{1}{8}$ "



**6050.14**  
14,5 cm – 5 $\frac{3}{4}$ "



**6050.16**  
16 cm – 6 $\frac{1}{4}$ "



**6050.18**  
18 cm – 7 $\frac{1}{8}$ "



**6050.20**  
20 cm – 8"



**6050.25**  
25 cm – 10"



**6050.30**  
30 cm – 11 $\frac{3}{4}$ "



**Feine Pinzetten**  
**Delicate Forceps • Pinzas finas**  
**Pinces fines • Pinze delicate**

---



**6002.01**



**6002.05**

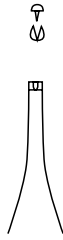

**6002.12**

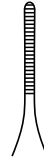

**6012.12**



12 cm – 4¾"  
**Hudson (Ewald)**

12 cm – 4¾"  
**Adson**



**6022.12**



**6032.12**

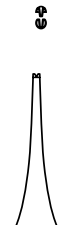

**6022.15**

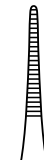

**6032.15**

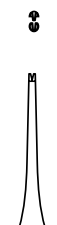

12 cm – 4¾"  
**Micro-Adson**

15 cm – 6"  
**Micro-Adson**

**Feine Pinzetten**  
**Delicate Forceps • Pinzas finas**  
**Pinces fines • Pinze delicate**



12 cm – 4<sup>3</sup>/<sub>4</sub>"  
**Adson-Brown**



**6052.12**

7 × 7 Zähne  
 7 × 7 teeth  
 7 × 7 dientes  
 7 × 7 dents  
 7 × 7 denti



**6052.15**

9 × 9 Zähne  
 9 × 9 teeth  
 9 × 9 dientes  
 9 × 9 dents  
 9 × 9 denti



**6004.15**  
 15 cm – 6"  
**McIndoe**



**6004.85**  
 15 cm – 6"  
**Gillies**



**Feine Pinzetten**  
**Delicate Forceps • Pinzas finas**  
**Pinces fines • Pinze delicate**

---



**6003.12**  
12,5 cm – 5"



**6003.15**  
15 cm – 6"



**6003.22**  
12,5 cm – 5"

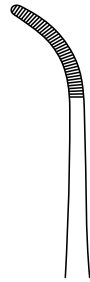

**6003.25**  
15 cm – 6"

**Semken**



**6013.12**  
12,5 cm – 5"

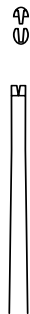

**6013.15**  
15 cm – 6"



**6013.22**  
12,5 cm – 5"



**6013.25**  
15 cm – 6"

**Semken**

**Anatomische / Chirurgische Pinzetten**  
**Dressing / Tissue Forceps • Pinzas anatómicas / quirúrgicas**  
**Pinces anatomiques / chirurgicales • Pinze anatomiche / chirurgiche**

---



**6064.18**  
18 cm – 7 $\frac{1}{8}$ "



**6064.20**  
20 cm – 8"



**6064.25**  
25 cm – 10"

**Potts-Smith**

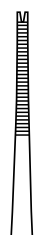

**6084.18**  
18 cm – 7 $\frac{1}{8}$ "

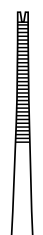

**6084.20**  
20 cm – 8"



**6084.25**  
25 cm – 10"

**Potts-Smith**



**Atraumatische Pinzetten**  
**Atraumatic Forceps • Pinzas atraumáticas**  
**Pinces atraumatiques • Pinze atraumatiche**

---



1,5 mm

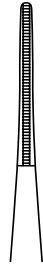

**6005.15**  
15 cm – 6"

1,5 mm

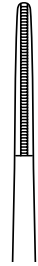

**6005.19**  
20 cm – 8"

1,5 mm

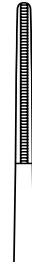

**6005.24**  
24 cm – 9½"

**DeBakey**



2 mm

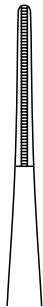

**6025.15**  
15 cm – 6"

2 mm



**6025.19**  
20 cm – 8"

2 mm



**6025.24**  
24 cm – 9½"

**DeBakey**



**Atraumatische Pinzetten**  
**Atraumatic Forceps • Pinzas atraumáticas**  
**Pinces atraumatiques • Pinze atraumatiche**

---



2,8 mm



**6045.15**  
15 cm – 6"

2,8 mm

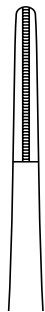

**6045.19**  
20 cm – 8"

2,8 mm

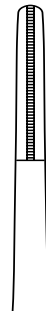

**6045.24**  
24 cm – 9½"

2,8 mm

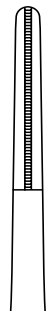

**6045.30**  
30 cm – 11¾"

**DeBakey**



3,5 mm

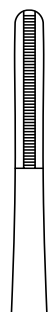

**6055.19**  
20 cm – 8"

3,5 mm



**6055.24**  
24 cm – 9½"

3,5 mm

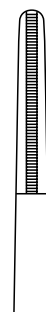

**6055.30**  
30 cm – 11¾"

**DeBakey**

**Anatomische / Chirurgische Pinzetten**  
**Dressing / Tissue Forceps • Pinzas anatómicas / quirúrgicas**  
**Pinces anatomiques / chirurgicales • Pinze anatomiche / chirurgiche**

---



**6006.17**



**6006.87**

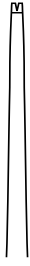

**6006.18**

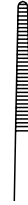

**6006.88**



18 cm – 7 1/8"  
**Cushing**

18 cm – 7 1/8"  
**Cushing**



**6006.90**



**6006.92**

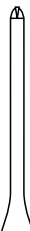

18 cm – 7 1/8"  
**Gerald**



**Gewebefaßpinzetten**  
**Tissue Grasping Forceps • Pinzas para coger tejido**  
**Pinces pour saisir les tissus • Pinze per afferrare tessuti**

---



**7051.15**  
15 cm – 6"



**7051.20**  
20 cm – 8"



**7051.25**  
25 cm – 10"

**Russ. Mod.**



**Bajonettpinzetten**  
**Bayonet Forceps • Pinzas en forma bayoneta**  
**Pinces forme baïonnette • Pinze a forma di baionetta**

---



**7003.14**  
14 cm – 5½"  
**Lucae**



**7003.16**  
16 cm – 6¼"

**Gruenwald**

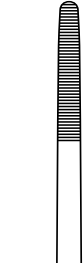

**7003.19**  
19 cm – 7½"



**7053.13**  
13 cm – 5⅛"  
**Troeltsch (Wilde)**

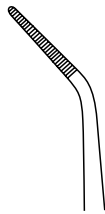

**23301.20**



**23301.22**

15 cm – 6"  
**London-College**

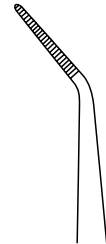

**23351.20**  
15 cm – 6"  
**London-College**

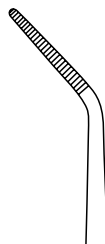

**23302.10**  
16 cm – 6¼"  
**Meriam**



**23302.20**  
16 cm – 6¼"  
**Meriam**



**Splitterpinzetten**  
**Splinter Forceps • Pinzas para espina**  
**Pinces à échardes • Pinze per schegge**

---



**7028.07**  
8 cm – 3 $\frac{1}{8}$ "



**7028.09**  
9,5 cm – 3 $\frac{3}{4}$ "

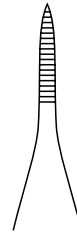

**7028.11**  
11,5 cm – 4 $\frac{1}{2}$ "

**Feilchenfeld**



**7048.11**



**7048.21**

11 cm – 4 $\frac{3}{8}$ "  
**Hunter**

**Splitterzangen**  
**Splinter Forceps • Pinzas para espina**  
**Pinces à échardes • Pinze per schegge**

---



**7019.14**  
14 cm – 5½"  
**Stieglitz (Williams)**



**7019.24**  
14 cm – 5½"  
**Stieglitz (Williams)**

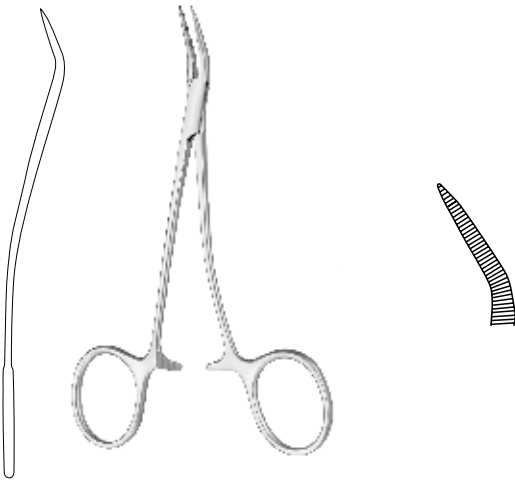

**7009.11**  
11,5 cm – 4½"  
**Peet**

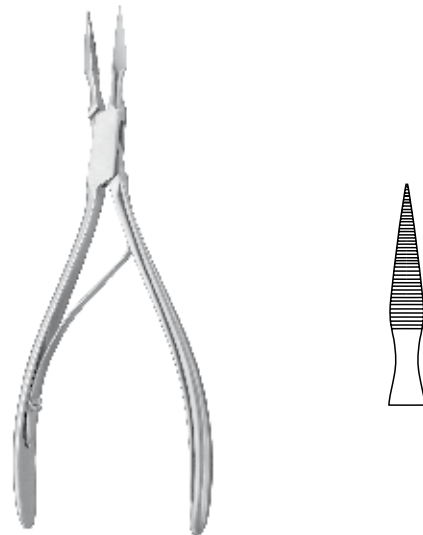

**7049.14**  
14 cm – 5½"  
**Ralk**





**Sauginstrumente**  
**Aspirating Instruments**  
**Instrumentos de aspiración**  
**Instruments à aspiration**  
**Strumenti per aspirazione**



**Sauginstrumente**  
**Aspirating Instruments • Instrumentos de aspiración**  
**Instruments à aspiration • Strumenti per aspirazione**

---



**9038.26** Charr. 6  
**9038.28** Charr. 8  
**9038.30** Charr. 10  
**9038.32** Charr. 12  
**Frazier (Fergusson)**



**Sauginstrumente**  
**Aspirating Instruments • Instrumentos de aspiración**  
**Instruments à aspiration • Strumenti per aspirazione**

---



**9058.00**  
28 cm – 11"  
**Yankauer**



**9078.30** Charr. 30  
22 cm – 8<sup>3</sup>/<sub>4</sub>"  
**Poole**



**9088.23** Charr. 23  
22 cm – 8<sup>3</sup>/<sub>4</sub>"  
**Poole**







**Nadelhalter**  
**Needle Holders**  
**Porta-agujas**  
**Porte-aiguilles**  
**Portaghi**



**Nadelhalter**  
**Needle Holders • Porta-agujas**  
**Porte-aiguilles • Portaghi**

---

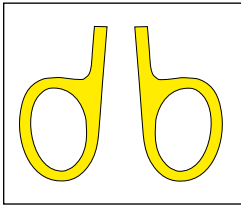

TC – Nadelhalter mit Hartmetalleinlagen  
TC – Needle Holders with Tungsten Carbide Inserts  
TC – Porta-agujas con insertos de tungsteno  
TC – Porte-aiguilles à mors en tungstène  
TC – Port'aghi con morsi rivestiti di placchette di metallo duro

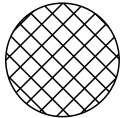

Normal            0,5 mm für Nahtmaterial bis Stärke 4-0  
Regular          0,5 mm for sutures up to size 4-0  
Normal          0,5 mm para material de suturar hasta el espesor de 4-0  
Normal          0,5 mm pour matériel à suture jusqu'à l'épaisseur de 4-0  
Normale        0,5 mm per materiale per sutura fino allo spessore 4-0

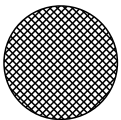

Fein                0,4 mm für Nahtmaterial Stärke 5-0 und 6-0  
Fine                0,4 mm for sutures sizes 5-0 and 6-0  
Fino                0,4 mm para material de suturar espesores 5-0 y 6-0  
Fin                 0,4 mm pour matériel à suture épaisseurs 5-0 et 6-0  
Fine                0,4 mm per materiale per sutura di spessore 5-0 e 6-0

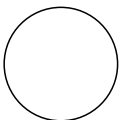

Glatt                für Nahtmaterial Stärke 7-0 bis 10-0  
Smooth            for sutures sizes 7-0 and 10-0  
Liso                 para material de suturar espesores 7-0 y 10-0  
Lisse                pour matériel à suture épaisseurs 7-0 et 10-0  
Lisico               per sutura spessore 7-0 e 10-0

**Nadelhalter**  
**Needle Holders • Porta-agujas**  
**Porte-aiguilles • Portaghi**

---

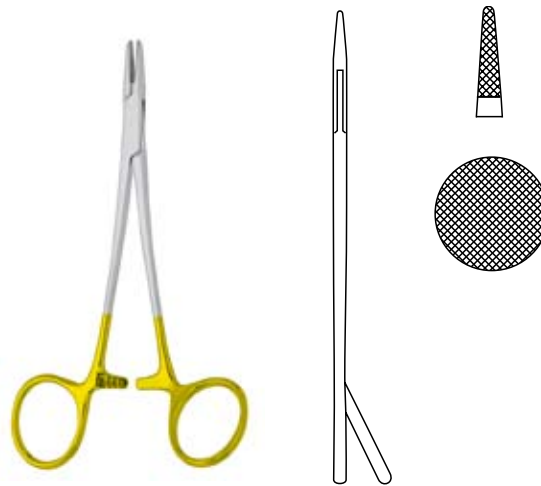

**0180.62**  
12,5 cm – 5"  
**Neivert "TC"**

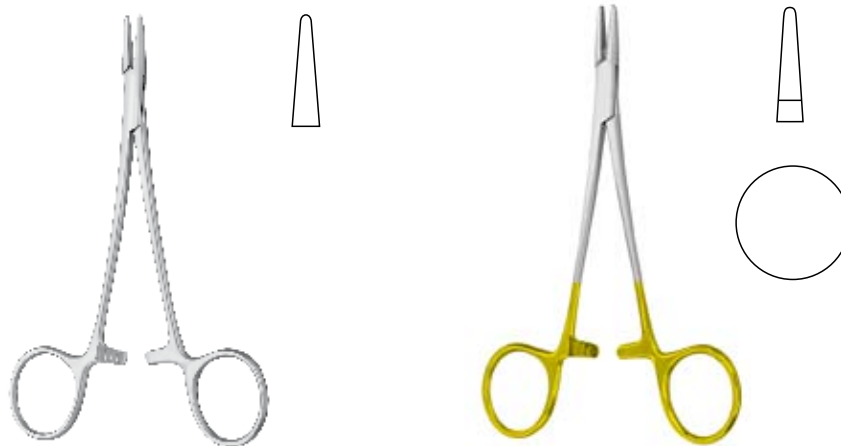

**0101.12**  
12,5 cm – 5"  
**Webster**

**0101.62**  
12,5 cm – 5"  
**Webster "TC"**

**Nadelhalter**  
**Needle Holders • Porta-agujas**  
**Porte-aiguilles • Portaghi**

---



**0101.13**  
13,5 cm – 5<sup>3</sup>/<sub>8</sub>"  
**Halsey**

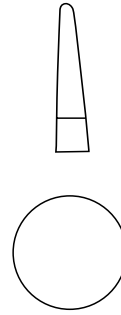

**0101.63**  
13,5 cm – 5<sup>3</sup>/<sub>8</sub>"  
**Halsey "TC"**

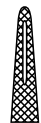

**0121.12**  
12,5 cm – 5"  
**Wright (Derf)**

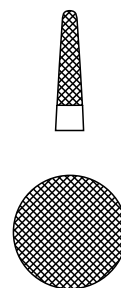

**0121.62**  
12,5 cm – 5"  
**Wright (Derf) "TC"**

**Nadelhalter**  
**Needle Holders • Porta-agujas**  
**Porte-aiguilles • Portaghi**

---



**0121.13**  
13,5 cm – 5<sup>3</sup>/<sub>8</sub>"  
**Halsey**

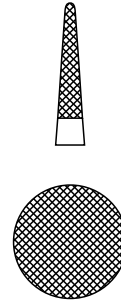

**0121.63**  
13,5 cm – 5<sup>3</sup>/<sub>8</sub>"  
**Halsey "TC"**



**0141.14**  
14 cm – 5<sup>1</sup>/<sub>2</sub>"  
**Baumgartner**

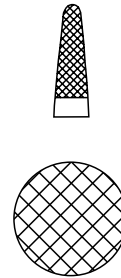

**0141.64**  
14 cm – 5<sup>1</sup>/<sub>2</sub>"  
**Baumgartner "TC"**

**Nadelhalter**  
**Needle Holders • Porta-agujas**  
**Porte-aiguilles • Portaghi**

---



**Mayo-Hegar**

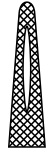

**0181.15**  
16 cm – 6¼"



**0181.18**  
18 cm – 7⅛"



**0181.20**  
20 cm – 8"



**0181.24**  
24 cm – 9½"



**Mayo-Hegar "TC"**



**0181.65**  
16 cm – 6¼"



**0181.68**  
18 cm – 7⅛"



**0181.70**  
20 cm – 8"



**0181.74**  
24 cm – 9½"

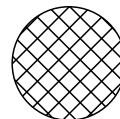

**Nadelhalter**  
**Needle Holders • Porta-agujas**  
**Porte-aiguilles • Portaghi**

---



**0102.14**  
15 cm – 6"  
**Baby Crile-Wood**



**Crile-Wood**



**0102.15**  
15 cm – 6"



**0102.18**  
18 cm – 7 $\frac{1}{8}$ "



**0102.20**  
20 cm – 8"



**Nadelhalter**  
**Needle Holders • Porta-agujas**  
**Porte-aiguilles • Portaghi**

---

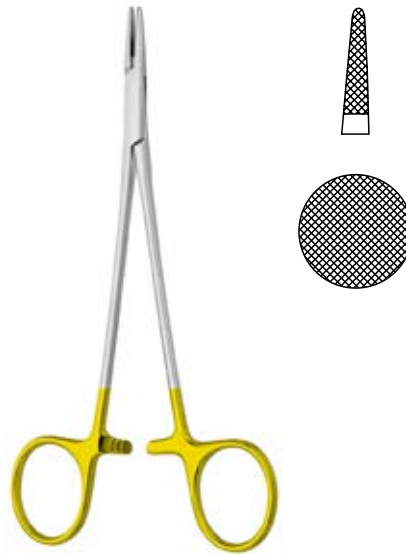

**0102.64**  
15 cm – 6"  
**Baby Crile-Wood "TC"**



**Crile-Wood "TC"**



**0102.65**  
15 cm – 6"



**0102.68**  
18 cm – 7 1/8"



**0102.70**  
20 cm – 8"



**0102.73**  
23 cm – 9"

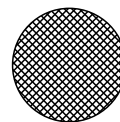

**Nadelhalter**  
**Needle Holders • Porta-agujas**  
**Porte-aiguilles • Portaghi**

---



**0106.14**  
14 cm – 5½"



**0106.17**  
17 cm – 6¾"

**Olsen-Hegar**



**0106.64**  
14 cm – 5½"



**0106.67**  
17 cm – 6¾"

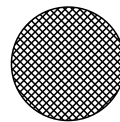

**Olsen-Hegar "TC"**

**Nadelhalter**  
**Needle Holders • Porta-agujas**  
**Porte-aiguilles • Portaghi**

---



**Mathieu**



**1102.14**  
14 cm – 5½"



**1102.17**  
14 cm – 6¾"



**1102.20**  
20 cm – 8"



**Mathieu "TC"**



**1102.64**  
14 cm – 5½"



**1102.67**  
17 cm – 6¾"



**1102.70**  
20 cm – 8"

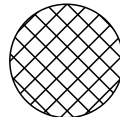



**Wundklammerinstrumente**  
**Clip Applying Instruments • Instrumentos para poner agrafes**  
**Instruments pour poser les agrafes • Strumenti per applicare i fermagli**

---

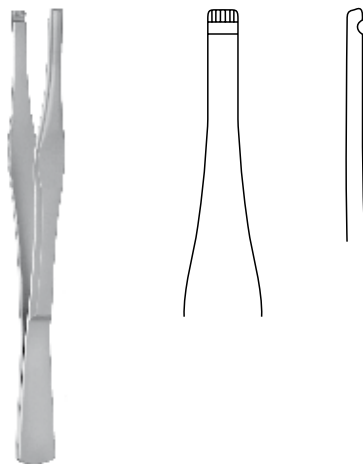

**3157.12**  
12,5 cm – 5"  
**Michel**

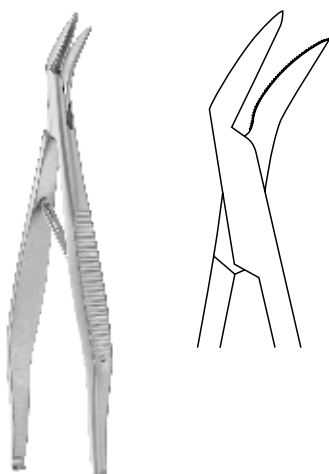

**3187.12**  
12 cm – 4¾"  
**Michel**



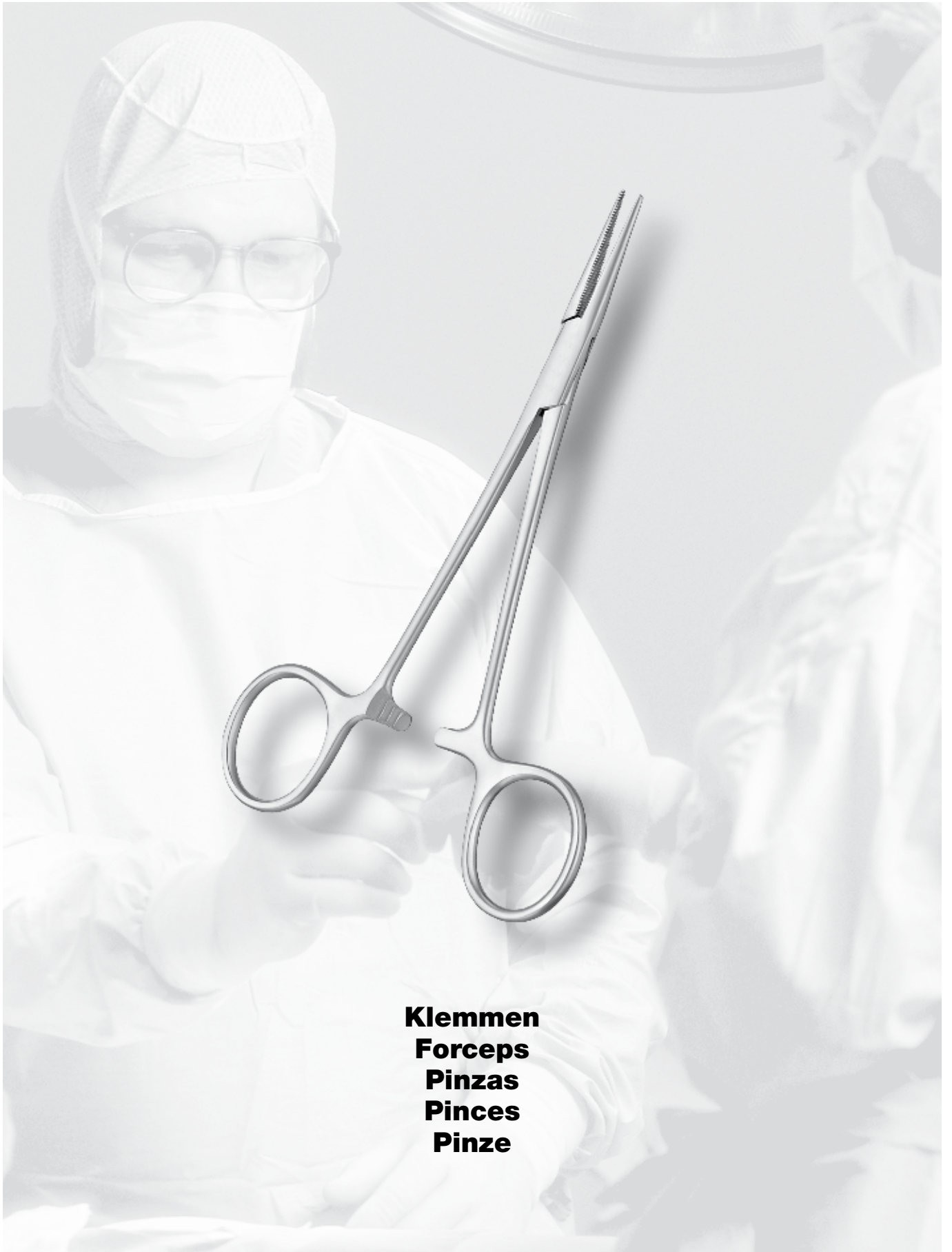

**Klemmen**  
**Forceps**  
**Pinzas**  
**Pinces**  
**Pinze**

**Arterienklemmen**  
**Hemostatic Forceps • Pinzas hemostáticas**  
**Pinces hémostatiques • Pinze emostatiche**

---



9 cm – 3½"  
**Micro-Hartmann**



**5103.09**



**5113.09**



**5103.79**



**5113.79**



12,5 cm – 5"  
**Micro-Halsted**



**5104.12**



**5114.12**



**5124.12**

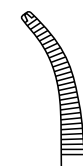

**5134.12**

**Arterienklemmen**  
**Hemostatic Forceps • Pinzas hemostáticas**  
**Pinces hémostatiques • Pinze emostatiche**

---



9 cm – 3½"  
**Hartmann**  
**(Baby-Mosquito)**



**5123.09**



**5133.09**



14 cm – 5½"  
**Pean-Baby**



**5182.14**

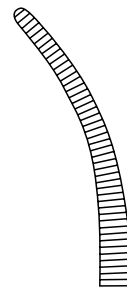

**5192.14**



**Arterienklemmen**  
**Hemostatic Forceps • Pinzas hemostáticas**  
**Pinces hémostatiques • Pinze emostatiche**

---



12,5 cm – 5"  
**Halsted-Mosquito**



**5144.12**



**5154.12**

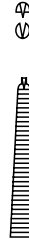

**5164.12**

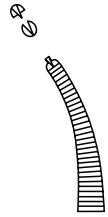

**5174.12**



14 cm – 5½"  
**Halsted-Mosquito**



**5144.14**



**5154.14**

**Arterienklemmen**  
**Hemostatic Forceps • Pinzas hemostáticas**  
**Pinces hémostatiques • Pinze emostatiche**



15 cm – 6"  
**Leriche**



**5165.15**



**5175.15**



**5185.15**

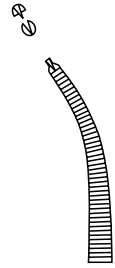

**5195.15**



**6160.14** 14 cm – 5½"  
**6160.16** 16 cm – 6¼"  
**Pean**



**Arterienklemmen**  
**Hemostatic Forceps • Pinzas hemostáticas**  
**Pinces hémostatiques • Pinze emostatiche**

---



14 cm – 5½"  
**Kelly**



**5107.14**



**5117.14**



16 cm – 6¼"  
**Rankin-Kelly**



**5107.16**

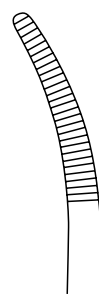

**5117.16**

**Arterienklemmen**  
**Hemostatic Forceps • Pinzas hemostáticas**  
**Pinces hémostatiques • Pinze emostatiche**

---



14 cm – 5½"  
**Crile**



**5127.14**



**5137.14**



16 cm – 6¼"  
**Crile-Rankin**



**5127.16**

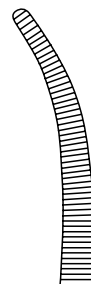

**5137.16**



**Arterienklemmen**  
**Hemostatic Forceps • Pinzas hemostáticas**  
**Pinces hémostatiques • Pinze emostatiche**

---



**Spencer-Wells**



**5167.13**  
13 cm – 5 $\frac{1}{8}$ "



**5167.14**  
14 cm – 5 $\frac{1}{2}$ "



**5167.16**  
16 cm – 6 $\frac{1}{4}$ "

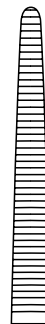

**5167.18**  
18 cm – 7 $\frac{1}{8}$ "



**5167.20**  
20 cm – 8"



**Arterienklemmen**  
**Hemostatic Forceps • Pinzas hemostáticas**  
**Pinces hémostatiques • Pinze emostatiche**

---



**Spencer-Wells**



**5177.13**  
13 cm – 5 $\frac{1}{8}$ "



**5177.14**  
14 cm – 5 $\frac{1}{2}$ "

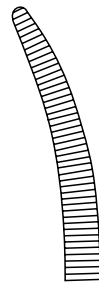

**5177.16**  
16 cm – 6 $\frac{1}{4}$ "



**5177.18**  
18 cm – 7 $\frac{1}{8}$ "

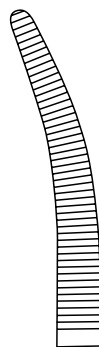

**5177.20**  
20 cm – 8"

**Arterienklemmen**  
**Hemostatic Forceps • Pinzas hemostáticas**  
**Pinces hémostatiques • Pinze emostatiche**

---



**Rochester-Pean**



**6101.16**  
16 cm – 6¼"



**6101.18**  
18 cm – 7⅛"



**6101.20**  
20 cm – 8"



**6101.22**  
22 cm – 8¾"



**6101.24**  
24 cm – 9½"



**6101.26**  
26 cm – 10¼"



**Arterienklemmen**  
**Hemostatic Forceps • Pinzas hemostáticas**  
**Pinces hémostatiques • Pinze emostatiche**

---

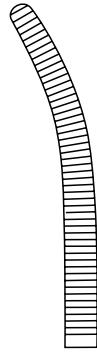

**6111.16**  
16 cm – 6¼"

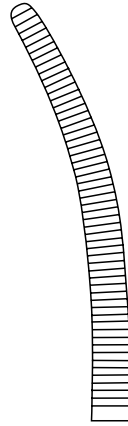

**6111.18**  
18 cm – 7⅛"

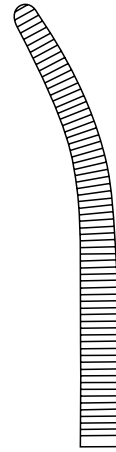

**6111.20**  
20 cm – 8"



**Rochester-Pean**

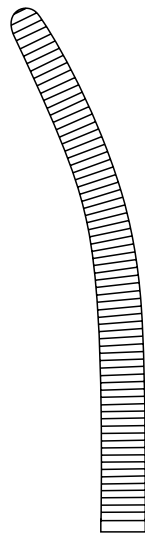

**6111.22**  
22 cm – 8¾"

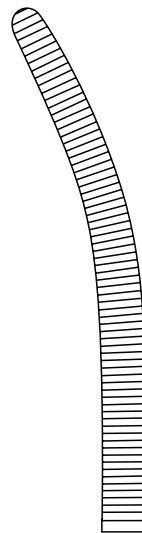

**6111.24**  
24 cm – 9½"

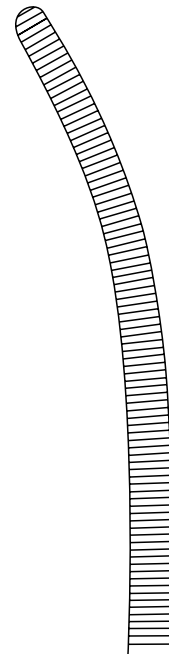

**6111.26**  
26 cm – 10¼"



**Arterienklemmen**  
**Hemostatic Forceps • Pinzas hemostáticas**  
**Pinces hémostatiques • Pinze emostatiche**

---



**Pean**



**6101.13**  
13 cm – 5 $\frac{1}{8}$ "



**6101.14**  
14 cm – 5 $\frac{1}{2}$ "



**6111.13**  
13 cm – 5 $\frac{1}{8}$ "

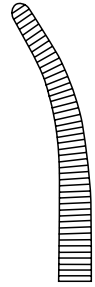

**6111.14**  
14 cm – 5 $\frac{1}{2}$ "



14 cm – 5 $\frac{1}{2}$ "  
**Kocher**



**6121.14**

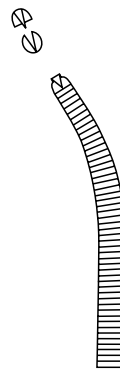

**6131.14**

**Arterienklemmen**  
**Hemostatic Forceps • Pinzas hemostáticas**  
**Pinces hémostatiques • Pinze emostatiche**

---



14 cm – 5½”  
**Dandy**

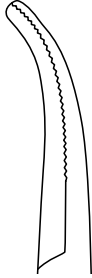

**6111.84**



**6111.94**



16 cm – 6¼”  
**Pean-Dixon**



**6101.86**

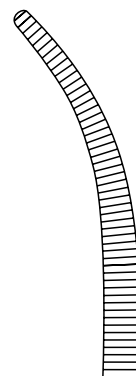

**6111.86**

**Arterienklemmen**  
**Hemostatic Forceps • Pinzas hemostáticas**  
**Pinces hémostatiques • Pinze emostatiche**



**Rochester-Ochsner**



**6121.16**  
16 cm – 6¼"



**6121.18**  
18 cm – 7⅛"



**6121.20**  
20 cm – 8"



**6121.22**  
22 cm – 8¾"



**6121.24**  
24 cm – 9½"



**6121.26**  
26 cm – 10¼"

**Arterienklemmen**  
**Hemostatic Forceps • Pinzas hemostáticas**  
**Pinces hémostatiques • Pinze emostatiche**

---

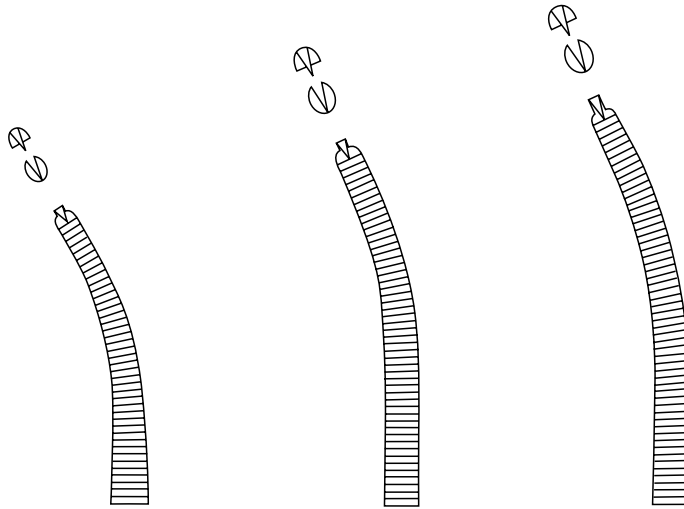

**6131.16**  
16 cm – 6¼"

**6131.18**  
18 cm – 7⅛"

**6131.20**  
20 cm – 8"



**Rochester-Ochsner**

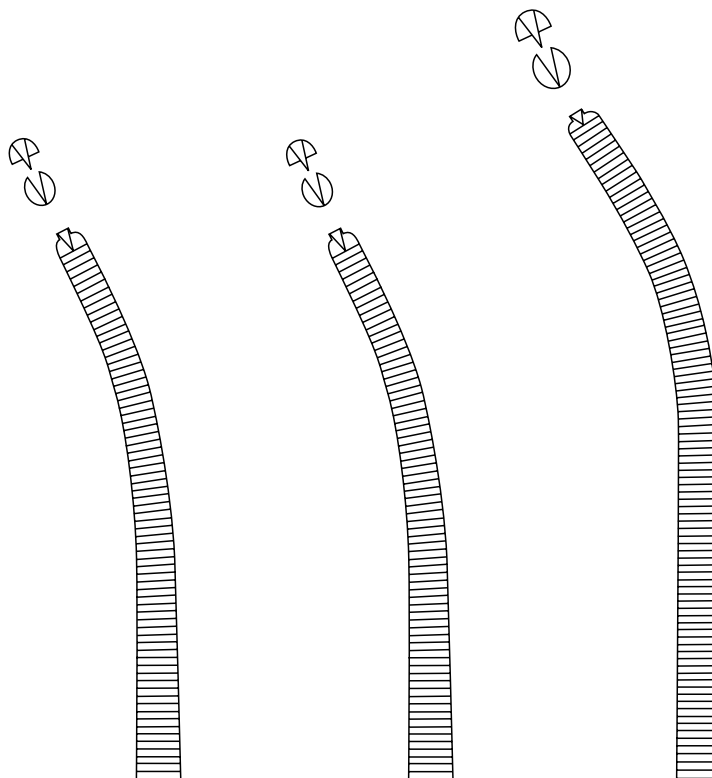

**6131.22**  
22 cm – 8¾"

**6131.24**  
24 cm – 9½"

**6131.26**  
26 cm – 10¼"

**Arterienklemmen**  
**Hemostatic Forceps • Pinzas hemostáticas**  
**Pinces hémostatiques • Pinze emostatiche**

---



**Heiss**

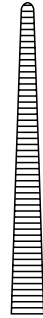

**6105.20**  
21 cm – 8¼"

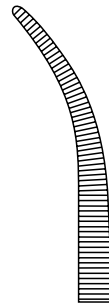

**6115.20**  
21 cm – 8¼"

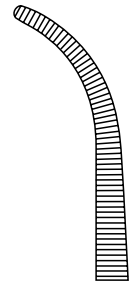

**6115.21**  
20 cm – 8"



18 cm – 7⅛"  
**Halsted (Adson)**



**6104.18**



**6114.18**

**Arterienklemmen**  
**Hemostatic Forceps • Pinzas hemostáticas**  
**Pinces hémostatiques • Pinze emostatiche**

---



22 cm – 8<sup>3</sup>/<sub>4</sub>"  
**Roberts**



**6141.72**

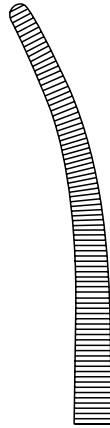

**6151.72**



**6174.19**  
19 cm – 7<sup>1</sup>/<sub>2</sub>"  
**Birkett**

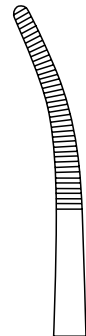

**Arterienklemmen**  
**Hemostatic Forceps • Pinzas hemostáticas**  
**Pinces hémostatiques • Pinze emostatiche**

---



**Bengolea**



**6165.20**  
20 cm – 8"



**6175.20**  
20 cm – 8"

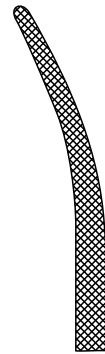

**6175.26**  
26 cm – 10¼"



**6185.20**  
20 cm – 8"

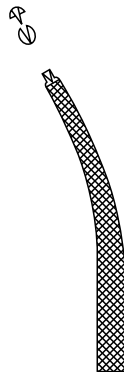

**6195.20**  
20 cm – 8"



**6195.26**  
26 cm – 10¼"

**Präparier- und Ligaturklemmen**  
**Dissecting and Ligature Forceps • Pinzas para preparaciones y ligaduras**  
**Pinces à préparations et à ligatures • Pinze per preparazione e per legatura**

---



**Overholt**

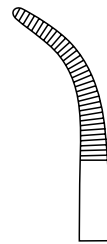
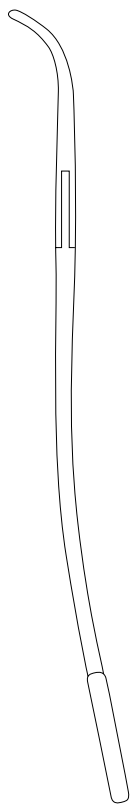

**6146.18**  
18,5 cm – 7¼"

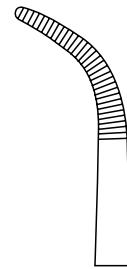

**6146.20**  
20,5 cm – 8"

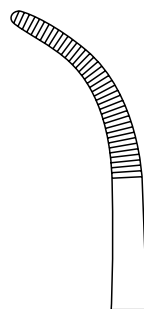

**6146.21**  
21 cm – 8¼"

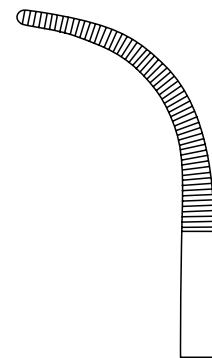

**6146.22**  
21,5 cm – 8½"



**Präparier- und Ligaturklemmen**  
**Dissecting and Ligature Forceps • Pinzas para preparaciones y ligaduras**  
**Pinces à préparations et à ligatures • Pinze per preparazione e per legatura**

---

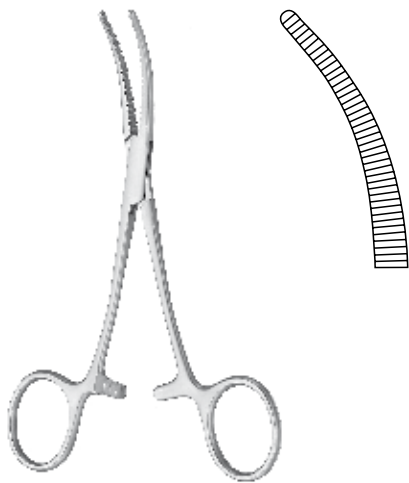

**6156.13**  
13,5 cm – 5<sup>3</sup>/<sub>4</sub>"  
**Baby-Overholt**



**7111.19**  
19 cm – 7<sup>1</sup>/<sub>2</sub>"  
**Lahey**

**Präparier- und Ligaturklemmen**  
**Dissecting and Ligature Forceps • Pinzas para preparaciones y ligaduras**  
**Pinces à préparations et à ligatures • Pinze per preparazione e per legatura**



**Overholt-Geissendoerfer**

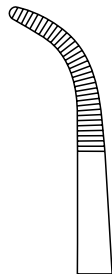

**6156.19**  
19 cm – 7½"

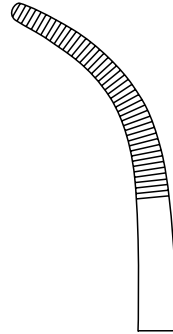

**6156.21**  
21,5 cm – 8½"

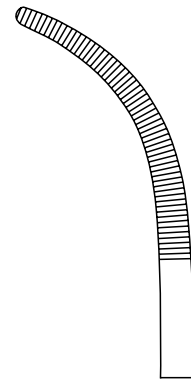

**6156.22**  
22,5 cm – 9"

**6156.27**  
27 cm – 10¾"

**6156.28**  
28 cm – 11"

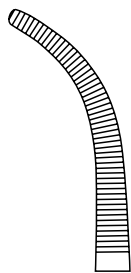

**6156.70**  
20,5 cm – 8"

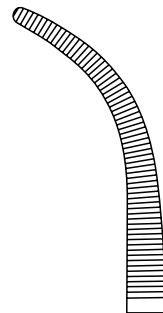

**6156.71**  
21 cm – 8¼"

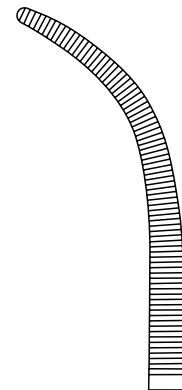

**6156.72**  
22,5 cm – 9"

**6156.76**  
26 cm – 10¼"

**6156.77**  
27 cm – 10¾"

**6156.78**  
27,5 cm – 10¾"

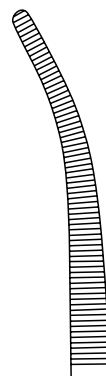

**6156.73**  
23,5 cm – 9¼"

**Präparier- und Ligaturklemmen**  
**Dissecting and Ligature Forceps • Pinzas para preparaciones y ligaduras**  
**Pinces à préparations et à ligatures • Pinze per preparazione e per legatura**

---



**Adson-Baby**



**7150.14**  
14 cm – 5½"

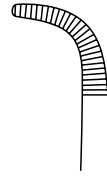

**7150.19**  
19 cm – 7½"



**Mixter-Baby**

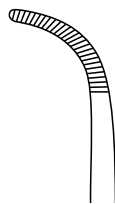

**7160.14**  
14 cm – 5½"

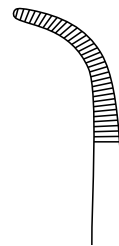

**7160.19**  
19 cm – 7½"

**Präparier- und Ligaturklemmen**  
**Dissecting and Ligature Forceps • Pinzas para preparaciones y ligaduras**  
**Pinces à préparations et à ligatures • Pinze per preparazione e per legatura**

---



**Mixer**

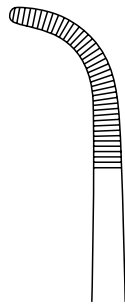

**7170.18**  
18 cm – 7 1/8"

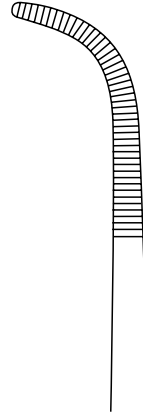

**7170.23**  
23 cm – 9"



**Gemini**

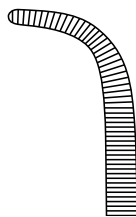

**7180.14**  
14 cm – 5 1/2"

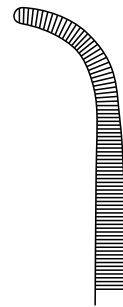

**7180.18**  
18 cm – 7 1/8"

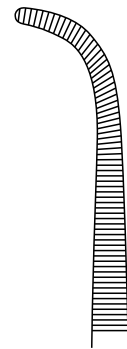

**7180.23**  
23 cm – 9"

**Arterien- und Tonsillenklemmen**  
**Hemostatic and Tonsil Forceps • Pinzas hemostáticas y tonsilares**  
**Pinces hémostatiques et amygdaliennes • Pinze emostatiche e tonsillari**

---



19 cm – 7½"  
**Schnidt (Boettcher)**



**7112.50**

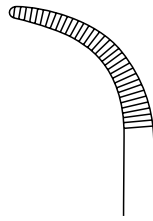

**7112.55**



19 cm – 7½"  
**Schnidt (Sawtell)**



**7112.51**

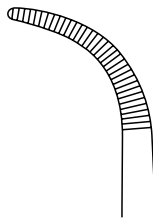

**7112.56**

**Arterien- und Gewebefäßklemmen**  
**Hemostatic and Tissue Grasping Forceps • Pinzas hemostáticas y para coger tejido**  
**Pinces hémostatiques pour saisir les tissus • Pinze per afferrare arterie e tessuti**



**7103.14**  
 14 cm – 5½”  
**Chaput**

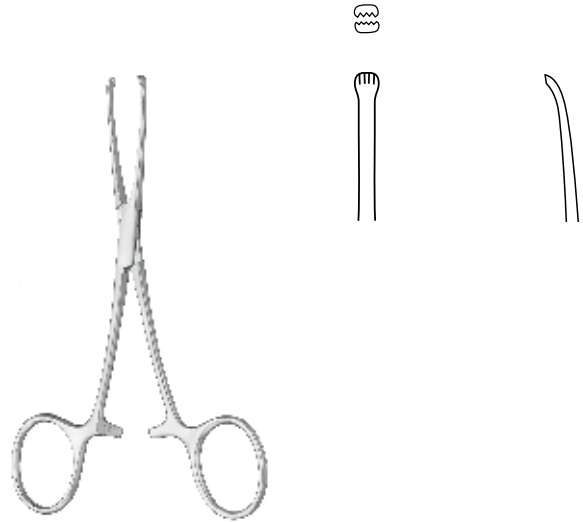
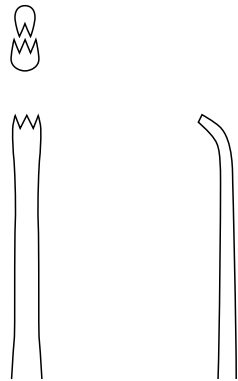

**7103.15**  
 13 cm – 5⅛”  
**Tuffier**

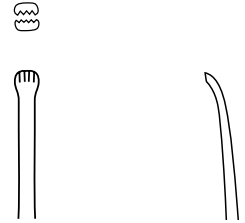

**7123.16**  
 16 cm – 6¼”  
**Collin**

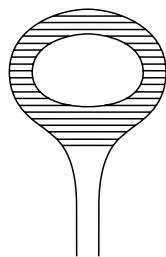

**7143.15**      **7143.20**  
 15 cm – 6”      20 cm – 8”  
**Pennington**

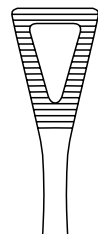

**Tuchklemmen**  
**Towel Clamps • Pinzas de campo**  
**Pinces à champs • Pinze fissatele**

---



**7105.18**  
 8 cm – 3 1/8" **Schaedel**



**7155.08** 8,5 cm – 3 3/8"  
**7155.10** 10,5 cm – 4 1/8"  
**7155.13** 13 cm – 5 1/8"  
**7155.15** 15 cm – 6" **Backhaus**



**Edna (Lorna)**

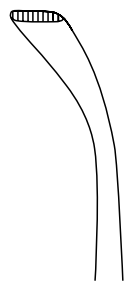

**7175.10**  
 10 cm – 4"

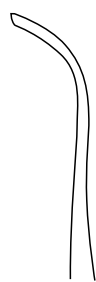

**7175.14**  
 14 cm – 5 1/2"



**Schlauchklemmen**  
**Tubing Clamps • Pinzas cierra-tubos**  
**Pinces presse-tube • Pinze serratubi**

---



**7127.75**  
15,5 cm – 6 $\frac{1}{8}$ "

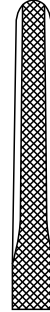

**7127.78**  
18 cm – 7 $\frac{1}{8}$ "

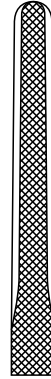

**7127.80**  
20 cm – 8"



**7127.76**  
15,5 cm – 6 $\frac{1}{8}$ "

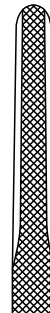

**7127.79**  
18 cm – 7 $\frac{1}{8}$ "

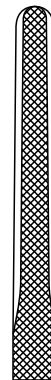

**7127.81**  
20 cm – 8"





**Schlauchklemmen**  
**Tubing Clamps • Pinzas cierra-tubos**  
**Pinces presse-tube • Pinze serratubi**

---



**Presbyterian-Hospital**



**7127.16**  
16 cm – 6¼"



**7127.18**  
18 cm – 7⅛"

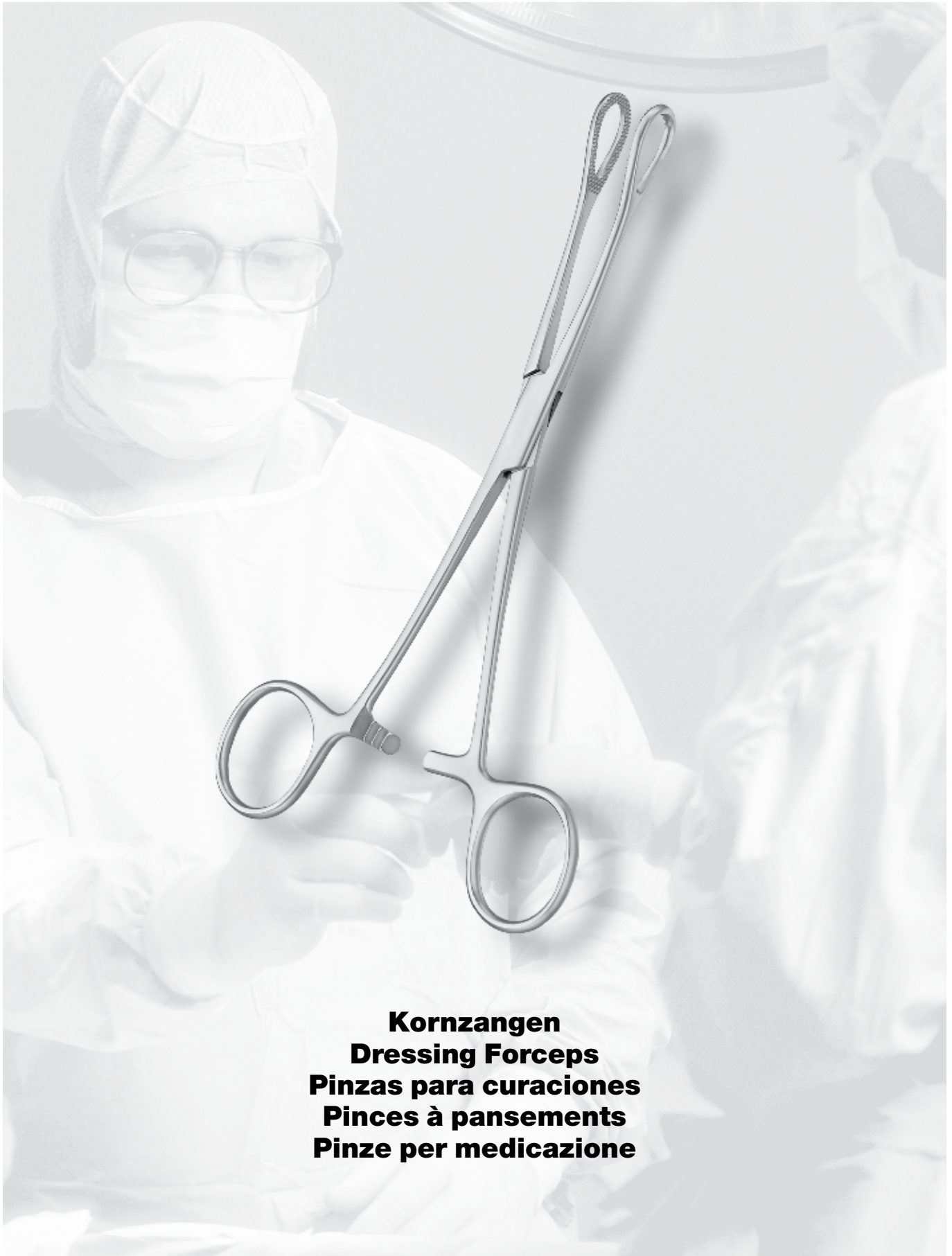

**Kornzangen**  
**Dressing Forceps**  
**Pinzas para curaciones**  
**Pinces à pansements**  
**Pinze per medicazione**

**Kornzangen**  
**Dressing Forceps • Pinzas para curaciones**  
**Pinces à pansements • Pinze per medicazione**



**9160.13**  
 13 cm – 5 1/8"



**9160.15**  
 15 cm – 6"

**Lister**



**9141.20**

20 cm – 8"  
**Gross**

**9151.20**

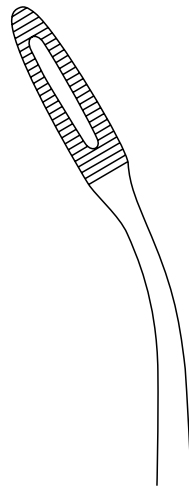

**9141.26**

26 cm – 10 1/4"  
**Maier**

**9151.26**

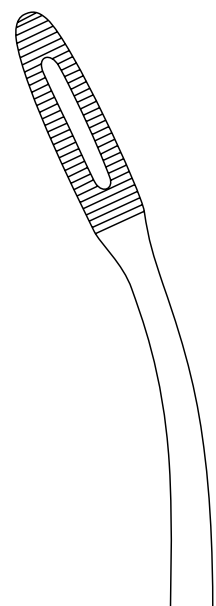

**Kornzangen**  
**Dressing Forceps • Pinzas para curaciones**  
**Pinces à pansements • Pinze per medicazione**

---



**9161.20**

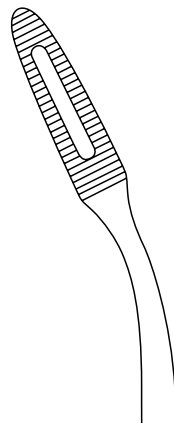

**9171.20**

20 cm – 8"  
**Gross**



**9161.26**

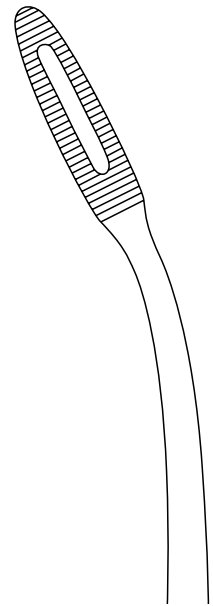

**9171.26**

26 cm – 10¼"  
**Maier**

**Schwammzangen**  
**Sponge Forceps • Pinzas porta-esponjas**  
**Pinces à pansements • Pinze per spugne**

---



18 cm – 7 $\frac{1}{8}$ "  
**Foerster (Ballenger)**

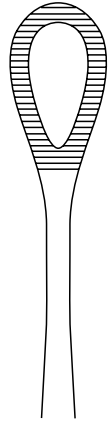

**9105.18**

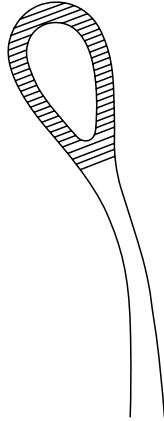

**9115.18**



24 cm – 9 $\frac{1}{2}$ "  
**Foerster**

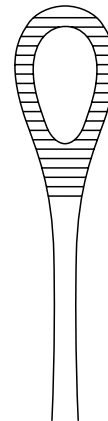

**9105.24**

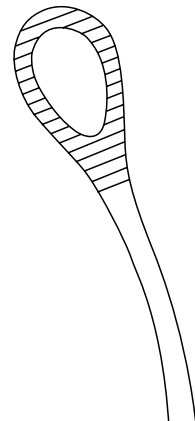

**9115.24**



**Schwammzangen**  
**Sponge Forceps • Pinzas porta-esponjas**  
**Pinces à pansements • Pinze per spugne**

---



24 cm – 9½"  
**Foerster**

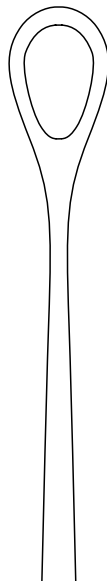

**9125.24**

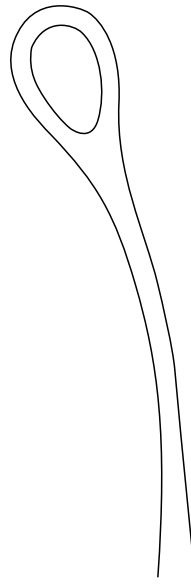

**9135.24**

**Tamponzangen**  
**Dressing Forceps • Pinzas para taponamiento**  
**Pinces porte-tampons • Pinze per tamponamento**

---



**9108.26**  
26 cm – 10¼"  
**Bozemann**



**9118.26**  
26 cm – 10¼"  
**Bozemann**

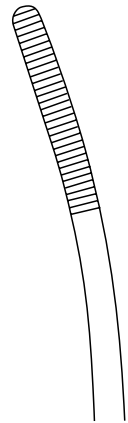
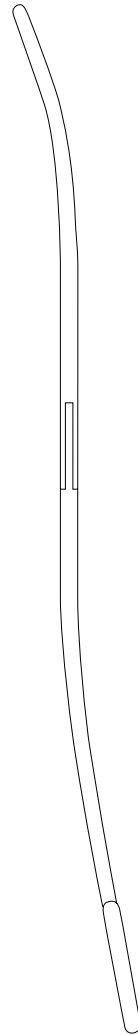



**Tamponzangen**  
**Dressing Forceps • Pinzas para taponamiento**  
**Pinces porte-tampons • Pinze per tamponamento**

---

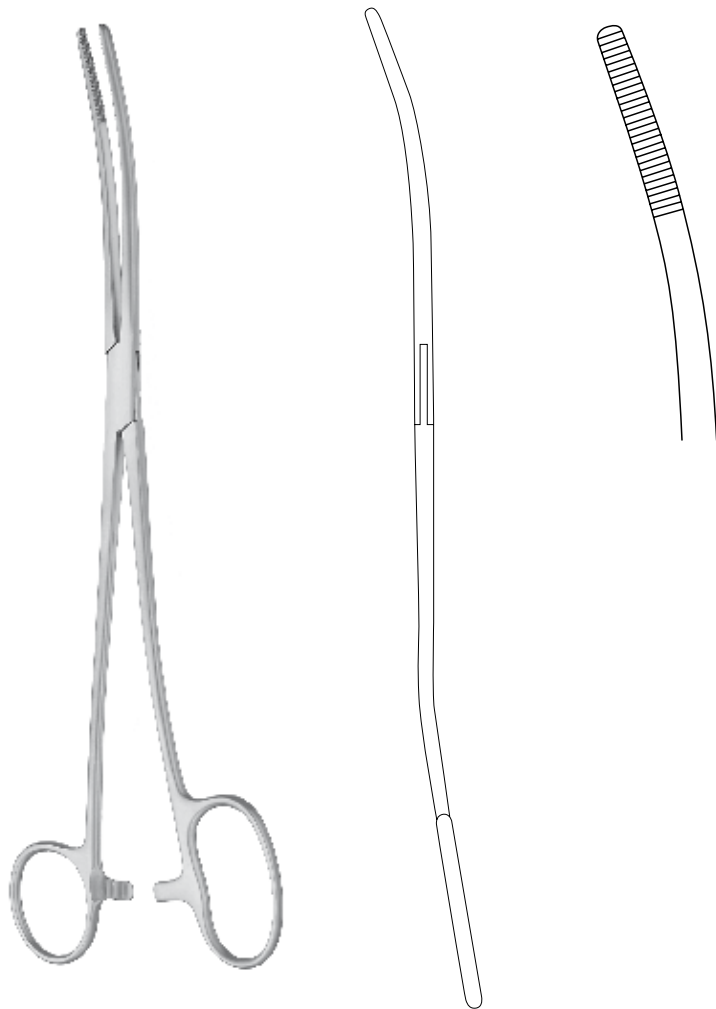

**9128.26**  
26 cm – 10 $\frac{1}{4}$ "  
**Bozemann-Douglas**





**bob**  
instruments

best of basic instruments

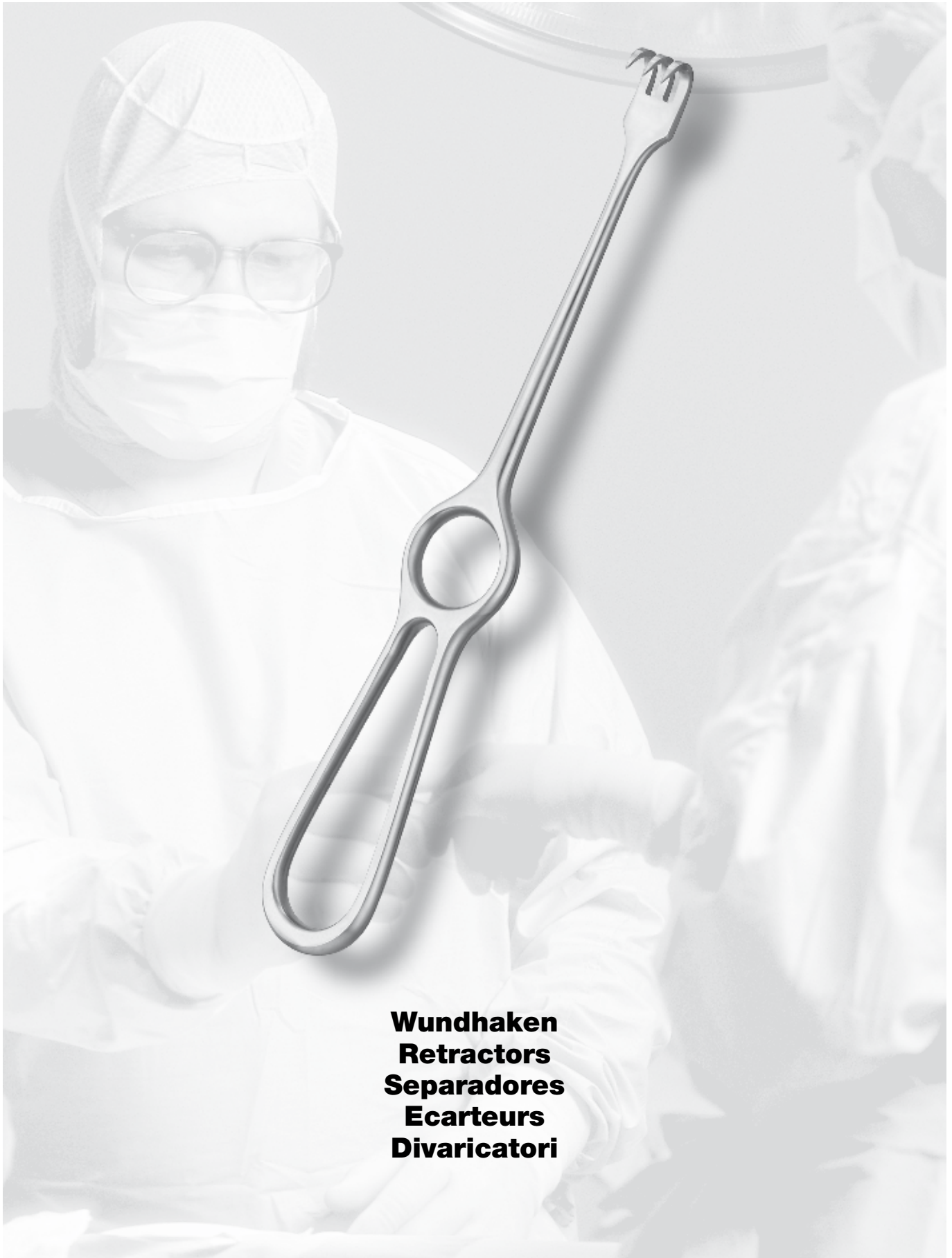

**Wundhaken**  
**Retractors**  
**Separadores**  
**Ecarteurs**  
**Divaricatori**

**Wundhaken, doppelendig**  
**Retractors double-ended • Separadores doble**  
**Ecarteurs doubles • Divaricatori doppi**

---

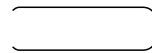
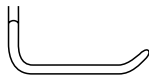
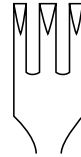
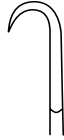

**0250.08**  
16 cm – 6¼"  
**Senn-Miller**

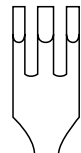
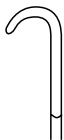

**0250.09**  
16 cm – 6¼"  
**Senn-Miller**



**Dura- und Hauthäkchen**  
**Dura and Skin Hooks • Ganchitos para dura-madre y piel**  
**Crochets dermatologiques et à dure-mère • Uncini per duramadre e per uso dermatologico**

---

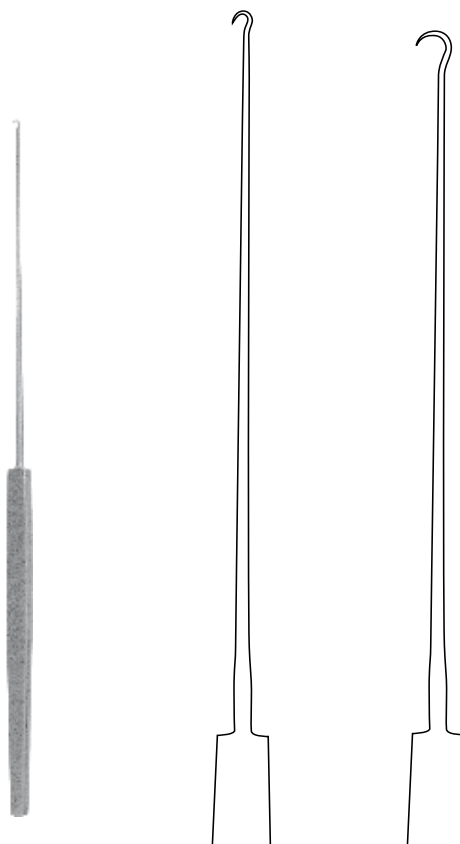

19 cm – 7½"  
**Gillies**

**0203.19**

**0203.20**



**Wund- und Hauthäkchen**  
**Retractors and Skin Hooks • Separadores y Ganchitos para piel**  
**Crochets dermatologiques et à plaie • Divaricatori e uncini dermatologici**

---



**0205.01**  
16 cm – 6¼"  
**Joseph**

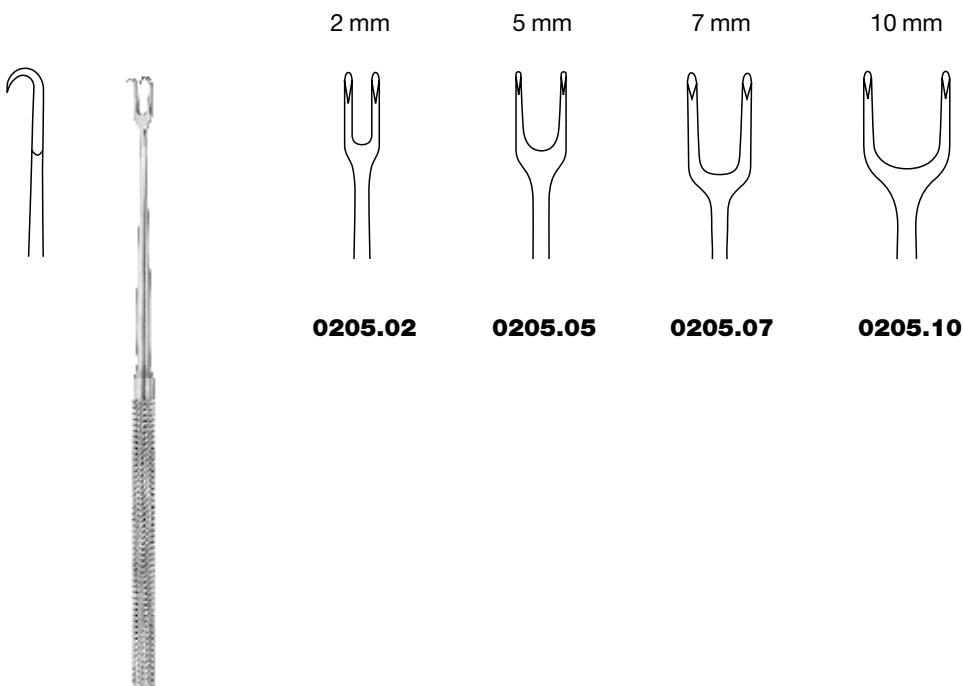

2 mm

5 mm

7 mm

10 mm

**0205.02**

**0205.05**

**0205.07**

**0205.10**

16 cm – 6¼"  
**Joseph**



**Wund- und Trachealhaken**  
**Wound and Tracheal Retractors • Separadores y Ganchos traqueales**  
**Ecarteurs fins et Crochets trachéaux • Divaricatori e uncini tracheali**

---

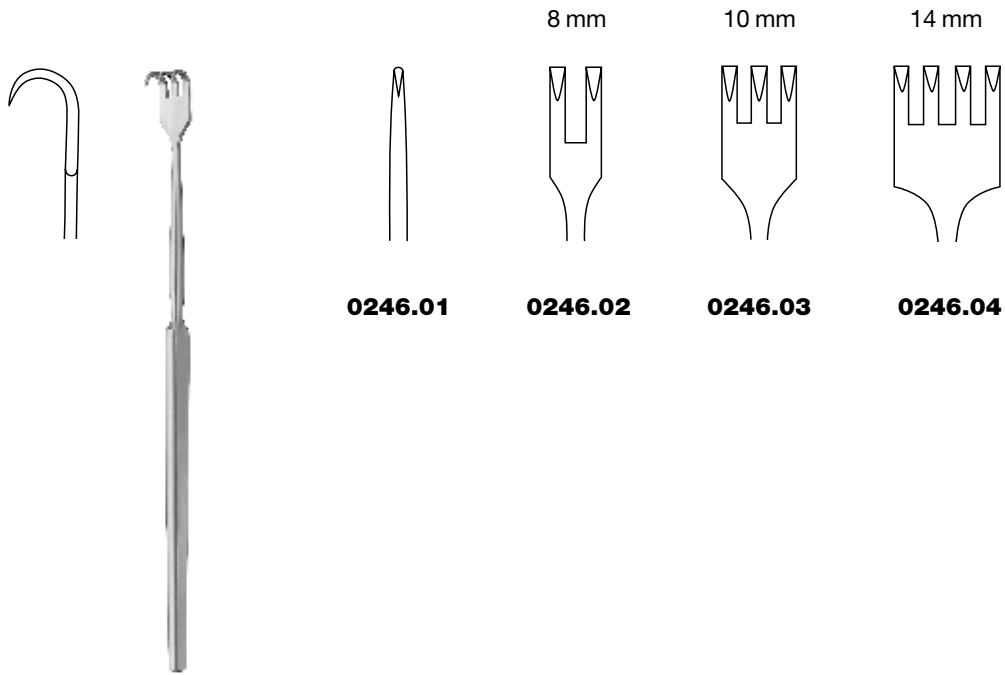

16 cm – 6¼"

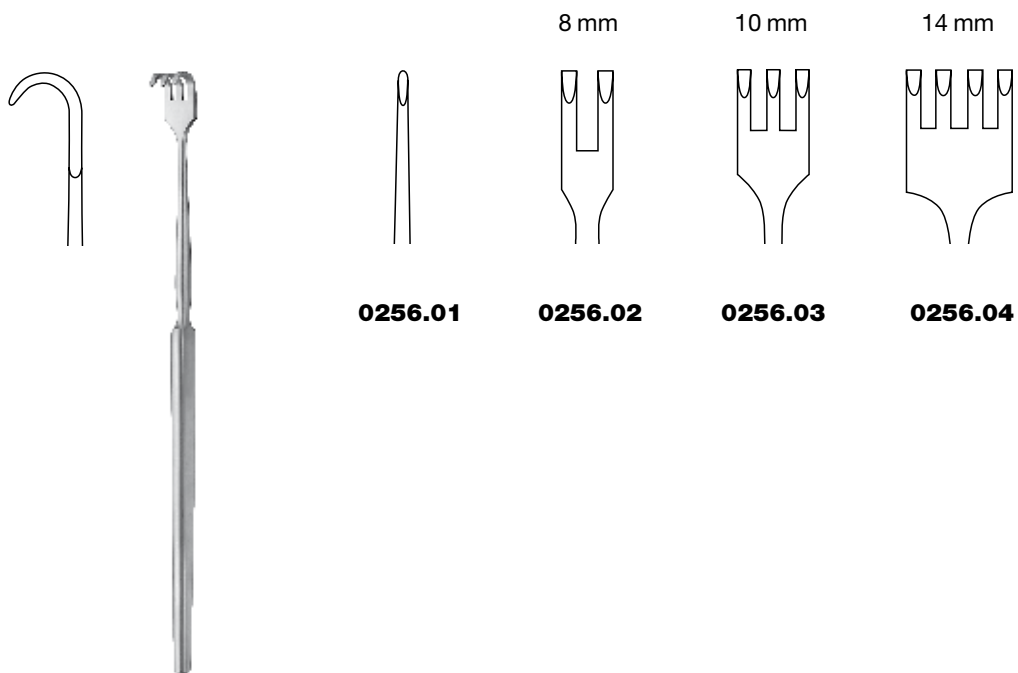

16 cm – 6¼"



**Wundhaken, doppelendig**  
**Retractors double-ended • Separadores doble extremo**  
**Ecarteurs doubles • Divaricatori doppi**

---



**2201.12**  
12 cm – 4¾"  
**Farabeuf-Baby**

**2201.15**  
15 cm – 6"  
**Farabeuf**



**Wundhaken, doppelendig**  
**Retractors double-ended • Separadores doble extremo**  
**Ecarteurs doubles • Divaricatori doppi**

---

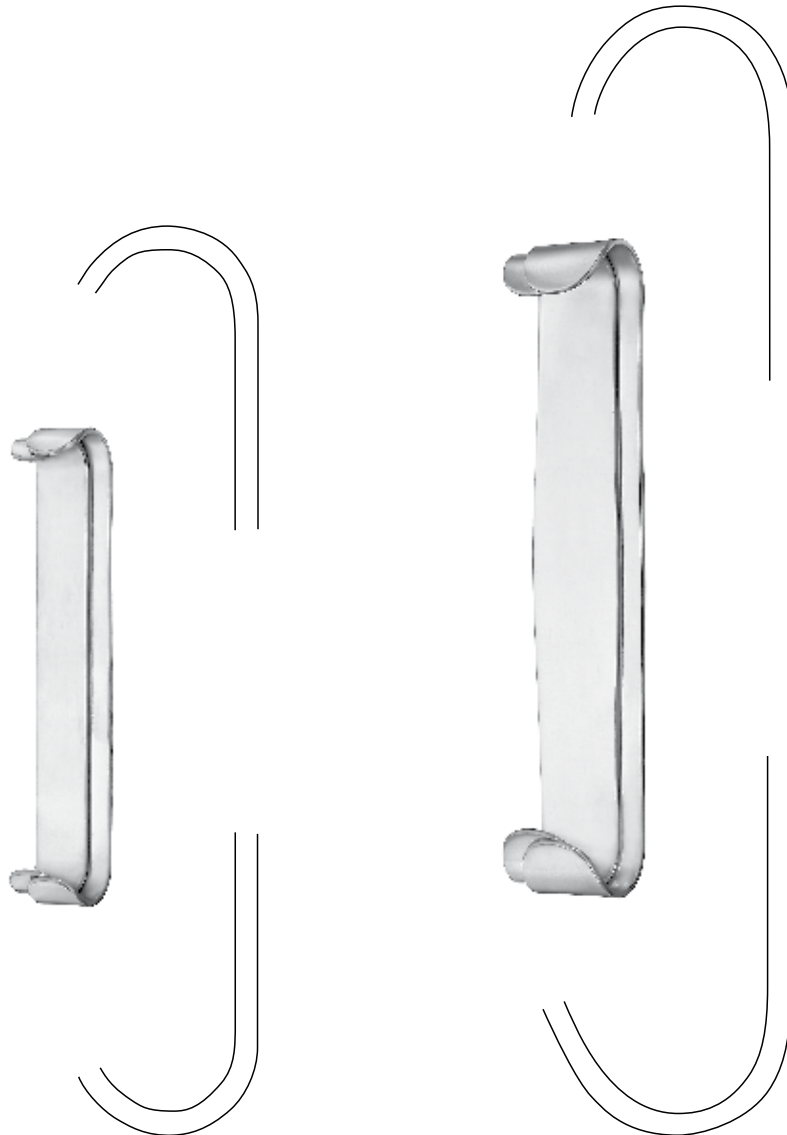

**2241.13**  
13 cm – 5 $\frac{1}{8}$ "  
**Parker**

**2241.18**  
18 cm – 7 $\frac{1}{8}$ "  
**Parker**



**Wundhaken, doppelendig**  
**Retractors double-ended • Separadores doble extremo**  
**Ecarteurs doubles • Divaricatori doppi**

- # 1 14,0 cm – 5½", 22 × 20 mm / 28 × 25 mm
- # 2 15,0 cm – 6", 26 × 23 mm / 38 × 29 mm
- # 3 16,5 cm – 6½", 29 × 29 mm / 44 × 34 mm

**2261.16** # 3  
**2261.15** # 2  
**2261.14** # 1



**2261.00**  
**Roux**  
 Satz komplett  
 Set complete  
 Juego completo  
 Jeu complet  
 Serie completa



**2281.21**  
 21 cm – 8¼"  
**Parker-Langenbeck**  
**(US-Army)**

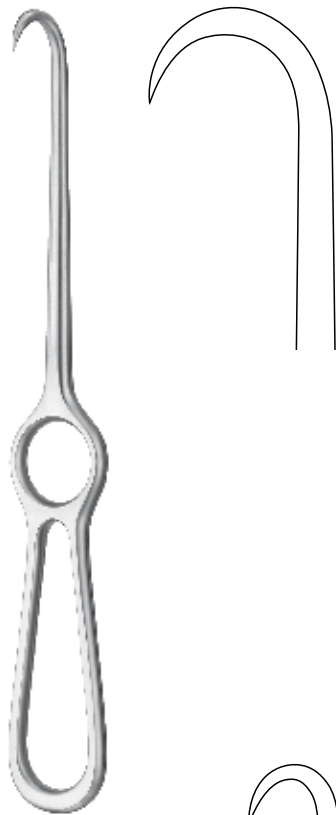

**2243.01**  
22 cm – 8¾"  
**Volkman**

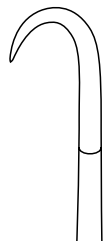

22 cm – 8¾"  
**Volkman**

9 mm



**2243.02**

13 mm

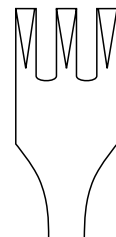

**2243.03**

18 mm

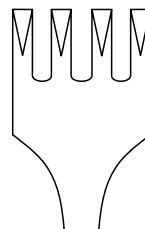

**2243.04**

28 mm

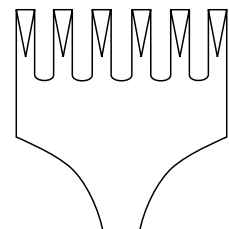

**2243.06**

**Wundhaken**  
**Retractors • Separadores**  
**Ecarteurs • Divaricatori**

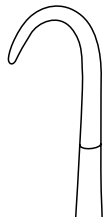
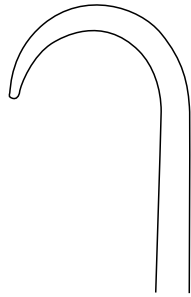

**2243.51**  
22 cm – 8<sup>3</sup>/<sub>4</sub>"  
**Volkman**



9 mm



**2243.52**

13 mm

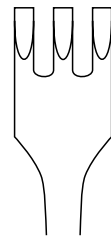

**2243.53**

18 mm

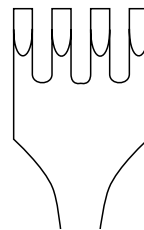

**2243.54**

28 mm

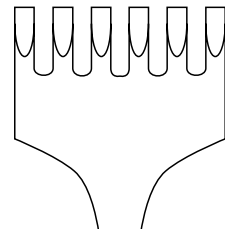

**2243.56**

22 cm – 8<sup>3</sup>/<sub>4</sub>"  
**Volkman**

**Wundhaken**  
**Retractors • Separadores**  
**Ecarteurs • Divaricatori**

---

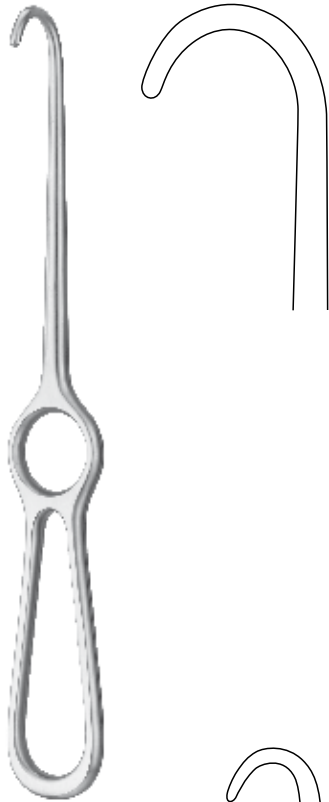

**2253.01**  
22 cm – 8¾"  
**Volkman**

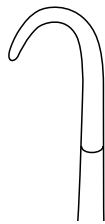

22 cm – 8¾"  
**Volkman**

9 mm



**2253.02**

13 mm

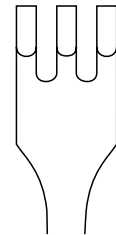

**2253.03**

18 mm

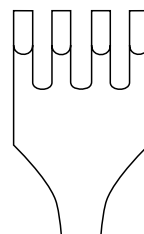

**2253.04**

28 mm

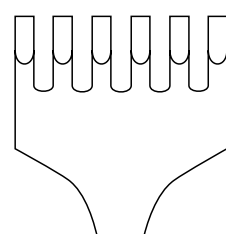

**2253.06**

**Wundhaken**  
**Retractors • Separadores**  
**Ecarteurs • Divaricatori**

---

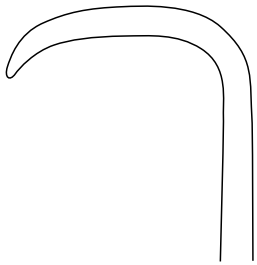

21 cm – 8¼"  
**Langenbeck**

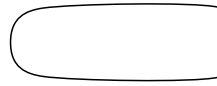

**3250.10**  
10 × 28 mm

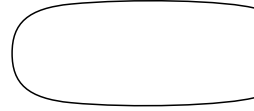

**3250.14**  
14 × 28 mm

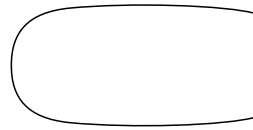

**3250.16**  
16 × 28 mm



23 cm – 9"  
**Kocher**



**3212.18**  
18 × 40 mm

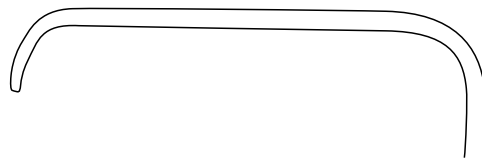

**3212.20**  
20 × 60 mm  
**3212.25**  
25 × 60 mm



**Wundhaken**  
**Retractors • Separadores**  
**Ecarteurs • Divaricatori**

---

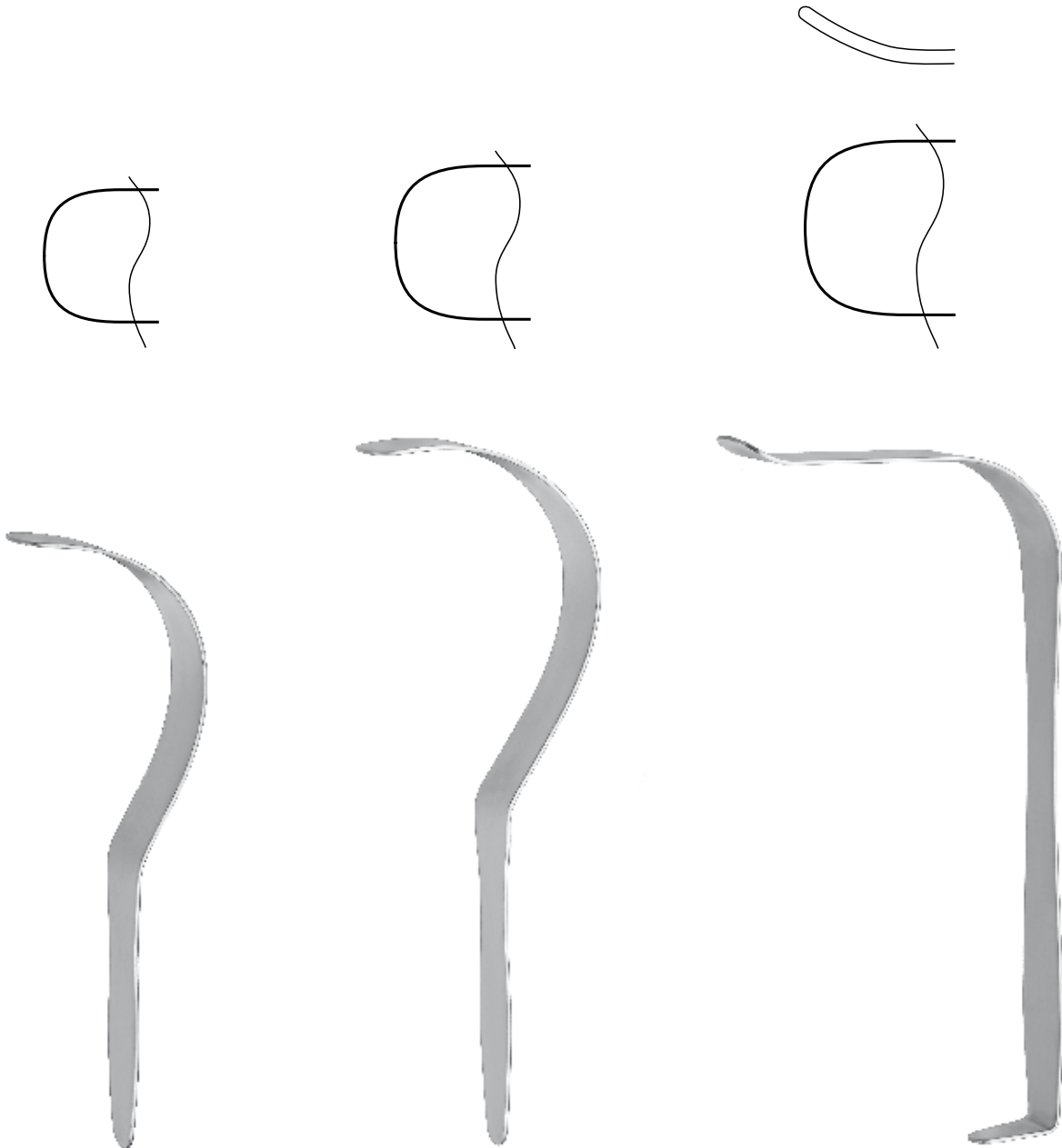

**3257.01**  
# 000  
18 cm – 7 $\frac{1}{8}$ "  
**Deaver**

**3257.02**  
# 00  
22 cm – 8 $\frac{3}{4}$ "  
**Deaver**

**3257.03**  
# 0  
23 cm – 9"  
**Deaver**



**Wundhaken**  
**Retractors • Separadores**  
**Ecarteurs • Divaricatori**

---

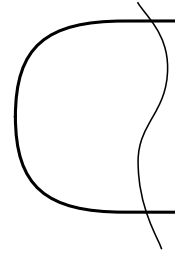
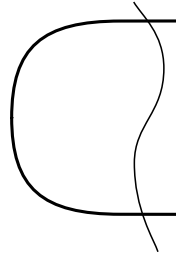
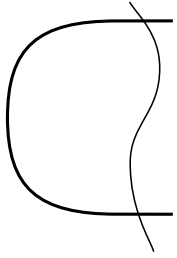

**3257.04**  
# 1  
30 cm – 11 $\frac{3}{4}$ "  
**Deaver**

**3257.05**  
# 2  
33 cm – 13"  
**Deaver**

**3257.06**  
# 2 $\frac{1}{2}$ "  
35 cm – 13 $\frac{3}{4}$ "  
**Deaver**

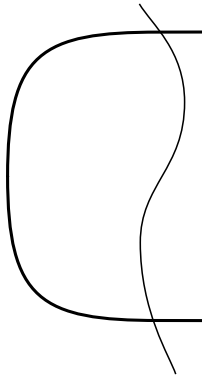

**3257.07**  
# 3  
30 cm – 11 $\frac{3}{4}$ "  
**Deaver**

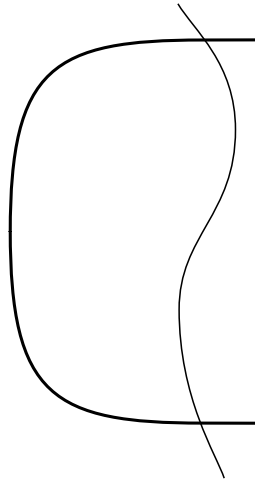

**3257.08**  
# 4  
30 cm – 11 $\frac{3}{4}$ "  
**Deaver**

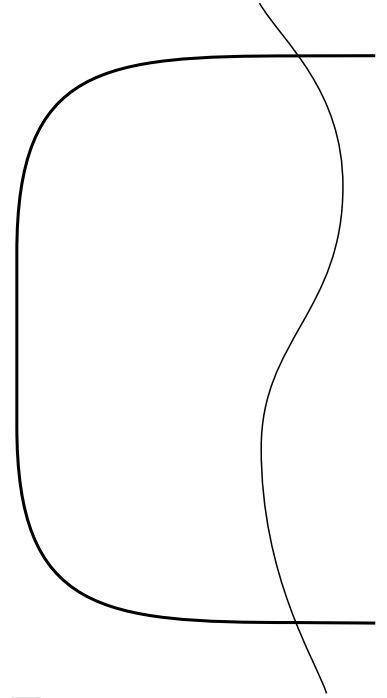

**3257.09**  
# 5  
30 cm – 11 $\frac{3}{4}$ "  
**Deaver**





**Lidhalter**

**Lid Retractors • Separadores para párpados  
Ecarteurs de paupières • Divaricatori per palpebre**

---



13 cm – 5 1/8"  
**Desmarres**

10 mm

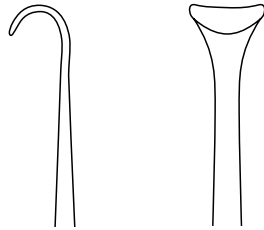

**0650.10**

12 mm

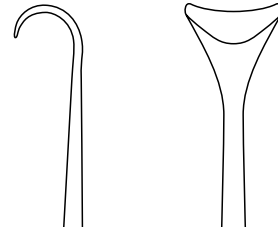

**0650.11**

14 mm

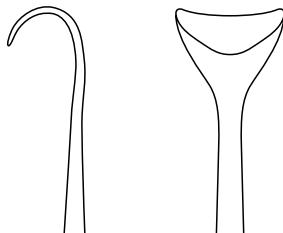

**0650.12**

16 mm

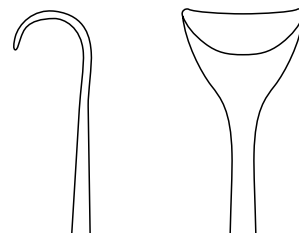

**0650.13**

18 mm

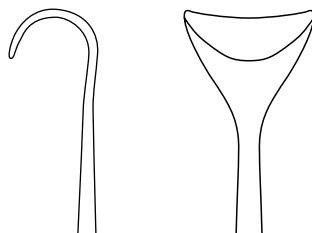

**0650.14**



**Wundspreizer**  
**Self-retaining Retractors**  
**Separadores autoestáticos**  
**Ecarteurs autostatiques**  
**Divaricatori autostatici**

**Wundspreizer**  
**Self-retaining Retractors • Separadores autoestáticos**  
**Ecarteurs autostatiques • Divaricatori autostatici**

13 mm



scharf  
sharp  
agudo  
pointu  
acuto  
**4222.10**

10,5 cm – 4 1/8"  
**Weitlaner**

stumpf  
blunt  
romo  
mousse  
smusso  
**4222.11**

scharf  
sharp  
agudo  
pointu  
acuto  
**4222.13**



stumpf  
blunt  
romo  
mousse  
smusso  
**4222.14**

13 cm – 5 1/8"  
**Weitlaner**

16 mm



scharf  
sharp  
agudo  
pointu  
acuto  
**4222.16**

16,5 cm – 6 1/2"  
**Weitlaner**

stumpf  
blunt  
romo  
mousse  
smusso  
**4222.17**



**Wundspreizer**  
**Self-retaining Retractors • Separadores autoestáticos**  
**Ecarteurs autostatiques • Divaricatori autostatici**

---

17 mm



scharf  
sharp  
agudo  
pointu  
acuto

**4223.04**  
31 cm – 12 $\frac{1}{8}$ "  
**Beckmann**



**4204.14**  
14 cm – 5 $\frac{1}{2}$ "  
**Gelpi-Baby**

**Bauchdeckenhalter**  
**Abdominal Retractors • Separadores abdominales**  
**Ecarteurs abdominaux • Divaricatori addominali**

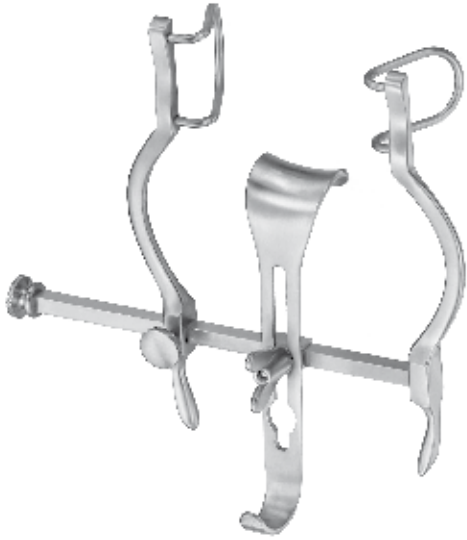

**4207.01**  
**Balfour-Baby**



**4207.10**  
**4207.15**  
**4207.17**  
**Balfour**

Spreizer komplett  
 Spreader complete  
 Separador completo  
 Ecarteur complet  
 Divaricatore completo

Spreizweite max.  
 Spread max.  
 Apertura máxima  
 Ecartement maximal  
 Apertura massima

Seitenvalven  
 Side blades  
 Valvas laterales  
 Valves latérales  
 Valve laterali

Mittelvalven  
 Center blades  
 Valvas centrales  
 Valves centrales  
 Valve centrali

**4207.01**  
**4207.10**  
**4207.10**  
**4207.17**

90 mm  
 180 mm  
 180 mm  
 250 mm

27 × 27 mm  
 65 × 35 mm  
 100 × 35 mm  
 100 × 35 mm

24 × 24 mm  
 75 × 50 mm  
 85 × 65 mm  
 85 × 65 mm

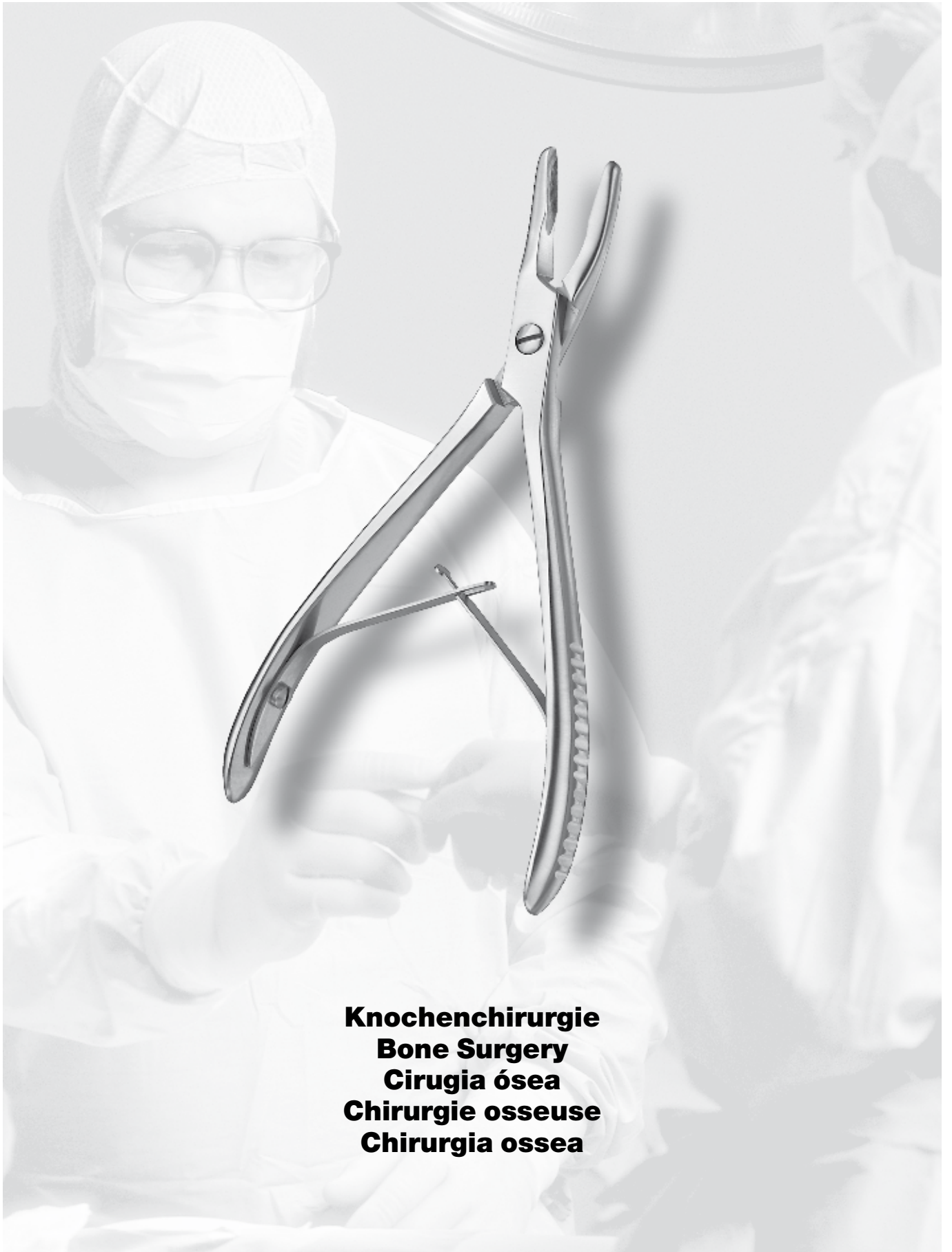

**Knochenchirurgie**  
**Bone Surgery**  
**Cirurgia ósea**  
**Chirurgie osseuse**  
**Chirurgia ossea**



**Scharfe Löffel**  
**Bone Currettes • Cucharillas cortantes**  
**Currettes tranchantes • Cucchiali taglienti**

---



17 cm – 6<sup>3</sup>/<sub>4</sub>"  
**Volkman**



**9215.24**  
# 0000



**9215.33**  
# 000



**9215.42**  
# 00



**9215.50**  
# 0



**9215.51**  
# 1



**9215.52**  
# 2



**9215.53**  
# 3



**9215.54**  
# 4

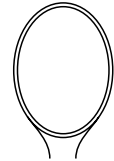

**9215.55**  
# 5



**9215.56**  
# 6

**Hohlmeißelzangen**  
**Bone Rongeurs • Pinzas-gubias**  
**Pinces-gouges • Pinze-sgorbie**

---



**0350.14**  
14 cm – 5½"  
**Friedmann**

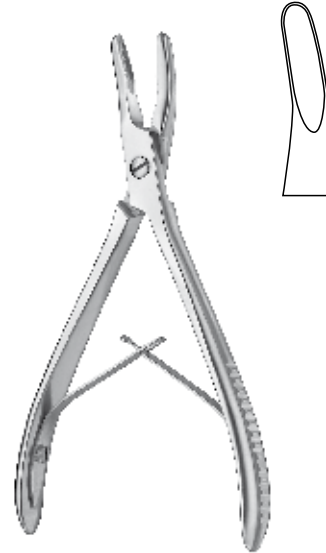

**0303.15**  
15 cm – 6"  
**Luer**



16 cm – 6¼"  
**Blumenthal**

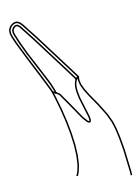

30°

**0352.30**

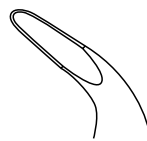

45°

**0352.45**

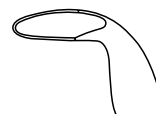

90°

**0352.90**



**Hohlmeißelzangen**  
**Bone Rongeurs • Pinzas-gubias**  
**Pinces-gouges • Pinze-sgorbie**

---

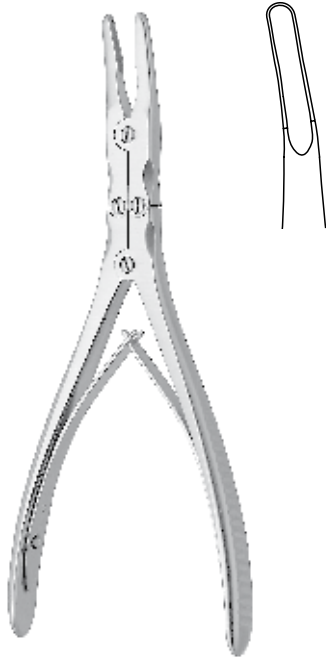

**1311.04**  
18 cm – 7 1/8"  
**Beyer**

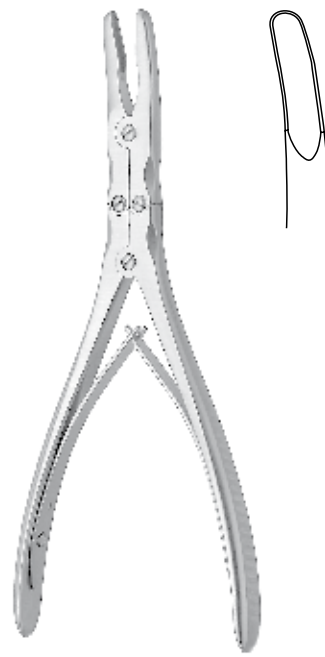

**1311.05**  
18 cm – 7 1/8"  
**Zaufal-Jansen**

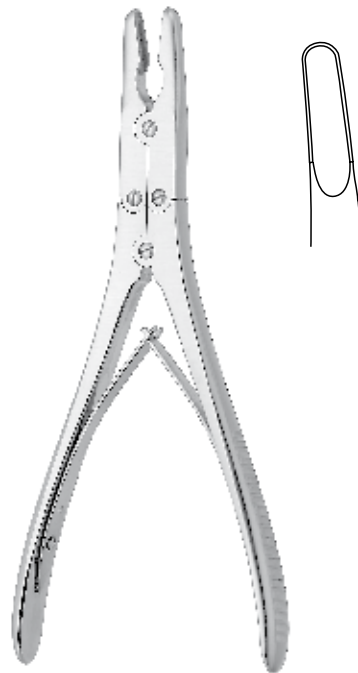

**1370.05**  
18 cm – 7 1/8"  
**Ruskin**



**Hohlmeißelzangen**  
**Bone Rongeurs • Pinzas-gubias**  
**Pinces-gouges • Pinze-sgorbie**

---

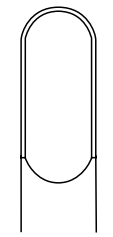

**1303.23**



**1313.23**

23 cm – 9"  
**Stille-Luer**



**Knochensplitterzangen**  
**Bone Cutting Forceps • Pinzas cortantes para huesos**  
**Pinces coupantes • Pinze ossivore**

---



**3302.14**  
**3302.17**  
**Liston**

14 cm – 5½"  
17 cm – 6¾"

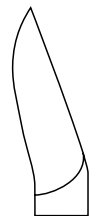

**3312.14**  
**3312.17**  
**Liston**

14 cm – 5½"  
17 cm – 6¾"

**bob**  
instruments

best of basic instruments

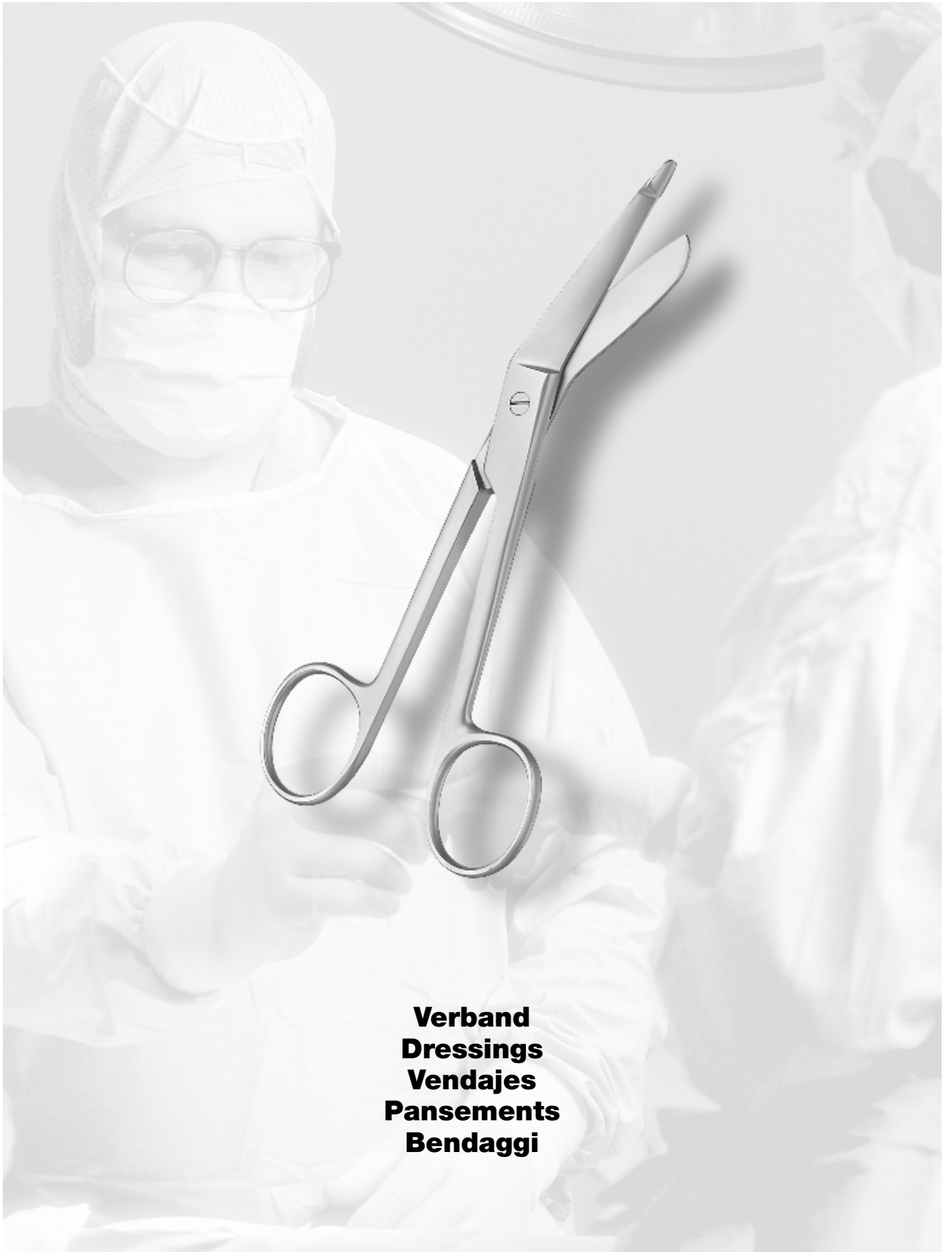

**Verband**  
**Dressings**  
**Vendajes**  
**Pansements**  
**Bendaggi**

**Verbandscheren**  
**Bandage Scissors • Tijeras para vendajes**  
**Ciseaux à pansements • Forbici per bendaggi**

---



**0413.20**  
20 cm – 8"  
**Esmarch**



**0433.23**  
23 cm – 9"  
**Bergmann**



**0414.23**  
24 cm – 9½"  
**Bruns**



**0452.11** 11,5 cm – 4½"  
**0452.14** 14 cm – 5½"  
**0452.18** 18 cm – 7¼"  
**0452.20** 20 cm – 8"

**Lister**

## Gipsspreizer / Gipsabreißzangen

Plaster Spreaders / Plaster Cast Breakers • Pinzas para abrir vendajes / Pinzas para arrancar vendajes enyesados  
Ecarteurs à plâtre / Pincas pour arracher les plâtres • Allargagessi / Pinze strappagessi

---

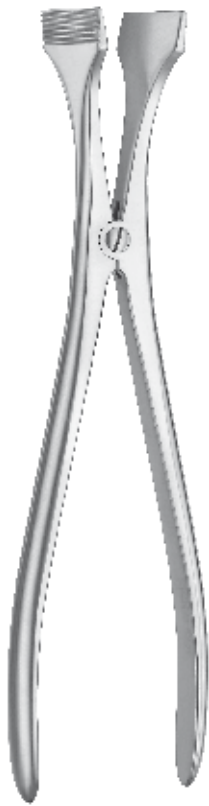

**0407.27**  
27 cm – 10¾"  
**Hennig**



**0457.23**  
23 cm – 9"  
**Mod. USA**



**0418.18**  
18 cm – 7⅛"  
**0418.24**  
24 cm – 9½"  
**Wolff-Boehler**



**Gipsscheren**  
**Plaster Shears • Cizalla para vendajes**  
**Cisailles à plâtre • Cesioie per bendaggi**

---

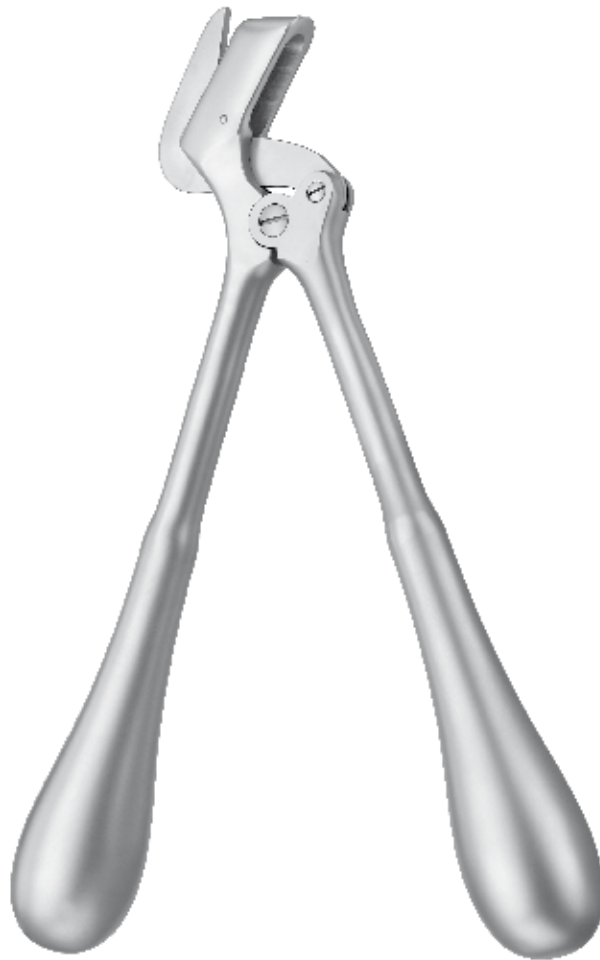

**0455.23** 23 cm – 9"  
**0455.26** 26 cm – 10¼"  
**0455.37** 37 cm – 14½"  
**Stille**

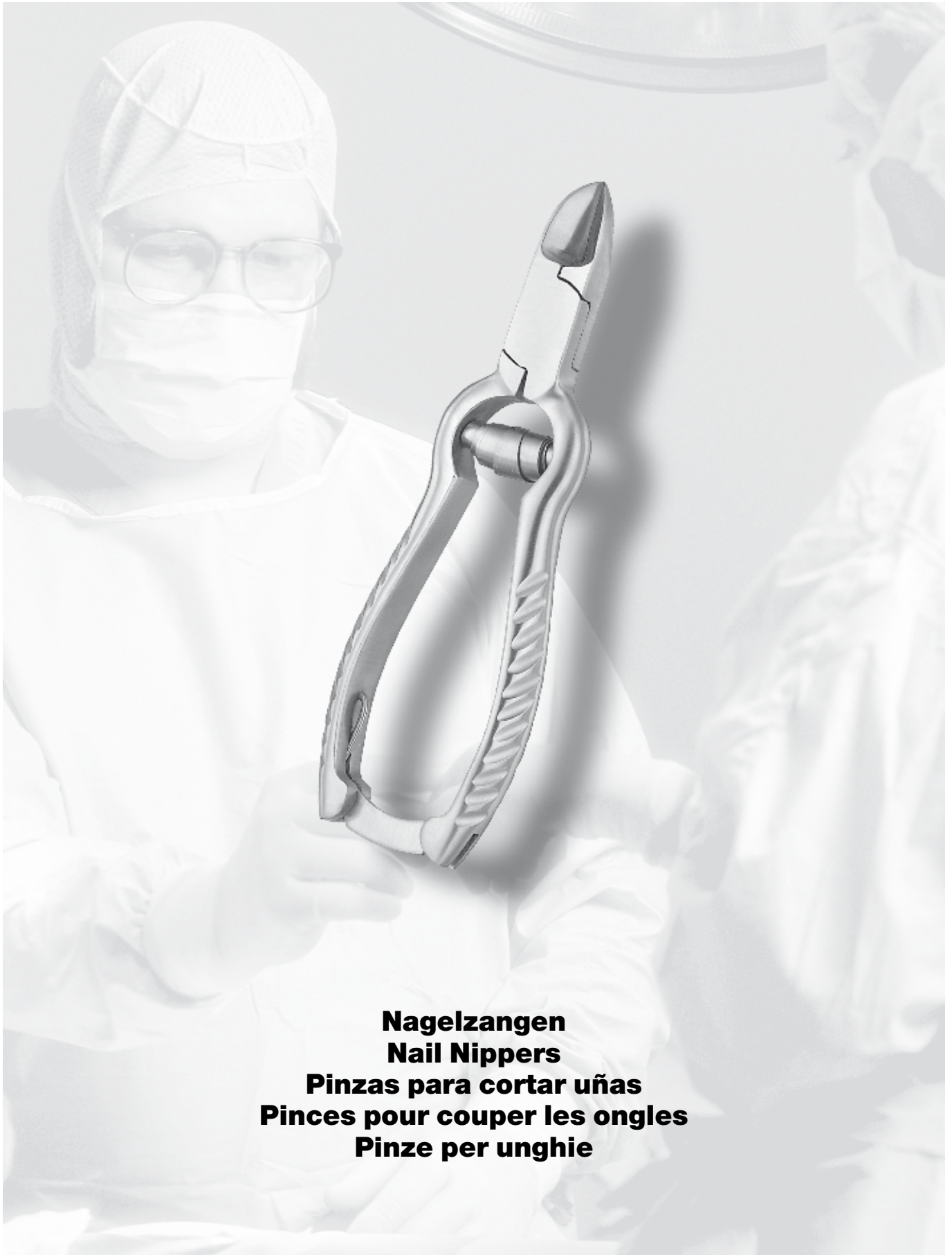

**Nagelzangen**  
**Nail Nippers**  
**Pinzas para cortar uñas**  
**Pinces pour couper les ongles**  
**Pinze per unghie**



**Nagelzangen**  
**Nail Nippers • Pinzas para cortar uñas**  
**Pinces pour couper les ongles • Pinze per unghie**

---



**3407.83**  
13 cm – 5 $\frac{1}{8}$



**3437.13**  
13 cm – 5 $\frac{1}{8}$



**3457.14**  
14 cm – 5 $\frac{1}{2}$

Standardmodell  
Standard Pattern  
Modelo estándar  
Modèle standard  
Modello standard

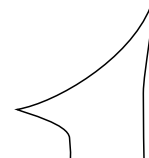

**3477.84**  
14 cm – 5 $\frac{1}{2}$

Französisches Modell  
French Pattern  
Modelo francés  
Modèle français  
Modello francese



**Nagelspaltzange / Fingerringsäge**

**Nail Splitter / Finger Ring Cutter • Pinza corta-uñas / Sierra para abrir anillos**

**Pince pour couper les ongles / Scie pour couper les bagues • Tronchesina per unghie / Sega per anelli**

---



**3487.13**  
13 cm – 5 $\frac{1}{8}$



**3454.00**  
16 cm – 6 $\frac{1}{4}$



**bob**  
instruments

best of basic instruments



**Diagnostik**  
**Diagnostics**  
**Diagnóstico**  
**Diagnostic**  
**Diagnostica**

## Hämmer / Kathetereinführzangen

Mallets / Catheter Introducing Forceps • Martillos / Pinzas para introducir catéteres  
Maillets / Pinces pour introduire les sondes • Martelli / Pinze per introdurre cateteri

---



**4421.05**  
18 cm – 7 $\frac{1}{8}$ "  
**Buck**



**4470.50**  
20 cm – 8"  
**Taylor**



**Magill**



**5457.01**  
16 cm – 6 $\frac{1}{4}$ "



**5457.02**  
19 cm – 7 $\frac{1}{2}$ "



**5457.03**  
24 cm – 9 $\frac{1}{2}$ "

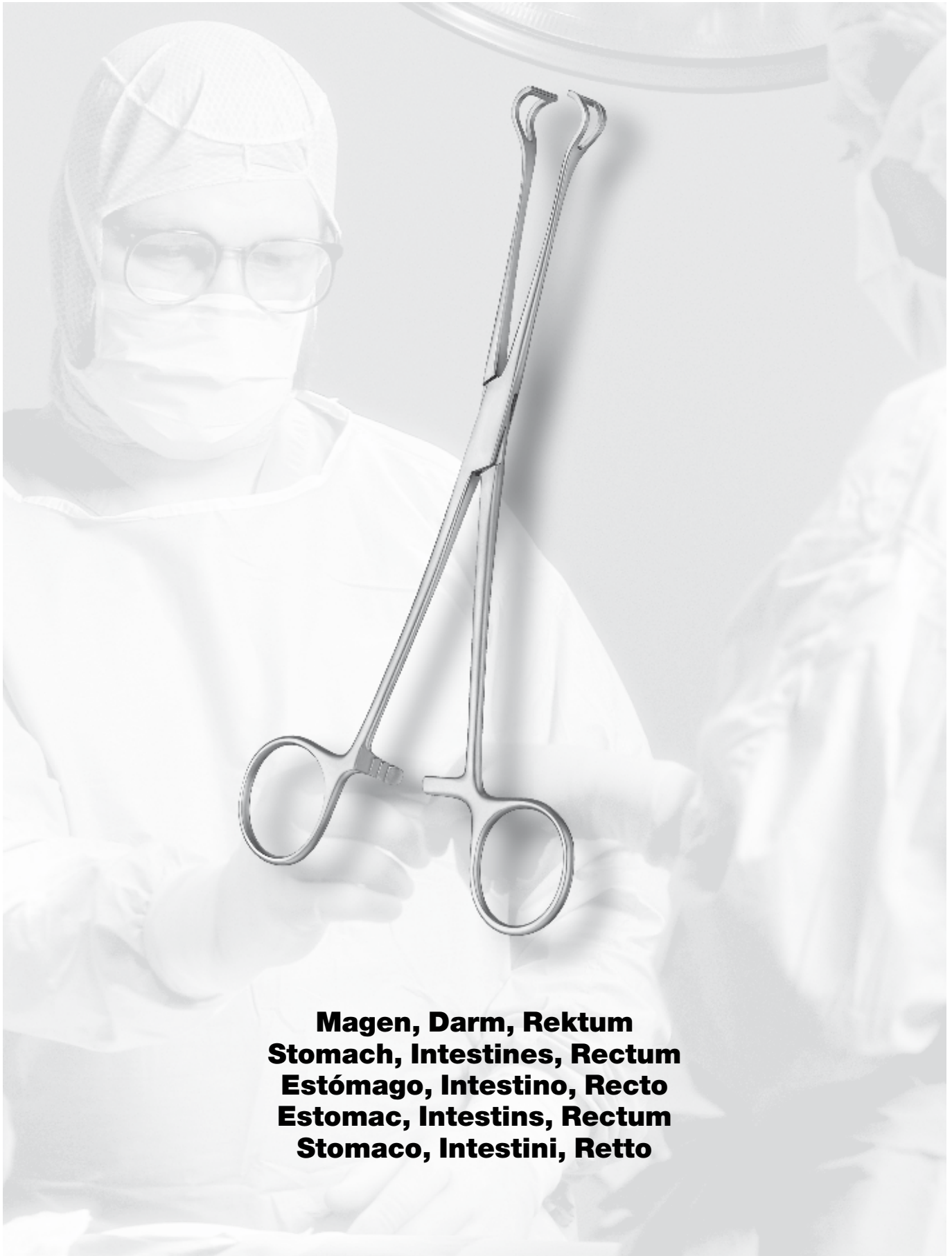

**Magen, Darm, Rektum**  
**Stomach, Intestines, Rectum**  
**Estómago, Intestino, Recto**  
**Estomac, Intestins, Rectum**  
**Stomaco, Intestini, Retto**

**Darm- und Gewebefaßzangen**  
**Intestinal and Tissue Forceps • Pinzas para coger intestino y tejidos**  
**Pinces pour saisir l'intestin et les tissus • Pinze per afferrare intestino e tessuti**



4 × 5 Zähne  
 4 × 5 teeth  
 4 × 5 dientes  
 4 × 5 dents  
 4 × 5 denti

**0520.13**  
 13 cm – 5 1/8"  
**Allis-Baby**

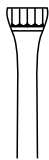

4 × 5 Zähne  
 4 × 5 teeth  
 4 × 5 dientes  
 4 × 5 dents  
 4 × 5 denti

**0520.15**  
 15 cm – 6"  
**Allis**



5 × 6 Zähne  
 5 × 6 teeth  
 5 × 6 dientes  
 5 × 6 dents  
 5 × 6 denti

**0520.16** 15 cm – 6"  
**0520.19** 19 cm – 7 1/2"  
**Allis**

**Darm- und Gewebefäßzangen**  
**Intestinal and Tissue Forceps • Pinzas para coger intestino y tejidos**  
**Pinces pour saisir l'intestin et les tissus • Pinze per afferrare intestino e tessuti**

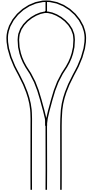

**0501.16**  
16 cm – 6¼"



**0511.16**  
16 cm – 6¼"

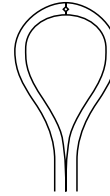

**0501.20**  
20 cm – 8"



**0511.20**  
20 cm – 8"  
 atraumatisch  
 atraumatic  
 atraumática  
 atraumatique  
 atraumatica

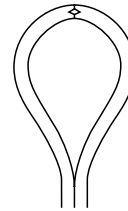

**0501.23**  
23 cm – 9"

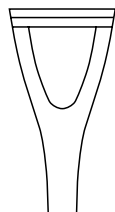

**Babcock**





**Darmklemmen**  
**Intestinal Forceps • Pinzas intestinales**  
**Pinces intestinales • Pinze intestinali**

---



**Kocher**

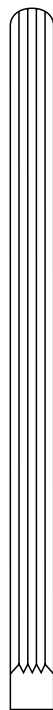

**0522.23**  
23 cm – 9"

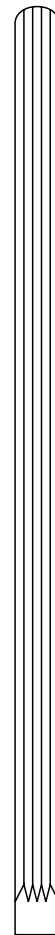

**0522.26**  
26 cm – 10¼"

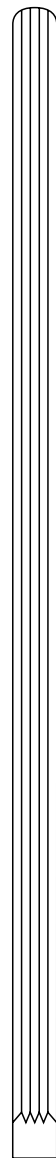

**0522.28**  
28 cm – 11"



**Darmklemmen**  
**Intestinal Forceps • Pinzas intestinales**  
**Pinces intestinales • Pinze intestinali**

---



**Kocher**



**0532.23**  
23 cm – 9"

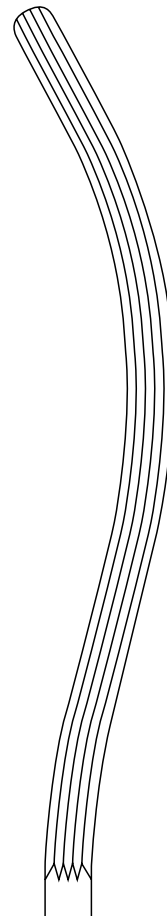

**0532.26**  
26 cm – 10¼"

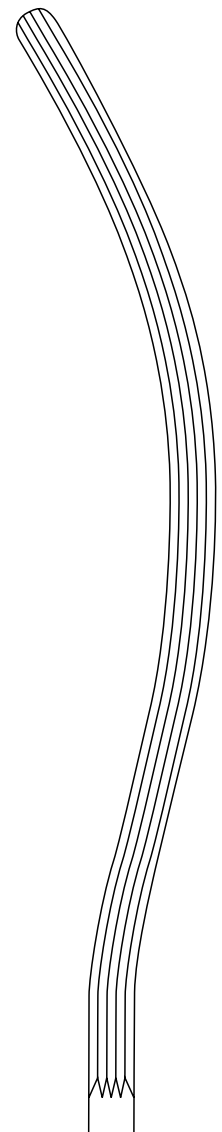

**0532.28**  
28 cm – 11"

**Rektalspekula**  
**Rectal Specula • Espéculos rectales**  
**Spéculums rectaux • Specoli rettali**

---



**0537.05**  
16 cm – 6¼"  
**Sims**



**0537.20**  
21 cm – 8¼"  
**Pratt**

**Sphinkterskope / Hämorrhoidenfaßzange**  
**Sphincteroscopes / Haemorrhoidal Grasping Forceps • Esfinteroscopios / Pinza hemorroidal**  
**Sphincteroscopes / Pince pour saisir les hémorroïdes • Sfinteroscopi / Pinza per prendere emoroidi**

---



**0577.72**    Ø 25 × 50 mm  
**0577.73**    Ø 21 × 50 mm  
**Kelly**

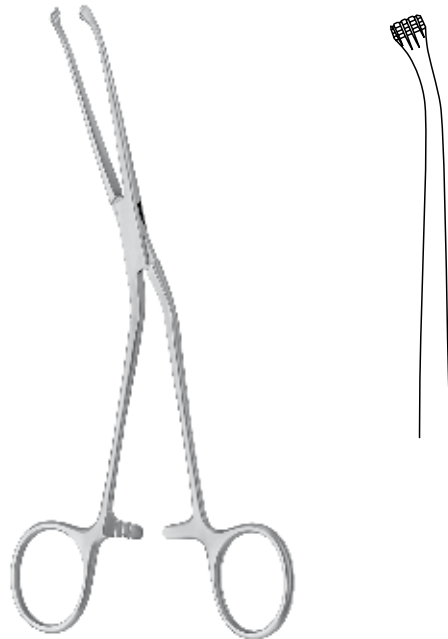

**0539.90**  
19 cm – 7½"  
**Mc Givney**





**Galle, Niere, Urologie**  
**Gall bladder, Kidney, Urology**  
**Biliares, Renales, Urología**  
**Vésicule biliaire, Reins, Urologie**  
**Biliari, Renali, Urologia**



**Gallensteinlöffel**

**Gall Stone Scoops • Cucharillas para cálculos biliares  
Curettes pour calculs biliaires • Cucchiaio per calcoli biliari**

---



**1541.06**  
# 1



**1541.07**  
# 2

30 cm – 11¾"  
**Desjardins**

**Nierensteinzangen**  
**Kidney Stone Forceps • Pinzas para cálculos renales**  
**Pinces pour calculs rénaux • Pinze per calcoli renali**

---



23 cm - 9"  
**Randall**

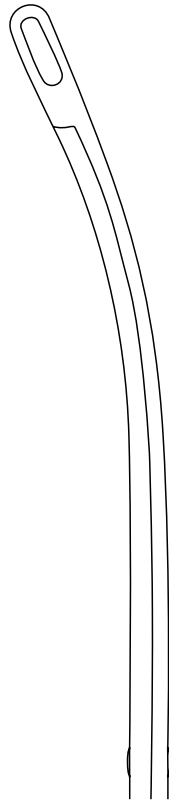

**1585.01**  
# 1

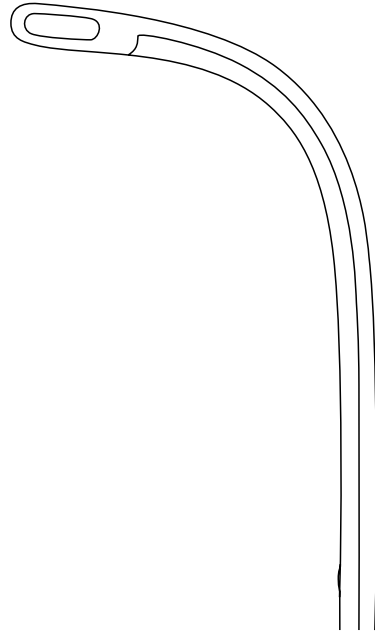

**1585.02**  
# 2

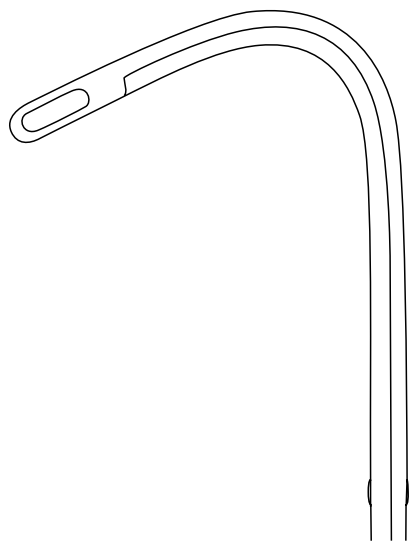

**1585.03**  
# 3

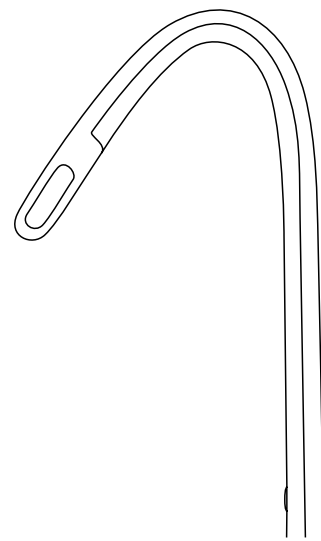

**1585.04**  
# 4





**Penisklemmen**  
**Meatus Clamps • Pinzas para el pene**  
**Compresseurs à ressort pour le pénis • Pinze serrapene**

---



**1557.05**  
8 cm – 3 $\frac{1}{8}$ "  
**Stockmann**



**1557.10**  
12 cm – 4 $\frac{3}{4}$ "  
**Strauss**

**bob**  
instruments

best of basic instruments



**Gynäkologie**  
**Gynecology**  
**Ginecología**  
**Gynécologie**  
**Ginecologia**



**Scheidenspekula**  
**Vaginal Specula • Espéculos vaginales**  
**Spéculums vaginaux • Specoli vaginali**

---



**2510.00**  
75 × 17 mm  
**Cusco**



**2510.02** 75 × 32 mm  
**2510.03** 85 × 36 mm  
**2510.04** 95 × 37 mm  
**Cusco**



**2550.07** 76 × 13 mm  
**2550.10** 100 × 22 mm  
**2550.12** 120 × 25 mm  
**Pederson**



**2560.07** 75 × 20 mm  
**2560.10** 100 × 30 mm  
**2560.12** 115 × 35 mm  
**Graves**

**Scheidenspekula / Uterussonden**  
**Vaginal Specula / Uterine Probes • Espéculos vaginales / Histerómetros**  
**Spéculum vaginaux / Hystéromètres • Specoli vaginali / Isterometri**



**2502.00**  
**Sims**

# 1	70 × 25 mm 75 × 30 mm
# 2	75 × 30 mm 80 × 35 mm
# 3	80 × 35 mm 90 × 40 mm



32 cm – 12½"  
**Sims**

**2504.01**

biegsam  
 malleable  
 maleable  
 malléable  
 malleabile

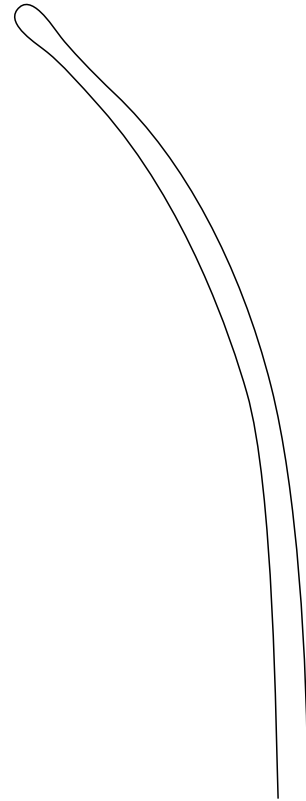

graduiert in cm  
 graduated in cm  
 graduación en cm  
 gradué en cm  
 graduato in cm

**2504.11**

starr  
 rigid  
 rígido  
 rigide  
 rigido

**Hakenzangen**  
**Tenaculum Forceps • Pinzas para cuello**  
**Pinces pour le col • Pinze per il collo**

---



**2544.25**  
25 cm – 10"  
**Schroeder**

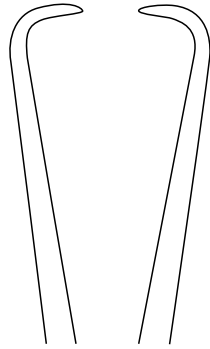

**2544.60**  
25,5 cm – 10"  
**Pozzi**

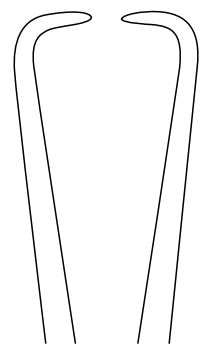



**Myomheber**  
**Myoma Screws • Tirabuzones para fibroma**  
**Tracteurs pour fibromes • Tiramioni**

---



**2505.01**  
14 cm – 5½"  
**Doyen**

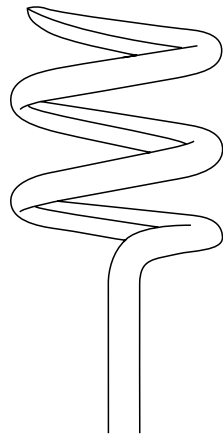

Ø 29 mm



**2505.02**  
17 cm – 6¾"  
**Doyen**

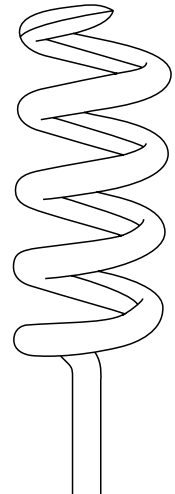

Ø 20 mm



**Uterusküretten**  
**Uterine Curettes • Curetas uterinas**  
**Curettes utérines • Curette uterine**



scharf  
sharp  
agudo  
pointue  
acuto

# 00



**2518.00**

# 0



**2518.10**  
**2518.50**

# 1



**2518.11**  
**2518.51**

# 2



**2518.12**  
**2518.52**



biegsam  
malleable  
maleable  
malléable  
malleabile

# 3



**2518.13**  
**2518.53**

# 4



**2518.14**  
**2518.54**

# 5



**2518.15**  
**2518.55**

# 6



**2518.16**  
**2518.56**

31 cm – 12 1/8"  
**Recamier**

# 7

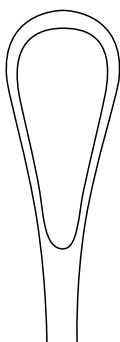

**2518.17**  
**2518.57**

# 8

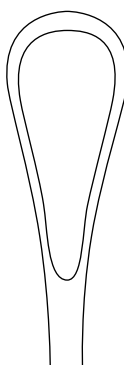

**2518.18**  
**2518.58**

# 9

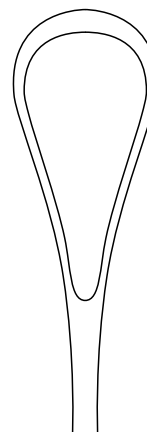

**2518.19**  
**2518.59**

# 10

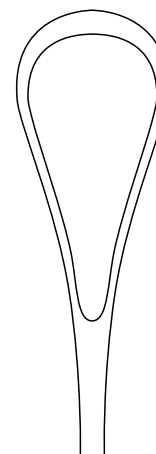

**2518.20**  
**2518.60**



**Uterusküretten**  
**Uterine Curettes • Curetas uterinas**  
**Curettes utérines • Curette uterine**



stumpf  
 blunt  
 romo  
 mousse  
 smusso

# 00



**2528.00**

# 0



**2528.10**  
**2528.50**

# 1



**2528.11**  
**2528.51**

# 2



**2528.12**  
**2528.52**

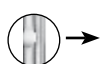

# 3



**2528.13**  
**2528.53**

# 4



**2528.14**  
**2528.54**

# 5



**2528.15**  
**2528.55**

# 6

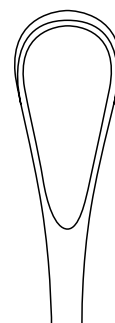

**2528.16**  
**2528.56**

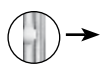

biegsam  
 malleable  
 maleable  
 malléable  
 malleabile

31 cm – 12 1/8"  
**Recamier**

# 7

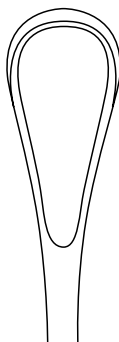

**2528.17**  
**2528.57**

# 8

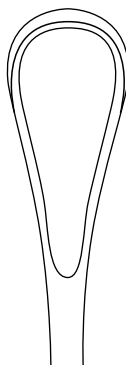

**2528.18**  
**2528.58**

# 9

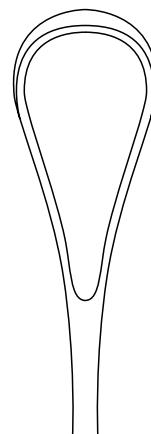

**2528.19**  
**2528.59**

# 10

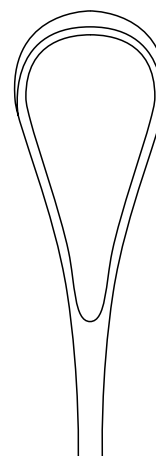

**2528.20**  
**2528.60**

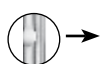





**Biopsiezangen**  
**Biopsy Forceps • Pinzas para biopsia**  
**Pinces à biopsie • Pinze per biopsia**

---

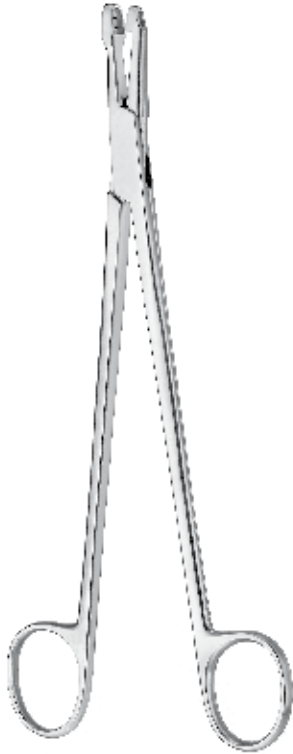

**2556.02**  
21 cm – 8¼"  
**Schubert**



**2556.04**  
24 cm – 9½"  
**Schubert**

**Biopsiezangen**  
**Biopsy Forceps • Pinzas para biopsia**  
**Pinces à biopsie • Pinze per biopsia**

---



**2556.05**  
24 cm – 9½"  
**Van Doren**

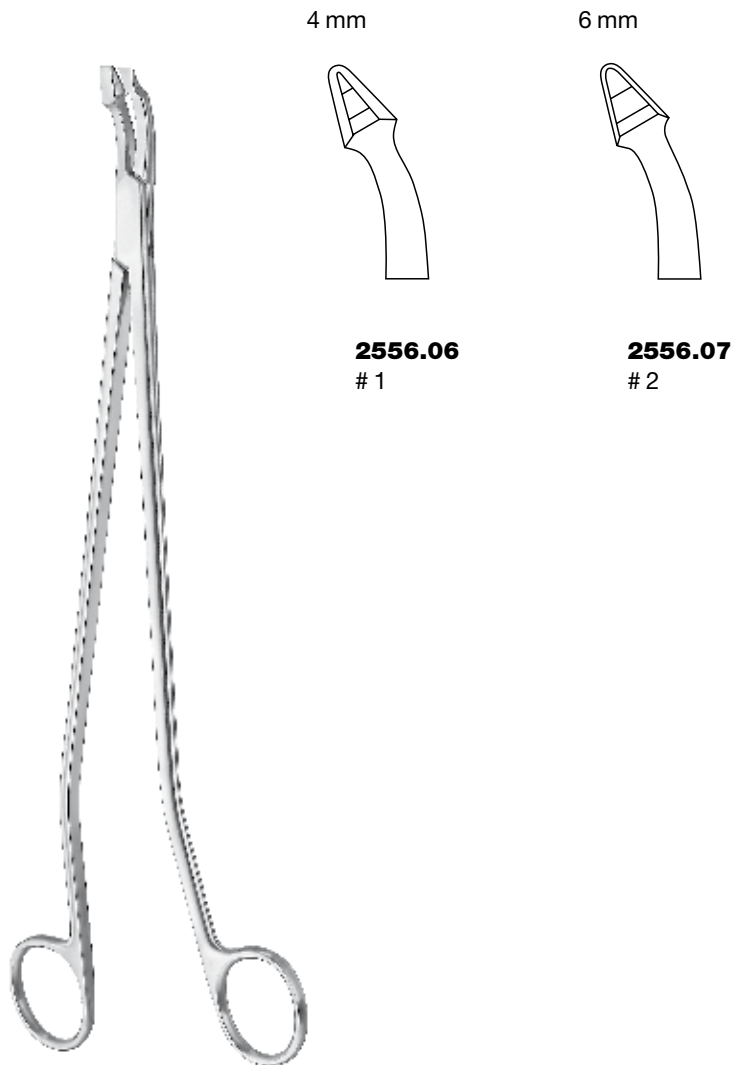

4 mm

6 mm

**2556.06**  
# 1

**2556.07**  
# 2

28 cm – 11"  
**Schumacher-Van Doren**

**Biopsiezangen**  
**Biopsy Forceps • Pinzas para biopsia**  
**Pinces à biopsie • Pinze per biopsia**

---



**2546.00**  
22 cm – 8¾"  
**Burke**



**2546.05**  
22 cm – 8¾"  
**Tischler-Kevorkian**

**Biopsiezangen**  
**Biopsy Forceps • Pinzas para biopsia**  
**Pinces à biopsie • Pinze per biopsia**

---

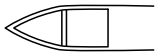

**2546.10**  
22 cm – 8<sup>3</sup>/<sub>4</sub>"  
**Tischler**

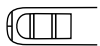
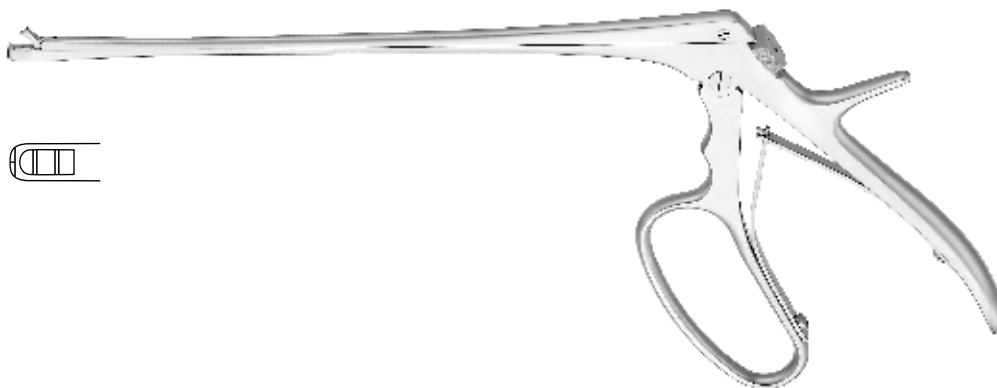

**2546.15**  
20 cm – 8"  
**Baby-Tischler**

**Biopsiezangen**  
**Biopsy Forceps • Pinzas para biopsia**  
**Pinces à biopsie • Pinze per biopsia**

---



**2546.20**  
22 cm – 8¾"  
**Tischler-Morgan**

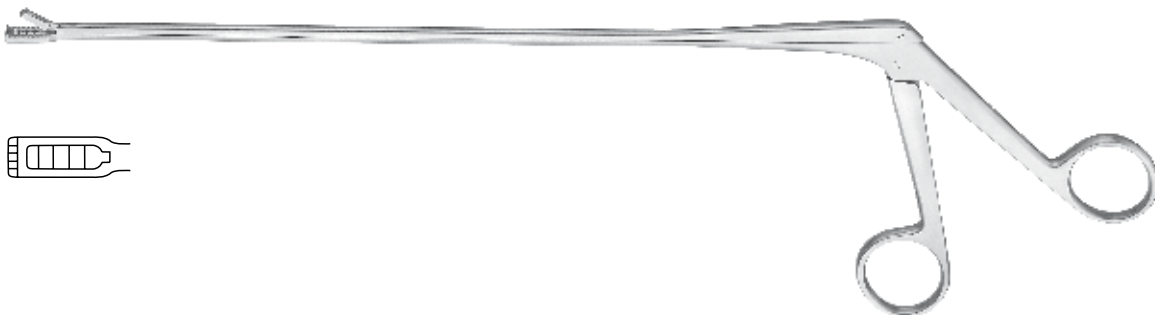

**2586.80**  
25 cm – 10"  
**Kevorkian-Young**

**bob**  
instruments

best of basic instruments



**Geburtshilfe**  
**Obstetrics**  
**Obstetricia**  
**Obstétrique**  
**Ostetricia**

**Dammscheren / Uterusklemmzange**  
**Episiotomy Scissors / Uterine Clamp Forceps • Tijeras perineales / Pinza-clamp uterina**  
**Ciseaux périnéaux / Pince-clamp utérine • Forbici perineali / Pinza serra-utero**



**3503.15**  
 15 cm – 6"  
**Braun-Stadler**

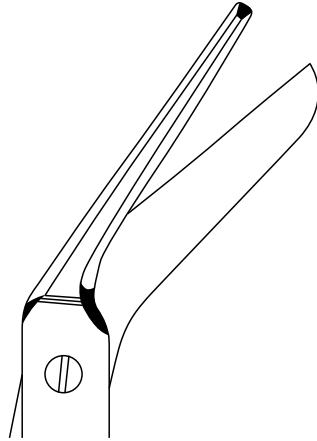

**3513.18**  
 18 cm – 7 1/8"  
**Waldmann**

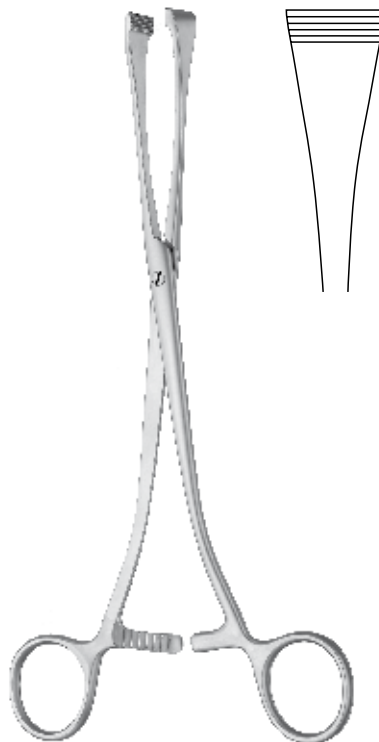
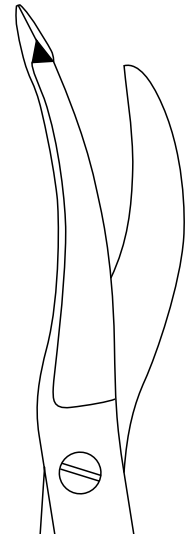

**3551.22**  
 20,5 cm – 8"  
**Green-Armytage**



**Nabelschnurscheren**  
**Umbilical Scissors • Tijeras para cordón umbilical**  
**Ciseaux pour le cordon ombilical • Fobici per cordone ombelicale**

---



**3526.11**  
11 cm – 4<sup>3</sup>/<sub>8</sub>"  
**Mod. USA**



**3526.16**  
16 cm – 6<sup>1</sup>/<sub>4</sub>"  
**Busch**

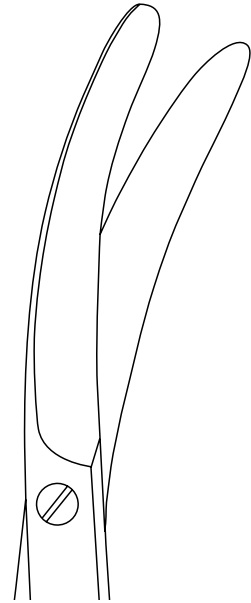





**Geburtszangen**  
**Obstetrical Forceps • Fórceps obstétricos**  
**Forceps obstétricaux • Forcipi ostetricia**

---



**3505.05**  
23 cm – 9"  
**Simpson**



**3505.10**  
28 cm – 11"  
**Wrigley**

**Geburtszangen**  
**Obstetrical Forceps • Fórceps obstétricos**  
**Forceps obstétricaux • Forcipi ostetricia**

---



**3505.25**  
36 cm – 14 $\frac{1}{8}$ "  
**Naegele**



**3505.50**  
30 cm – 11 $\frac{3}{4}$ "  
**Simpson**

**3505.51**  
36 cm – 14 $\frac{1}{8}$ "  
**Simpson-Braun**

**Geburtszangen**  
**Obstetrical Forceps • Fórceps obstétricos**  
**Forceps obstétricaux • Forcipi ostetricia**

---



**3505.60**  
40 cm – 15¾"  
**Kielland**



**3505.65**  
44 cm – 17⅓"  
**Piper**

**bob**  
instruments

best of basic instruments

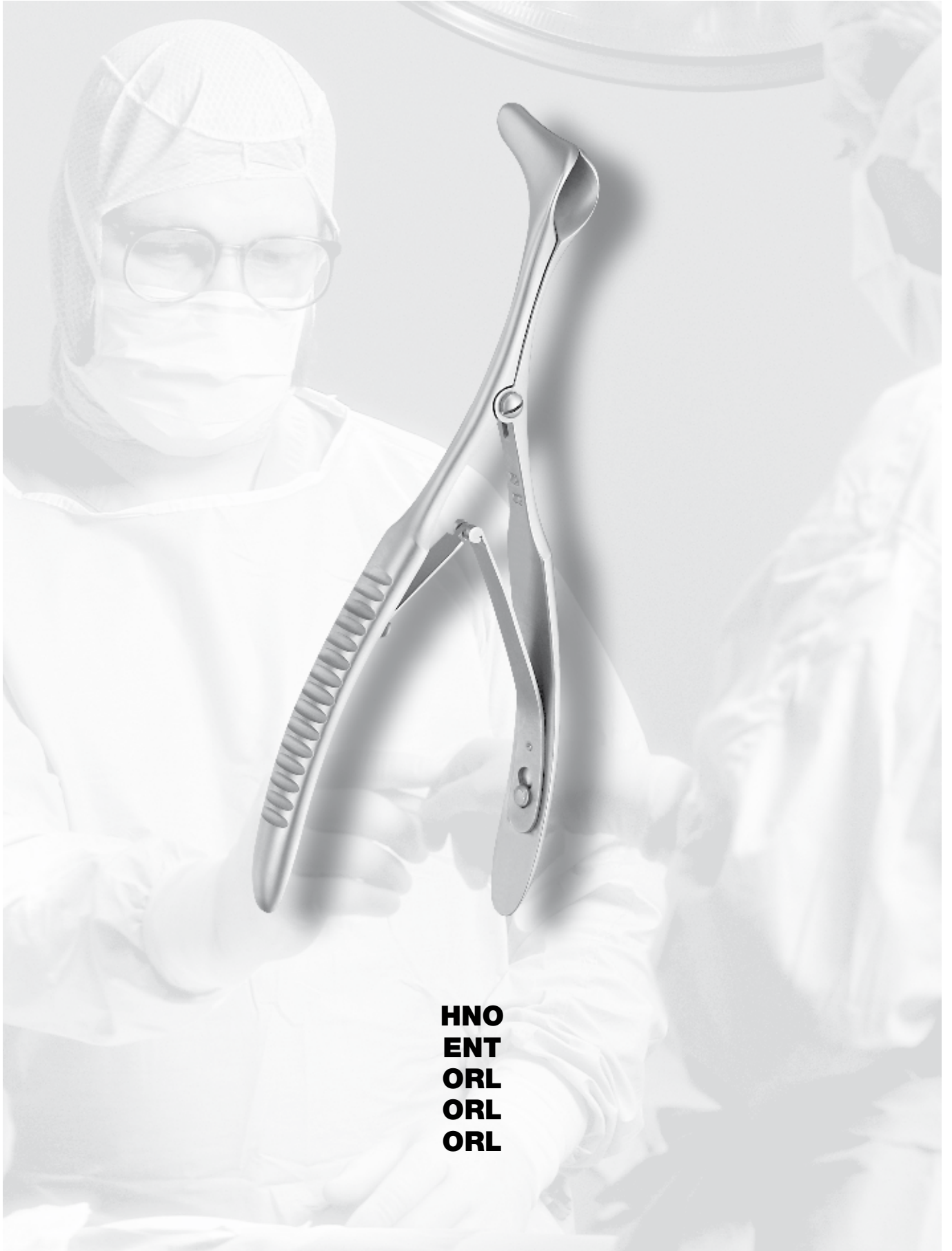

**HNO  
ENT  
ORL  
ORL  
ORL**

**Nasenspekula**  
**Nasal Specula • Espéculos nasales**  
**Spéculums nasaux • Specoli nasali**

---



15 cm – 6"  
**Hartmann-Halle**

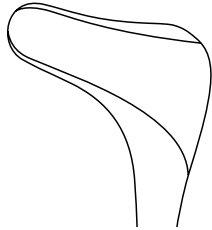

**6630.01**  
# 1

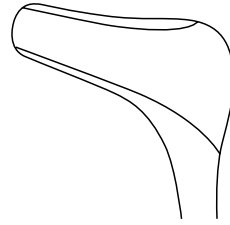

**6630.02**  
# 2

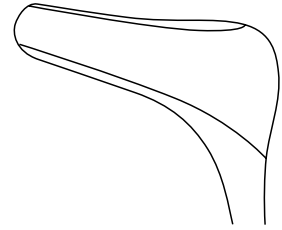

**6630.03**  
# 3



15 cm – 6"  
**Hartmann-Halle**

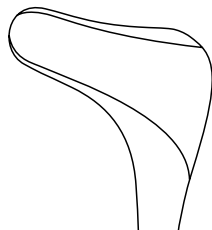

**6630.51**  
# 1

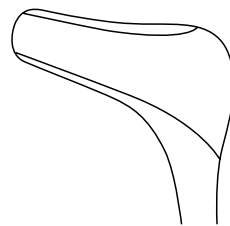

**6630.52**  
# 2

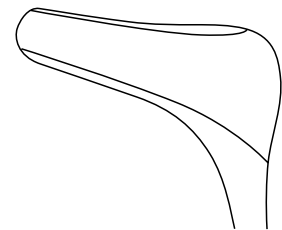

**6630.53**  
# 3

aseptischer Verschluß (zerlegbar)  
aseptic lock (dismantable)  
articulación aséptica (desmontable)  
articulation aseptique (démontable)  
articolazione asettica (smontabile)



**Nasenspekula**  
**Nasal Specula • Espéculos nasales**  
**Spéculums nasaux • Specoli nasali**

---



14 cm – 5½"

**Mod. Wien**

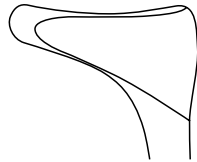

**6650.51**  
# 1

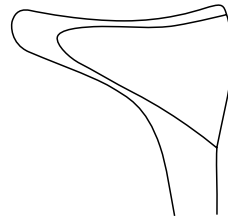

**6650.52**  
# 2

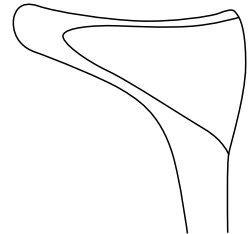

**6650.53**  
# 3



**Nasenspekula**  
**Nasal Specula • Espéculos nasales**  
**Spéculums nasaux • Specoli nasali**

---



14 cm – 5½”  
**Cottle**

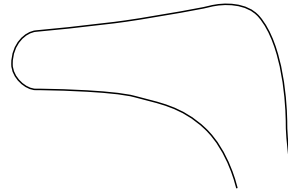

**7620.35**  
#1

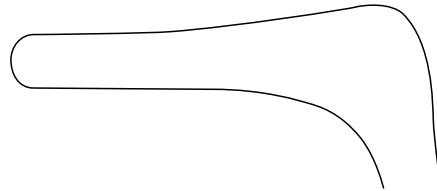

**7620.55**  
#2

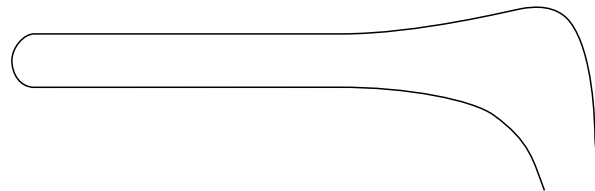

**7620.75**  
#3

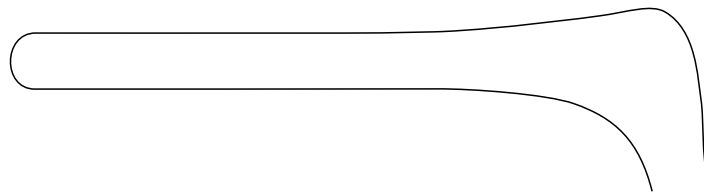

**7620.90**  
#4



**Ohrzängchen**  
**Ear Forceps • Pinza auricular**  
**Pince auriculaire • Pinza auricolare**

---



**2613.12**  
8 cm – 3 $\frac{1}{8}$ "  
**Hartmann**

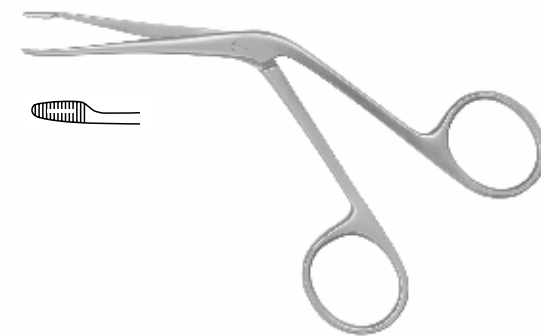

**2603.21**  
13 cm – 5 $\frac{1}{8}$ "  
**Hartmann**



## MCINTOSH

Spatel mit Fiberglas-Lichtleitung  
 Blades with fibre optic light guide  
 Espátulas con conductor de luz fría  
 Spatules à conducteur de lumière en fibres de verre  
 Lame con conduttore d'illuminazione a luce fredda

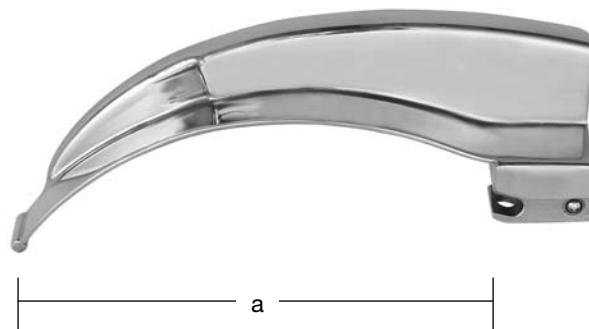

- 5451.60** a = 55 mm Fig. 0
- 5451.61** a = 70 mm Fig. 1
- 5451.62** a = 90 mm Fig. 2
- 5451.63** a = 110 mm Fig. 3
- 5451.64** a = 130 mm Fig. 4

autoklavierbar bis 134°C bei 3 bar  
 autoclavable up to 134°C at 3 bar  
 autoclavable hasta 134°C bajo presión de 3 bar  
 autoclavable jusqu'à 134°C sous pression de 3 bars  
 autoclavabile fino a 134°C sotto pressione di 3 bar

## MCINTOSH

Satz, komplett im Etui  
 Set, complete in case  
 Juego, completo en estuche  
 Jeu complet en étui  
 Set, completo di custodia



**Bestehend aus:**  
**Consisting of:**  
**Composto por:**  
**Composé de:**  
**Composto da:**

	<b>5451.50</b>	<b>5451.51</b>
<b>Spatel</b> <b>Blades</b> <b>Espátulas</b> <b>Spatules</b> <b>Lame</b>	<b>3</b> Fig. 2, 3, 4	<b>4</b> Fig. 1, 2, 3, 4
<b>Standardgriff</b> ohne Batterien <b>Standard handle</b> without batteries <b>Mango estándar</b> sin pilas <b>Manche standard</b> sans piles <b>Manico standard</b> senza pile	2 Batterien werden benötigt 2 batteries needed se necesita 2 pilas 2 piles requises Sono necessari e 2 pile	
	R 14 • Typ C • 1,5 V 5494.92	

**WIS-FOREGGER (WISCONSIN)**

Spatel mit Fiberglas-Lichtleitung  
 Blades with fibre optic light guide  
 Espátulas con conductor de luz fría  
 Spatules à conducteur de lumière en fibres de verre  
 Lame con conduttore d'illuminazione a luce fredda

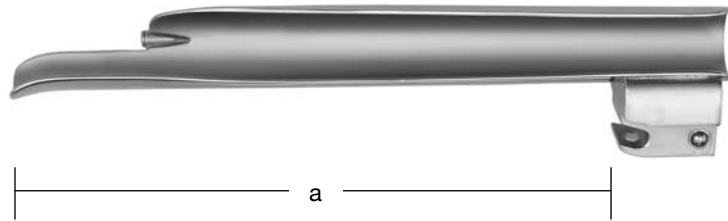

- 5452.60** a = 55 mm Fig. 0
- 5452.61** a = 70 mm Fig. 1
- 5452.62** a = 90 mm Fig. 2
- 5452.63** a = 105 mm Fig. 3
- 5452.64** a = 135 mm Fig. 4

autoklavierbar bis 134°C bei 3 bar  
 autoclavable up to 134°C at 3 bar  
 autoclavable hasta 134°C bajo presión de 3 bar  
 autoclavable jusqu'à 134°C sous pression de 3 bars  
 autoclavabile fino a 134°C sotto pressione di 3 bar

**WIS-FOREGGER (WISCONSIN)**

Satz, komplett im Etui  
 Set, complete in case  
 Juego, completo en estuche  
 Jeu complet en étui  
 Set, completo di custodia



Bestehend aus:  
 Consisting of:  
 Compuesto por:  
 Composé de:  
 Composto da:

	<b>5452.50</b>	<b>5452.51</b>
<b>Spatel</b> <b>Blades</b> <b>Espátulas</b> <b>Spatules</b> <b>Lame</b>	<b>3</b> Fig. 2, 3, 4	<b>4</b> Fig. 1, 2, 3, 4
<b>Standardgriff</b> ohne Batterien <b>Standard handle</b> without batteries <b>Mango estándar</b> sin pilas <b>Manche standard</b> sans piles <b>Manico standard</b> senza pile	2 Batterien werden benötigt 2 batteries needed se necesita 2 pilas 2 piles requises Sono necessari e 2 pile	

R 14 • Typ C • 1,5 V  
 5494.92

**Laryngoskope**  
**Laryngoscopes • Laringoscopios**  
**Laryngoscopes • Laringoscopi**

**MILLER**

Spatel mit Fiberglas-Lichtleitung  
 Blades with fibre optic light guide  
 Espátulas con conductor de luz fría  
 Spatules à conducteur de lumière en fibres de verre  
 Lame con conduttore d'illuminazione a luce fredda

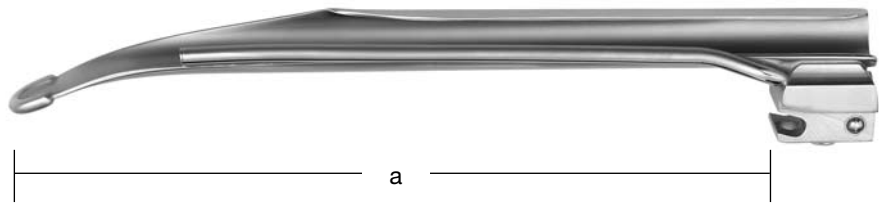

- 5482.60** a = 55 mm Fig. 0
- 5482.61** a = 80 mm Fig. 1
- 5482.62** a = 130 mm Fig. 2
- 5482.63** a = 170 mm Fig. 3
- 5482.64** a = 180 mm Fig. 4

autoklavierbar bis 134°C bei 3 bar  
 autoclavable up to 134°C at 3 bar  
 autoclavable hasta 134°C bajo presión de 3 bar  
 autoclavable jusqu'à 134°C sous pression de 3 bars  
 autoclavabile fino a 134°C sotto pressione di 3 bar

**MILLER**

Satz, komplett im Etui  
 Set, complete in case  
 Juego, completo en estuche  
 Jeu complet en étui  
 Set, completo di custodia



Bestehend aus:  
 Consisting of:  
 Compuesto por:  
 Composé de:  
 Composto da:

Spatel  
 Blades  
 Espátulas  
 Spatules  
 Lame

Standardgriff ohne Batterien  
 Standard handle without batteries  
 Mango estándar sin pilas  
 Manche standard sans piles  
 Manico standard senza pile

**5482.50**

**5482.51**

**3**  
 Fig. 2, 3, 4

**4**  
 Fig. 1, 2, 3, 4

2 Batterien werden benötigt  
 2 batteries needed  
 se necesita 2 pilas  
 2 piles requises  
 Sono necessari e 2 pile

R 14 • Typ C • 1,5 V  
 5494.92



**Laryngoskope**  
**Laryngoscopes • Laringoscopios**  
**Laryngoscopes • Laringoscopi**

---

Griffe für Spatel mit Fiberglas-Lichtleitung  
Handles for blades with fibre optic light guide  
Mangos para espátulas con conductor de luz fría  
Manches pour spatules à conducteur de lumière en fibres de verre  
Manici per lame con conduttore d'illuminazione a luce fredda

standard  
standard  
estándar  
standard  
standard



**5484.49**

schlank  
slim  
fino  
élancé  
sottile



**5484.79**

Halogenlampe  
Halogen lamp  
Lámpara halógena  
Lampe halogène  
Lampadina alogena



**5484.70**

640 mA

für Griffe  
for handles  
para mangos  
pour manches  
per manici

5484.49 + 5484.79

mit Halogenlampe, ohne Batterien  
with halogen lamp, without batteries  
con lámpara halógeno, sin pilas  
avec lampe halogène, sans piles  
con lapadina alogena, senza pile



**Laryngoskope**  
**Laryngoscopes • Laringoscopios**  
**Laryngoscopes • Laringoscopi**

Griff für Spatel mit Fiberglas-Lichtleitung  
Handle for blades with fibre optic light guide  
Mango para espátulas con conductor de luz fría  
Manche pour spatules à conducteur de lumière en fibres de verre  
Manico per lame con conduttore d'illuminazione a luce fredda

Griff mit Leuchtdiode  
Handle with light-emitting diode  
Mango con diodo luminoso  
Manche avec diode électroluminescente  
Manico con diodo luminoso

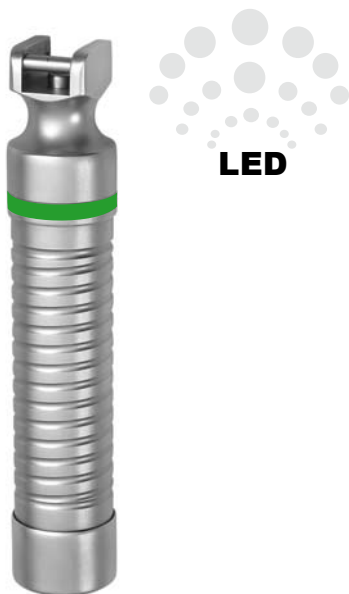

**5484.26**  
3,6 V

mit NiMH-Akku 3,6 V  
with NiMH accumulator 3,6 V  
con acumulador NiMH 3,6 V  
avec accumulateur NiMH 3,6 V  
con accumulatore NiMH 3,6 V

Ladestation  
Charging device  
Cargador  
Chargeur  
Caricatore



**5494.98**  
230 V



nur für Griff 5484.26  
only for handle 5484.26  
solamente para mango 5484.26  
seulement pour manche 5484.26  
solamente per manico 5484.26



**Laryngoskope**  
**Laryngoscopes • Laringoscopios**  
**Laryngoscopes • Laringoscopi**

**MCINTOSH**

Spatel mit Glühlampe  
 Blades with integrated lamp  
 Espátulas con lámpara incandescente  
 Spatules avec lampe  
 Lame con lampadina



**5484.65**  
Fig. 0



**5484.66**  
Fig. 1 - 5

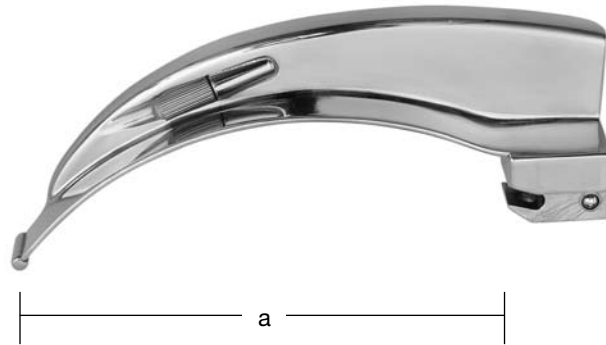

Ersatzlampen  
 Replacement lamps  
 Lámparas de repuesto  
 Lampes de rechange  
 Lampadine di ricambio

- 5410.10** a = 55 mm Fig. 0
- 5410.11** a = 70 mm Fig. 1
- 5410.12** a = 90 mm Fig. 2
- 5410.13** a = 110 mm Fig. 3
- 5410.14** a = 130 mm Fig. 4
- 5410.15** a = 150 mm Fig. 5

autoklavierbar bis 134°C bei 3 bar  
 autoclavable up to 134°C at 3 bar  
 autoclavable hasta 134°C bajo presión de 3 bar  
 autoclavable jusqu'à 134°C sous pression de 3 bars  
 autoclavabile fino a 134°C sotto pressione di 3 bar

**MCINTOSH**

Satz, komplett im Etui  
 Set, complete in case  
 Juego, completo en estuche  
 Jeu complet en étui  
 Set, completo di custodia



Bestehend aus:  
 Consisting of:  
 Compuesto por:  
 Composé de:  
 Composto da:

	<b>5410.00</b>	<b>5410.05</b>
Spatel Blades Espátulas Spatules Lame	<b>3</b> Fig. 2, 3, 4	<b>4</b> Fig. 1, 2, 3, 4
Standardgriff ohne Batterien Standard handle without batteries Mango estándar sin pilas Manche standard sans piles Manico standard senza pile	2 Batterien werden benötigt 2 batteries needed se necesita 2 pilas 2 piles requises Sono necessari e 2 pile	

R 14 • Typ C • 1,5 V  
5494.92

**WIS-FOREGGER (WISCONSIN)**

Spatel mit Glühlampe  
 Blades with integrated lamp  
 Espátulas con lámpara incandescente  
 Spatules avec lampe  
 Lame con lampadina



**5484.65**  
Fig. 0 - 2



**5484.66**  
Fig. 3 - 4

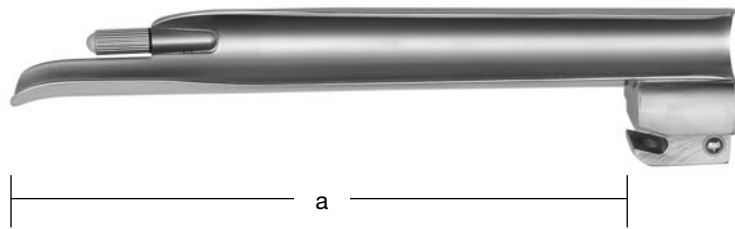

Ersatzlampen  
 Replacement lamps  
 Lámparas de repuesto  
 Lampes de rechange  
 Lampadine di ricambio

- 5450.10** a = 55 mm Fig. 0
- 5450.11** a = 70 mm Fig. 1
- 5450.12** a = 90 mm Fig. 2
- 5450.13** a = 105 mm Fig. 3
- 5450.14** a = 135 mm Fig. 4

autoklavierbar bis 134°C bei 3 bar  
 autoclavable up to 134°C at 3 bar  
 autoclavable hasta 134°C bajo presión de 3 bar  
 autoclavable jusqu'à 134°C sous pression de 3 bars  
 autoclavabile fino a 134°C sotto pressione di 3 bar

**WIS-FOREGGER (WISCONSIN)**

Satz, komplett im Etui  
 Set, complete in case  
 Juego, completo en estuche  
 Jeu complet en étui  
 Set, completo di custodia



Bestehend aus:  
 Consisting of:  
 Compuesto por:  
 Composé de:  
 Composto da:

	<b>5450.50</b>	<b>5450.51</b>
Spatel Blades Espátulas Spatules Lame	<b>3</b> Fig. 2, 3, 4	<b>4</b> Fig. 1, 2, 3, 4
Standardgriff ohne Batterien Standard handle without batteries Mango estándar sin pilas Manche standard sans piles Manico standard senza pile	2 Batterien werden benötigt 2 batteries needed se necesita 2 pilas 2 piles requises Sono necessari e 2 pile	

R 14 • Typ C • 1,5 V  
5494.92



**Laryngoskope**  
**Laryngoscopes • Laringoscopios**  
**Laryngoscopes • Laringoscopi**

**MILLER**

Spatel mit Glühlampe  
 Blades with integrated lamp  
 Espátulas con lámpara incandescente  
 Spatules avec lampe  
 Lame con lampadina



**5484.65**  
Fig. 0 - 3



**5484.66**  
Fig. 4



Ersatzlampen  
 Replacement lamps  
 Lámparas de repuesto  
 Lampes de rechange  
 Lampadine di ricambio

- 5480.30** a = 55 mm Fig. 0
- 5480.31** a = 80 mm Fig. 1
- 5480.32** a = 130 mm Fig. 2
- 5480.33** a = 170 mm Fig. 3
- 5480.34** a = 180 mm Fig. 4

autoklavierbar bis 134°C bei 3 bar  
 autoclavable up to 134°C at 3 bar  
 autoclavable hasta 134°C bajo presión de 3 bar  
 autoclavable jusqu'à 134°C sous pression de 3 bars  
 autoclavabile fino a 134°C sotto pressione di 3 bar

**MILLER**

Satz, komplett im Etui  
 Set, complete in case  
 Juego, completo en estuche  
 Jeu complet en étui  
 Set, completo di custodia



Bestehend aus:  
 Consisting of:  
 Compuesto por:  
 Composé de:  
 Composto da:

	<b>5480.50</b>	<b>5480.51</b>
Spatel Blades Espátulas Spatules Lame	<b>3</b> Fig. 2, 3, 4	<b>4</b> Fig. 1, 2, 3, 4
Standardgriff ohne Batterien Standard handle without batteries Mango estándar sin pilas Manche standard sans piles Manico standard senza pile	2 Batterien werden benötigt 2 batteries needed se necesita 2 pilas 2 piles requises Sono necessari e 2 pile	

R 14 • Typ C • 1,5 V  
5494.92





**Laryngoskope**  
**Laryngoscopes • Laringoscopios**  
**Laryngoscopes • Laringoscopi**

Griffe für Spatel mit Glühlampe  
Handles for blades with integrated lamp  
Mangos para espátulas con lámpara incandescente  
Manches pour spatules avec lampe  
Manici per lame con lampadina

standard  
standard  
estándar  
standard  
standard



**5484.12**

schlank  
slim  
fino  
élançé  
sottile



**5484.11**

mit Trafoanschluß  
with transformer connection  
con conexión para transformador  
avec connexion de transformateur  
con raccordo per trasformatore



**5484.15**



Trafo für:  
Transformer for:  
Transformador para:  
Transformateur pour:  
Trasformatore per:  
5484.15



**5484.17**  
230 V

ohne Batterien  
without batteries  
sin pilas  
sans piles  
senza pile

ohne Akku  
without accumulator  
sin acumulador  
sans accumulateur  
senza accumulatore

## Laryngoskope Laryngoscopes • Laringoscopios Laryngoscopes • Laringoscopi

Zubehör für Laryngoskope  
Accessories for laryngoscopes  
Accesorios para laringoscopios  
Accessoires pour laryngoscopes  
Accessori per laringoscopi

Batterien  
Batteries  
Pilas  
Piles  
Batterie

2 Batterien werden benötigt  
2 batteries needed  
se necesita 2 pilas  
2 piles requises  
Sono necessari 2 pile

standard  
standard  
estándar  
standard  
standard



**5494.92**  
R14 (1,5 V)  
Baby C

schlank  
slim  
fino  
élancé  
sottile



**5494.91**  
R6 (1,5 V)  
Mignon AA

Akkumulator  
Accumulator  
Acumulador  
Accumulateur  
Accumulatore

2 Akkus werden benötigt  
2 accumulators needed  
se necesita 2 acumuladores  
2 accumulateurs requises  
Sono necessari 2 accumulatori



**5494.93**  
Baby C (1,2 V)  
Ni-MH

für Standardgriffe  
for standard handles  
para mangos estándar  
pour manches standard  
per manici standard

Ladegerät für Akkumulatoren  
Charging device for accumulators  
Cargador para acumuladores  
Chargeur pour accumulateurs  
Ricaricatori per accumulatori

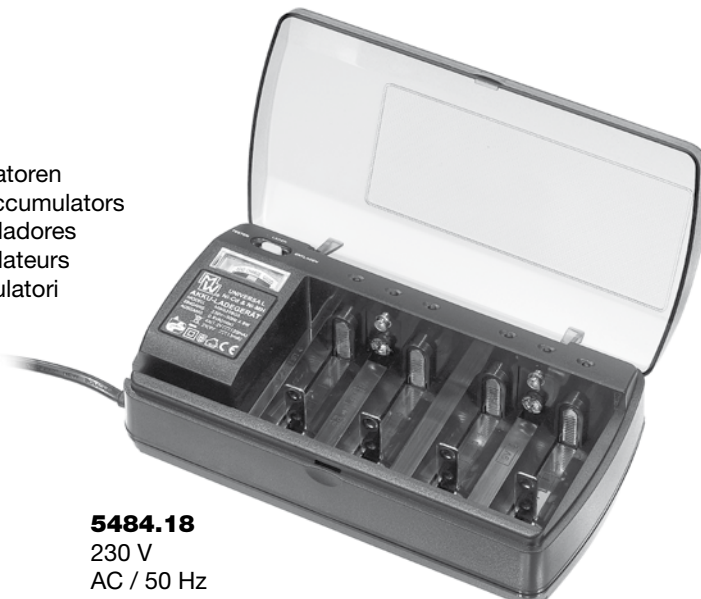

**5484.18**  
230 V  
AC / 50 Hz

für NiCd / NiMH Akkus  
for NiCd / NiMH accumulators  
para acumuladores NiCd / NiMH  
pour accumulateurs NiCd / NiMH  
per accumulatori NiCd / NiMH

**1-4**  
Micro AAA  
Mignon AA  
Baby C  
Mono D

**1-2**  
9 V



## Nummerisches Inhaltsverzeichnis Numerical Index • Índice numérico Index numérique • Índice numerico

<b>Kat. Nr.</b> <b>Cat. No.</b> <b>No. Cat.</b> <b>No. Cat.</b> <b>No. Cat.</b>	Seite page página page pagina	<b>Kat. Nr.</b> <b>Cat. No.</b> <b>No. Cat.</b> <b>No. Cat.</b> <b>No. Cat.</b>	Seite page página page pagina	<b>Kat. Nr.</b> <b>Cat. No.</b> <b>No. Cat.</b> <b>No. Cat.</b> <b>No. Cat.</b>	Seite page página page pagina
<b>0101.12</b>	45	<b>0203.19</b>	93	<b>0455.23</b>	120
<b>0101.13</b>	46	<b>0203.20</b>	93	<b>0455.26</b>	120
<b>0101.62</b>	45	<b>0205.01</b>	94	<b>0455.37</b>	120
<b>0101.63</b>	46	<b>0205.02</b>	94	<b>0457.23</b>	119
<b>0102.14</b>	49	<b>0205.05</b>	94	<b>0501.16</b>	129
<b>0102.15</b>	49	<b>0205.07</b>	94	<b>0501.20</b>	129
<b>0102.18</b>	49	<b>0205.10</b>	94	<b>0501.23</b>	129
<b>0102.20</b>	49	<b>0246.01</b>	95	<b>0511.16</b>	129
<b>0102.64</b>	50	<b>0246.02</b>	95	<b>0511.20</b>	129
<b>0102.65</b>	50	<b>0246.03</b>	95	<b>0520.13</b>	128
<b>0102.68</b>	50	<b>0246.04</b>	95	<b>0520.15</b>	128
<b>0102.70</b>	50	<b>0250.08</b>	92	<b>0520.16</b>	128
<b>0102.73</b>	50	<b>0250.09</b>	92	<b>0520.19</b>	128
<b>0106.14</b>	51	<b>0256.01</b>	95	<b>0522.23</b>	130
<b>0106.17</b>	51	<b>0256.02</b>	95	<b>0522.26</b>	130
<b>0106.64</b>	51	<b>0256.03</b>	95	<b>0522.28</b>	130
<b>0106.67</b>	51	<b>0256.04</b>	95	<b>0532.23</b>	131
<b>0121.12</b>	46	<b>0303.15</b>	113	<b>0532.26</b>	131
<b>0121.13</b>	47	<b>0350.14</b>	113	<b>0532.28</b>	131
<b>0121.62</b>	46	<b>0352.30</b>	113	<b>0537.05</b>	132
<b>0121.63</b>	47	<b>0352.45</b>	113	<b>0537.20</b>	132
<b>0141.14</b>	47	<b>0352.90</b>	113	<b>0539.90</b>	133
<b>0141.64</b>	47	<b>0407.27</b>	119	<b>0577.72</b>	133
<b>0180.62</b>	45	<b>0413.20</b>	118	<b>0577.73</b>	133
<b>0181.15</b>	48	<b>0414.23</b>	118	<b>0650.10</b>	106
<b>0181.18</b>	48	<b>0418.18</b>	119	<b>0650.11</b>	106
<b>0181.20</b>	48	<b>0418.24</b>	119	<b>0650.12</b>	106
<b>0181.24</b>	48	<b>0433.23</b>	118	<b>0650.13</b>	106
<b>0181.65</b>	48	<b>0452.11</b>	118	<b>0650.14</b>	106
<b>0181.68</b>	48	<b>0452.14</b>	118	<b>1022.10</b>	2
<b>0181.70</b>	48	<b>0452.18</b>	118	<b>1022.11</b>	2
<b>0181.74</b>	48	<b>0452.20</b>	118	<b>1022.15</b>	2

## Nummerisches Inhaltsverzeichnis Numerical Index • Índice numérico Index numérique • Indice numerico

<b>1022.20</b>	2	<b>2012.09</b>	7	<b>2504.01</b>	141
<b>1022.23</b>	2	<b>2012.10</b>	7	<b>2504.11</b>	141
<b>1022.24</b>	2	<b>2012.11</b>	7	<b>2505.01</b>	143
<b>1072.03</b>	3	<b>2012.30</b>	7	<b>2505.02</b>	143
<b>1072.07</b>	3	<b>2014.12</b>	8	<b>2510.00</b>	140
<b>1072.13</b>	3	<b>2060.02</b>	6	<b>2510.02</b>	140
<b>1082.04</b>	3	<b>2060.12</b>	6	<b>2510.03</b>	140
<b>1082.14</b>	3	<b>2060.32</b>	6	<b>2510.04</b>	140
<b>1102.14</b>	52	<b>2070.02</b>	6	<b>2518.00</b>	144
<b>1102.17</b>	52	<b>2070.12</b>	6	<b>2518.10</b>	144
<b>1102.20</b>	52	<b>2070.32</b>	6	<b>2518.11</b>	144
<b>1102.64</b>	52	<b>2201.12</b>	96	<b>2518.12</b>	144
<b>1102.67</b>	52	<b>2201.15</b>	96	<b>2518.13</b>	144
<b>1102.70</b>	52	<b>2241.13</b>	97	<b>2518.14</b>	144
<b>1303.23</b>	115	<b>2241.18</b>	97	<b>2518.15</b>	144
<b>1311.04</b>	114	<b>2243.01</b>	99	<b>2518.16</b>	144
<b>1311.05</b>	114	<b>2243.02</b>	99	<b>2518.17</b>	144
<b>1313.23</b>	115	<b>2243.03</b>	99	<b>2518.18</b>	144
<b>1370.05</b>	114	<b>2243.04</b>	99	<b>2518.19</b>	144
<b>1541.06</b>	136	<b>2243.06</b>	99	<b>2518.20</b>	144
<b>1541.07</b>	136	<b>2243.51</b>	100	<b>2518.50</b>	144
<b>1557.05</b>	138	<b>2243.52</b>	100	<b>2518.51</b>	144
<b>1557.10</b>	138	<b>2243.53</b>	100	<b>2518.52</b>	144
<b>1585.01</b>	137	<b>2243.54</b>	100	<b>2518.53</b>	144
<b>1585.02</b>	137	<b>2243.56</b>	100	<b>2518.54</b>	144
<b>1585.03</b>	137	<b>2253.01</b>	101	<b>2518.55</b>	144
<b>1585.04</b>	137	<b>2253.02</b>	101	<b>2518.56</b>	144
<b>2002.09</b>	7	<b>2253.03</b>	101	<b>2518.57</b>	144
<b>2002.10</b>	7	<b>2253.04</b>	101	<b>2518.58</b>	144
<b>2002.11</b>	7	<b>2253.06</b>	101	<b>2518.59</b>	144
<b>2002.30</b>	7	<b>2261.00</b>	98	<b>2518.60</b>	144
<b>2004.12</b>	8	<b>2261.14</b>	98	<b>2528.00</b>	145
<b>2005.02</b>	8	<b>2261.15</b>	98	<b>2528.10</b>	145
<b>2005.03</b>	8	<b>2261.16</b>	98	<b>2528.11</b>	145
<b>2005.12</b>	8	<b>2281.21</b>	98	<b>2528.12</b>	145
<b>2005.13</b>	8	<b>2502.00</b>	141	<b>2528.13</b>	145

## Nummerisches Inhaltsverzeichnis Numerical Index • Índice numérico Index numérique • Indice numerico

<b>2528.14</b>	145	<b>2586.80</b>	150	<b>3050.15</b>	11
<b>2528.15</b>	145	<b>2603.21</b>	161	<b>3050.16</b>	11
<b>2528.16</b>	145	<b>2613.12</b>	161	<b>3050.18</b>	11
<b>2528.17</b>	145	<b>3001.15</b>	12	<b>3060.10</b>	10
<b>2528.18</b>	145	<b>3005.14</b>	13	<b>3060.11</b>	10
<b>2528.19</b>	145	<b>3005.17</b>	13	<b>3060.13</b>	10
<b>2528.20</b>	145	<b>3005.23</b>	13	<b>3060.14</b>	10
<b>2528.50</b>	145	<b>3011.15</b>	12	<b>3060.15</b>	10
<b>2528.51</b>	145	<b>3015.14</b>	13	<b>3060.16</b>	10
<b>2528.52</b>	145	<b>3015.17</b>	13	<b>3060.18</b>	10
<b>2528.53</b>	145	<b>3015.23</b>	13	<b>3065.15</b>	14
<b>2528.54</b>	145	<b>3020.10</b>	10	<b>3065.17</b>	14
<b>2528.55</b>	145	<b>3020.11</b>	10	<b>3065.86</b>	15
<b>2528.56</b>	145	<b>3020.13</b>	10	<b>3070.10</b>	11
<b>2528.57</b>	145	<b>3020.14</b>	10	<b>3070.11</b>	11
<b>2528.58</b>	145	<b>3020.15</b>	10	<b>3070.13</b>	11
<b>2528.59</b>	145	<b>3020.16</b>	10	<b>3070.14</b>	11
<b>2528.60</b>	145	<b>3020.18</b>	10	<b>3070.15</b>	11
<b>2544.25</b>	142	<b>3030.10</b>	11	<b>3070.16</b>	11
<b>2544.60</b>	142	<b>3030.11</b>	11	<b>3070.18</b>	11
<b>2546.00</b>	148	<b>3030.13</b>	11	<b>3075.15</b>	14
<b>2546.05</b>	148	<b>3030.14</b>	11	<b>3075.17</b>	14
<b>2546.10</b>	149	<b>3030.15</b>	11	<b>3075.86</b>	15
<b>2546.15</b>	149	<b>3030.16</b>	11	<b>3080.14</b>	12
<b>2546.20</b>	150	<b>3030.18</b>	11	<b>3090.14</b>	12
<b>2550.07</b>	140	<b>3040.10</b>	10	<b>3157.12</b>	53
<b>2550.10</b>	140	<b>3040.11</b>	10	<b>3187.12</b>	53
<b>2550.12</b>	140	<b>3040.13</b>	10	<b>3212.18</b>	102
<b>2556.02</b>	146	<b>3040.14</b>	10	<b>3212.20</b>	102
<b>2556.04</b>	146	<b>3040.15</b>	10	<b>3212.25</b>	102
<b>2556.05</b>	147	<b>3040.16</b>	10	<b>3250.10</b>	102
<b>2556.06</b>	147	<b>3040.18</b>	10	<b>3250.14</b>	102
<b>2556.07</b>	147	<b>3050.10</b>	11	<b>3250.16</b>	102
<b>2560.07</b>	140	<b>3050.11</b>	11	<b>3257.01</b>	103
<b>2560.10</b>	140	<b>3050.13</b>	11	<b>3257.02</b>	103
<b>2560.12</b>	140	<b>3050.14</b>	11	<b>3257.03</b>	103

## Nummerisches Inhaltsverzeichnis Numerical Index • Índice numérico Index numérique • Indice numerico

<b>3257.04</b>	104	<b>4033.11</b>	17	<b>5103.79</b>	56
<b>3257.05</b>	104	<b>4033.14</b>	17	<b>5104.12</b>	56
<b>3257.06</b>	104	<b>4033.18</b>	17	<b>5107.14</b>	60
<b>3257.07</b>	105	<b>4033.20</b>	17	<b>5107.16</b>	60
<b>3257.08</b>	105	<b>4033.23</b>	18	<b>5113.09</b>	56
<b>3257.09</b>	105	<b>4033.26</b>	18	<b>5113.79</b>	56
<b>3302.14</b>	116	<b>4043.14</b>	19	<b>5114.12</b>	56
<b>3302.17</b>	116	<b>4043.18</b>	19	<b>5117.14</b>	60
<b>3312.14</b>	116	<b>4045.16</b>	9	<b>5117.16</b>	60
<b>3312.17</b>	116	<b>4053.14</b>	19	<b>5123.09</b>	57
<b>3407.83</b>	122	<b>4053.18</b>	19	<b>5124.12</b>	56
<b>3437.13</b>	122	<b>4055.16</b>	9	<b>5127.14</b>	61
<b>3454.00</b>	123	<b>4132.12</b>	21	<b>5127.16</b>	61
<b>3457.14</b>	122	<b>4142.12</b>	21	<b>5133.09</b>	57
<b>3477.84</b>	122	<b>4152.12</b>	21	<b>5134.12</b>	56
<b>3487.13</b>	123	<b>4160.09</b>	20	<b>5137.14</b>	61
<b>3503.15</b>	152	<b>4160.10</b>	20	<b>5137.16</b>	61
<b>3505.05</b>	154	<b>4160.12</b>	20	<b>5144.12</b>	58
<b>3505.10</b>	154	<b>4160.13</b>	20	<b>5144.14</b>	58
<b>3505.25</b>	155	<b>4162.10</b>	21	<b>5154.12</b>	58
<b>3505.50</b>	155	<b>4172.10</b>	21	<b>5154.14</b>	58
<b>3505.51</b>	155	<b>4204.14</b>	109	<b>5164.12</b>	58
<b>3505.60</b>	156	<b>4207.01</b>	110	<b>5165.15</b>	59
<b>3505.65</b>	156	<b>4207.10</b>	110	<b>5167.13</b>	62
<b>3513.18</b>	152	<b>4207.15</b>	110	<b>5167.14</b>	62
<b>3526.11</b>	153	<b>4207.17</b>	110	<b>5167.16</b>	62
<b>3526.16</b>	153	<b>4222.10</b>	108	<b>5167.18</b>	62
<b>3551.22</b>	152	<b>4222.11</b>	108	<b>5167.20</b>	62
<b>4008.13</b>	9	<b>4222.13</b>	108	<b>5174.12</b>	58
<b>4018.13</b>	9	<b>4222.14</b>	108	<b>5175.15</b>	59
<b>4023.11</b>	16	<b>4222.16</b>	108	<b>5177.13</b>	63
<b>4023.14</b>	16	<b>4222.17</b>	108	<b>5177.14</b>	63
<b>4023.18</b>	16	<b>4223.04</b>	109	<b>5177.16</b>	63
<b>4023.20</b>	16	<b>4421.05</b>	126	<b>5177.18</b>	63
<b>4023.23</b>	18	<b>4470.50</b>	126	<b>5177.20</b>	63
<b>4023.26</b>	18	<b>5103.09</b>	56	<b>5182.14</b>	57

## Nummerisches Inhaltsverzeichnis Numerical Index • Índice numérico Index numérique • Índice numerico

<b>5185.15</b>	59	<b>5480.31</b>	169	<b>6000.30</b>	24
<b>5192.14</b>	57	<b>5480.32</b>	169	<b>6002.01</b>	26
<b>5195.15</b>	59	<b>5480.33</b>	169	<b>6002.05</b>	26
<b>5410.00</b>	167	<b>5480.34</b>	169	<b>6002.12</b>	26
<b>5410.05</b>	167	<b>5480.50</b>	169	<b>6003.12</b>	28
<b>5410.10</b>	167	<b>5480.51</b>	169	<b>6003.15</b>	28
<b>5410.11</b>	167	<b>5482.50</b>	164	<b>6003.22</b>	28
<b>5410.12</b>	167	<b>5482.51</b>	164	<b>6003.25</b>	28
<b>5410.13</b>	167	<b>5482.60</b>	164	<b>6004.15</b>	27
<b>5410.14</b>	167	<b>5482.61</b>	164	<b>6004.85</b>	27
<b>5410.15</b>	167	<b>5482.62</b>	164	<b>6005.15</b>	30
<b>5450.10</b>	168	<b>5482.63</b>	164	<b>6005.19</b>	30
<b>5450.11</b>	168	<b>5482.64</b>	164	<b>6005.24</b>	30
<b>5450.12</b>	168	<b>5484.11</b>	170	<b>6006.17</b>	32
<b>5450.13</b>	168	<b>5484.12</b>	170	<b>6006.18</b>	32
<b>5450.14</b>	168	<b>5484.15</b>	170	<b>6006.87</b>	32
<b>5450.50</b>	168	<b>5484.17</b>	170	<b>6006.88</b>	32
<b>5450.51</b>	168	<b>5484.18</b>	171	<b>6006.90</b>	32
<b>5451.50</b>	162	<b>5484.26</b>	166	<b>6006.92</b>	32
<b>5451.51</b>	162	<b>5484.49</b>	165	<b>6012.12</b>	26
<b>5451.60</b>	162	<b>5484.65</b>	167-169	<b>6013.12</b>	28
<b>5451.61</b>	162	<b>5484.66</b>	167-169	<b>6013.15</b>	28
<b>5451.62</b>	162	<b>5484.70</b>	165	<b>6013.22</b>	28
<b>5451.63</b>	162	<b>5484.79</b>	165	<b>6013.25</b>	28
<b>5451.64</b>	162	<b>5494.91</b>	171	<b>6022.12</b>	26
<b>5452.50</b>	163	<b>5494.92</b>	171	<b>6022.15</b>	26
<b>5452.51</b>	163	<b>5494.93</b>	171	<b>6025.15</b>	30
<b>5452.60</b>	163	<b>5494.98</b>	166	<b>6025.19</b>	30
<b>5452.61</b>	163	<b>6000.10</b>	24	<b>6025.24</b>	30
<b>5452.62</b>	163	<b>6000.11</b>	24	<b>6032.12</b>	26
<b>5452.63</b>	163	<b>6000.13</b>	24	<b>6032.15</b>	26
<b>5452.64</b>	163	<b>6000.14</b>	24	<b>6045.15</b>	31
<b>5457.01</b>	126	<b>6000.16</b>	24	<b>6045.19</b>	31
<b>5457.02</b>	126	<b>6000.18</b>	24	<b>6045.24</b>	31
<b>5457.03</b>	126	<b>6000.20</b>	24	<b>6045.30</b>	31
<b>5480.30</b>	169	<b>6000.25</b>	24	<b>6050.10</b>	25



## Nummerisches Inhaltsverzeichnis Numerical Index • Índice numérico Index numérique • Indice numerico

<b>6050.11</b>	25	<b>6111.24</b>	65	<b>6156.72</b>	75
<b>6050.13</b>	25	<b>6111.26</b>	65	<b>6156.73</b>	75
<b>6050.14</b>	25	<b>6111.84</b>	67	<b>6156.76</b>	75
<b>6050.16</b>	25	<b>6111.86</b>	67	<b>6156.77</b>	75
<b>6050.18</b>	25	<b>6111.94</b>	67	<b>6156.78</b>	75
<b>6050.20</b>	25	<b>6114.18</b>	70	<b>6160.14</b>	59
<b>6050.25</b>	25	<b>6115.20</b>	70	<b>6160.16</b>	59
<b>6050.30</b>	25	<b>6115.21</b>	70	<b>6165.20</b>	72
<b>6052.12</b>	27	<b>6121.14</b>	66	<b>6174.19</b>	71
<b>6052.15</b>	27	<b>6121.16</b>	68	<b>6175.20</b>	72
<b>6055.19</b>	31	<b>6121.18</b>	68	<b>6175.26</b>	72
<b>6055.24</b>	31	<b>6121.20</b>	68	<b>6185.20</b>	72
<b>6055.30</b>	31	<b>6121.22</b>	68	<b>6195.20</b>	72
<b>6064.18</b>	29	<b>6121.24</b>	68	<b>6195.26</b>	72
<b>6064.20</b>	29	<b>6121.26</b>	68	<b>6630.01</b>	158
<b>6064.25</b>	29	<b>6131.14</b>	66	<b>6630.02</b>	158
<b>6084.18</b>	29	<b>6131.16</b>	69	<b>6630.03</b>	158
<b>6084.20</b>	29	<b>6131.18</b>	69	<b>6630.51</b>	158
<b>6084.25</b>	29	<b>6131.20</b>	69	<b>6630.52</b>	158
<b>6101.13</b>	66	<b>6131.22</b>	69	<b>6630.53</b>	158
<b>6101.14</b>	66	<b>6131.24</b>	69	<b>6650.51</b>	159
<b>6101.16</b>	64	<b>6131.26</b>	69	<b>6650.52</b>	159
<b>6101.18</b>	64	<b>6141.72</b>	71	<b>6650.53</b>	159
<b>6101.20</b>	64	<b>6146.18</b>	73	<b>7003.14</b>	34
<b>6101.22</b>	64	<b>6146.20</b>	73	<b>7003.16</b>	34
<b>6101.24</b>	64	<b>6146.21</b>	73	<b>7003.19</b>	34
<b>6101.26</b>	64	<b>6146.22</b>	73	<b>7009.11</b>	37
<b>6101.86</b>	67	<b>6151.72</b>	71	<b>7019.14</b>	37
<b>6104.18</b>	70	<b>6156.13</b>	74	<b>7019.24</b>	37
<b>6105.20</b>	70	<b>6156.19</b>	75	<b>7028.07</b>	36
<b>6111.13</b>	66	<b>6156.21</b>	75	<b>7028.09</b>	36
<b>6111.14</b>	66	<b>6156.22</b>	75	<b>7028.11</b>	36
<b>6111.16</b>	65	<b>6156.27</b>	75	<b>7048.11</b>	36
<b>6111.18</b>	65	<b>6156.28</b>	75	<b>7048.21</b>	36
<b>6111.20</b>	65	<b>6156.70</b>	75	<b>7049.14</b>	37
<b>6111.22</b>	65	<b>6156.71</b>	75	<b>7051.15</b>	33

## Nummerisches Inhaltsverzeichnis Numerical Index • Índice numérico Index numérique • Indice numerico

<b>7051.20</b>	33	<b>7180.23</b>	77	<b>9215.52</b>	112
<b>7051.25</b>	33	<b>7620.35</b>	160	<b>9215.53</b>	112
<b>7053.13</b>	34	<b>7620.55</b>	160	<b>9215.54</b>	112
<b>7103.14</b>	79	<b>7620.75</b>	160	<b>9215.55</b>	112
<b>7103.15</b>	79	<b>7620.90</b>	160	<b>9215.56</b>	112
<b>7105.18</b>	80	<b>9038.26</b>	40	<b>23301.20</b>	35
<b>7111.19</b>	74	<b>9038.28</b>	40	<b>23301.22</b>	35
<b>7112.50</b>	78	<b>9038.30</b>	40	<b>23302.10</b>	35
<b>7112.51</b>	78	<b>9038.32</b>	40	<b>23302.20</b>	35
<b>7112.55</b>	78	<b>9058.00</b>	41	<b>23351.20</b>	35
<b>7112.56</b>	78	<b>9078.30</b>	41		
<b>7123.16</b>	79	<b>9088.23</b>	41		
<b>7127.16</b>	82	<b>9105.18</b>	86		
<b>7127.18</b>	82	<b>9105.24</b>	86		
<b>7127.75</b>	81	<b>9108.26</b>	88		
<b>7127.76</b>	81	<b>9115.18</b>	86		
<b>7127.78</b>	81	<b>9115.24</b>	86		
<b>7127.79</b>	81	<b>9118.26</b>	88		
<b>7127.80</b>	81	<b>9125.24</b>	87		
<b>7127.81</b>	81	<b>9128.26</b>	89		
<b>7143.15</b>	79	<b>9135.24</b>	87		
<b>7143.20</b>	79	<b>9141.20</b>	84		
<b>7150.14</b>	76	<b>9141.26</b>	84		
<b>7150.19</b>	76	<b>9151.20</b>	84		
<b>7155.08</b>	80	<b>9151.26</b>	84		
<b>7155.10</b>	80	<b>9160.13</b>	84		
<b>7155.13</b>	80	<b>9160.15</b>	84		
<b>7155.15</b>	80	<b>9161.20</b>	85		
<b>7160.14</b>	76	<b>9161.26</b>	85		
<b>7160.19</b>	76	<b>9171.20</b>	85		
<b>7170.18</b>	77	<b>9171.26</b>	85		
<b>7170.23</b>	77	<b>9215.24</b>	112		
<b>7175.10</b>	80	<b>9215.33</b>	112		
<b>7175.14</b>	80	<b>9215.42</b>	112		
<b>7180.14</b>	77	<b>9215.50</b>	112		
<b>7180.18</b>	77	<b>9215.51</b>	112		



---

best of basic instruments

## Alphabetischer Index

<b>A</b>			
ADSON-BABY			
Präparier- und Ligaturklemmen	76		
ADSON-BROWN feine Pinzetten	27		
ADSON feine Pinzetten	26		
ADSON HALSTED Arterienklemmen	70		
ADSON MICRO feine Pinzetten	26		
Akkumulator für Laryngoskopgriffe	171		
ALLIS-BABY			
Darm- und Gewebefaßzange	128		
ALLIS			
Darm- und Gewebefaßzangen	128		
Anatomische Pinzetten	24, 29, 32		
ARMYTAGE GREEN			
Uterusklemmzange	152		
Arterienklemmen	56-72, 78-79		
Atraumatische Pinzetten	30-31		
<b>B</b>			
BABCOCK			
Darm- und Gewebefaßzangen	129		
BABY ADSON			
Präparier- und Ligaturklemmen	76		
BABY ALLIS			
Darm- und Gewebefaßzange	128		
BABY BALFOUR			
Bauchdeckenhalter	110		
BABY CRILE-WOOD			
Nadelhalter	49, 50		
BABY FARABEUW Wundhaken	96		
BABY GELPI Wundspreizer	109		
BABY-METZENBAUM			
Präparierscheren	16, 17		
BABY MIXTER			
Präparier- und Ligaturklemmen	76		
BABY-MOSQUITO HARTMANN			
Arterienklemmen	57		
BABY-OVERHOLT			
Präparier- und Ligaturklemme	74		
BABY PEAN Arterienklemmen	57		
BABY-TISCHLER			
Biopsiezange Gyn.	149		
BACKHAUS Tuchklemmen	80		
Bajonett Pinzetten	34		
BALFOUR-BABY			
Bauchdeckenhalter	110		
BALFOUR Bauchdeckenhalter	110		
BALLENGER FOERSTER			
Schwammzangen	86		
Batterien für Laryngoskopgriffe	171		
Bauchdeckenhalter	110		
BAUMGARTNER Nadelhalter	47		
BECKMANN Wundspreizer	109		
BEEBEE Drahtscheren	21		
BENGOLEA Arterienklemmen	72		
BERGMANN Verbandschere	118		
BEYER Hohlmeißelzange	114		
Biopsiezangen Gyn.	146-150		
BIRKETT Arterienklemme	71		
BLUMENTHAL Hohlmeißelzangen	113		
BOEHLER WOLFF			
Gipsabreißzangen	119		
BOETTCHER SCHNIDT			
Arterien- und Tonsillenklemmen	78		
BOZEMANN-DOUGLAS			
Tamponzange	89		
BOZEMANN Tamponzangen	88		
BRAUN SIMPSON Geburtszange	155		
BRAUN-STADLER Dammschere	152		
BROWN ADSON feine Pinzetten	27		
BRUNS Verbandschere	118		
BUCK Diagnostik Hammer	126		
BURKE Biopsiezange Gyn.	148		
BUSCH Nabelschnurschere	153		
<b>C</b>			
CHAPUT			
Arterien- und Gewebefaßklemme	79		
Chirurgische Pinzetten	25, 29, 32		
Chirurgische Scheren	10-12		
COLLEGE LONDON Zahnpinzetten	35		
COLLIN			
Arterien- und Gewebefaßklemme	79		
COTTLE Nasenspekula	160		
CRILE Arterienklemmen	61		
CRILE-RANKIN Arterienklemmen	61		
CRILE-WOOD BABY			
Nadelhalter	49, 50		
CRILE-WOOD Nadelhalter	49, 50		
CUSCO Scheidenspekula	140		
CUSHING anatomische Pinzetten	32		
CUSHING chirurgische Pinzetten	32		
<b>D</b>			
Dammscheren	152		
DANDY Arterienklemmen	67		
Darm- und			
Gewebefaßzangen	128-129		
Darmklemmen	130-131		
DEAVER Chirurgische Scheren	12		
DEAVER Wundhaken	103-105		
DEBAKEY			
atraumatische Pinzetten	30-31		
DESJARDINS Gallensteinlöffel	136		
DESMARRES Lidhalter	106		
Diagnostik Hämmer	126		
DIXON PEAN Arterienklemmen	67		
DOUGLAS BOZEMANN			
Tamponzange	89		
DOYEN Myomheber	143		
Drahtscheren	21		
Dura- und Hauthäkchen	93		
<b>E</b>			
EDNA (LORNA) Tuchklemmen	80		
Ersatzlampen für Laryngoskop-Spatel	167-169		
ESMARCH Verbandschere	118		
<b>F</b>			
Fadenscheren	20		
FARABEUW-BABY Wundhaken	96		
FARABEUW Wundhaken	96		
FEILCHENFELD Splitterpinzetten	36		
Feine Pinzetten	26-28		
Feine Scheren	6-9		
Fingerring Säge	123		
FOERSTER (BALLENGER)			
Schwammzangen	86		
FOERSTER Schwammzangen	86, 87		
FOX feine Scheren	9		
FRAZIER (FERGUSON)			
Sauginstrument	40		
FRAZIER Sauginstrumente	40		
FRIEDMANN Hohlmeißelzange	113		
<b>G</b>			
Gallensteinlöffel	136		
Geburtszangen	154-156		
GEISSENDOERFER OVERHOLT			
Präparier- und Ligaturklemmen	75		
GELPI-BABY Wundspreizer	109		
GEMINI Präparier- und			
Ligaturklemmen	77		
GERALD anatomische Pinzette	32		
GERALD chirurgische Pinzette	32		
Gewebefaßklemmen	79		
Gewebefaßpinzetten	33		
Gewebefaßzangen	128-129		
GILLIES Dura- und Hauthäkchen	93		
GILLIES feine Pinzette	27		
Gipsabreißzangen	119		
Gipsinstrumente	119-120		
Gippscheren	120		
Gipsspreizer	119		
GRAVES Scheidenspekula	140		
GREEN-ARMYTAGE			
Uterusklemmzange	152		

## Alphabetischer Index

GROSS Kornzangen	84, 85	KELLY RANKIN Arterienklemmen	60	Löffel scharf	112
GRUENWALD Bajonettpinzetten	34 H	KELLY Sphinkteroskope	133	LONDON-COLLEGE Zahnpinzetten	35
<b>H</b>		KEVORKIAN TISCHLER Biopsiezange Gyn.	148	LUCAE Bajonettpinzette	34
Hakenzangen Gyn.	142	KEVORKIAN-YOUNGE Biopsiezange Gyn.	150	LUER Hohlmeißelzange	113
HALLE HARTMANN Nasenspekula	158	KIELLAND Geburtszange	156	LUER STILLE Hohlmeißelzangen	115
Halogenlampe für Laryngoskop- griffe	165	Klemmen	56-82	<b>M</b>	
HALSEY Nadelhalter	46, 47	Klemmen Arterien	56-72, 78-79	MAGILL Kathetereinführzangen	126
HALSTED (ADSON) Arterienklemmen	70	Klemmen Gewebefaß	79	MAIER Kornzangen	84, 85
HALSTED MICRO Arterienklemmen	56	Klemmen Ligatur	73-77	MATHIEU Nadelhalter	52
HALSTED-MOSQUITO Arterienklemmen	58	Klemmen Penis	138	MAYO-HEGAR Nadelhalter	48
Hämmer Diagnostik	126	Klemmen Präparier	73-77	MAYO-LEXER Operations- und Präparierscheren	15
Hämorrhoidenfaßzange	133	Klemmen Schlauch	81-82	MAYO Operations- und Präparierscheren	13
HARTMANN (BABY-MOSQUITO) Arterienklemmen	57	Klemmen Tonsillen	78	MAYO-STILLE Operations- und Präparierscheren	14
HARTMANN-HALLE Nasenspekula	158	Klemmen Tuch	80	MCGIVNEY Hämorrhoidenfaßzange	133
HARTMANN MICRO Arterienklemmen	56	Knochensplitterzangen	116	MCINDOE feine Pinzetten	27
HARTMANN Ohrzängchen	161	KOCHER Arterienklemmen	66	MCINTOSH Laryngoskope	162, 167
Hauthäkchen	93, 94	KOCHER Darmklemmen	130-131	MERIAM Zahnpinzetten	35
HEGAR MAYO Nadelhalter	48	KOCHER Wundhaken	102	METZENBAUM BABY Präparierscheren	16, 17
HEGAR OLSEN Nadelhalter	51	Kornzangen	84-85	METZENBAUM Präparierscheren	16, 17
HEISS Arterienklemmen	70	Küretten Uterus	144-145	METZENBAUM-slim Präparierscheren	19
HENNIG Gipsspreizer	119	<b>L</b>		MICHEL Wundklammer Instrumente	53
Hohlmeißelzangen	113-115	Ladegerät für Akkumulatoren (Laryn- gосkope)	171	MICRO-ADSON feine Pinzetten	26
HOSPITAL PRESBYTERIAN Schlauchklemmen	82	Ladegeräte für Laryngoskop- griffe	166, 170	MICRO-HALSTED Arterienklemmen	56
HUDSON (EWALD) feine Pinzetten	26	LAHEY Präparier- und Ligaturklemme	74	MICRO-HARTMANN Arterienklemmen	56
HUNTER Splitterpinzetten	36	LANGENBECK PARKER (US-ARMY) Wundhaken	98	MICRO-IRIS Scheren	7
<b>I</b>		LANGENBECK Wundhaken	102	MILLER Laryngoskope	164, 169
IRIS MICRO Scheren	7	Laryngoskope	162-171	MILLER SENN Wundhaken	92
Iris Scheren	7	Laryngoskope mit Fiberglas- lichtleitung	162-166	MIXTER-BABY Präparier- und Ligaturklemmen	76
IRIS STANDARD Scheren	7	Laryngoskopgriff mit Leuchtdiode	166	MIXTER chirurgische Scheren	12
<b>J</b>		Laryngoskopgriff mit Trafo- Anschluß	170	MIXTER Präparier- und Ligaturklemmen	77
JANSEN ZAUFAL Hohlmeißelzange	114	Laryngoskopgriffe	165-166, 170	MOD. USA Gipsspreizer	119
JOSEPH Wund- und Hauthäkchen	94	Laryngoskop-Sätze	162-164, 167-169	MOD. USA Nabelschnurschere	153
<b>K</b>		Laryngoskop-Spatel mit Fiberglaslicht- leitung	162-164	MOD. WIEN Nasenspekula	159
Kathetereinführzangen	126	Laryngoskop-Spatel mit Glühlampe	167-169	MORGAN TISCHLER Biopsiezange Gyn.	150
KELLY Arterienklemmen	60	LERICHE Arterienklemmen	59	MOSQUITO HALSTED Arterienklemmen	58
KELLY feine Scheren	9	LEXER MAYO Operations- und Präparierscheren	15	Myomheber	143
		Lidhalter	106		
		Ligaturklemmen	73-77		
		LISTER Kornzangen	84		
		LISTER Verbandscheren	118		
		LISTON Knochensplitterzangen	116		
		LITTAUER Fadenschere	20		

## Alphabetischer Index

<b>N</b>		
Nabelschnurscheren	153	
Nadelhalter	44-52	
Nadelhalter TC		
Erläuterungen	44	
NAEGELE Geburtszange	155	
Nagelspaltzange	123	
Nagelzangen	122-123	
Nasenspekula	158-160	
NEIVERT Nadelhalter	45	
NELSON (METZENBAUM)		
Präparierscheren	18	
Nierensteinzangen	137	
Nummerischer Index	163-168	
<b>O</b>		
OCHSNER ROCHESTER		
Arterienklemmen	68-69	
Ohrzängchen	161	
OLSEN-HEGAR Nadelhalter	51	
Operations- und		
Präparierscheren	13-15	
OVERHOLT BABY		
Präparier- und Ligaturklemmen	74	
OVERHOLT-GEISSENDOERFER		
Präparier- und Ligaturklemmen	75	
OVERHOLT		
Präparier- und Ligaturklemmen	73	
<b>P</b>		
PARKER-LANGENBECK (US-ARMY)		
Wundhaken	98	
PARKER Wundhaken	97	
PEAN Arterienklemmen	59, 66	
PEAN-BABY Arterienklemmen	57	
PEAN-DIXON Arterienklemmen	67	
PEAN ROCHESTER		
Arterienklemmen	64-65	
PEDERSON Scheidenspekula	140	
PEET Splitterzange	37	
Penisklemmen	138	
PENNINGTON		
Arterien- und		
Gewebefaßklemmen	79	
Pinzetten	24-35	
Pinzetten anatomisch	24, 29, 32	
Pinzetten atraumatisch	30-31	
Pinzetten Bajonett	34	
Pinzetten chirurgisch	25, 29, 32	
Pinzetten fein	26-28	
Pinzetten Gewebefaß	33	
Pinzetten Splitter	36	
Pinzetten Zahn	35	
PIPER Geburtszange	156	
POOLE Sauginstrumente	41	
POTTS-SMITH		
anatomische Pinzetten	29	
POTTS-SMITH		
chirurgische Pinzetten	29	
POZZI Hakenzange Gyn.	142	
Präparier- und		
Ligaturklemmen	73-77	
Präparierscheren	13-19	
PRATT Rektalspekulum	132	
PRESBYTERIAN-HOSPITAL		
Schlauchklemmen	82	
<b>R</b>		
RALK Splitterzange	37	
RANDALL Nierensteinzangen	137	
RANKIN CRILE Arterienklemmen	61	
RANKIN-KELLY Arterienklemmen	60	
RECAMIER Uterusküretten	144-145	
Rektalspekula	132	
ROBERTS Arterienklemmen	71	
ROCHESTER-OCHSNER		
Arterienklemmen	68-69	
ROCHESTER-PEAN		
Arterienklemmen	64-65	
ROUX Wundhaken	98	
RUSKIN Hohlmeißelzange	114	
RUSS. MOD. Gewebefaßpinzetten	33	
<b>S</b>		
Sauginstrumente	40-41	
SAWTELL SCHNIDT		
Arterien- und Tonsillenklemmen	78	
SCHAEDEL Tuchklemme	80	
Scheidenspekula	140-141	
Scheren	6-21	
Scheren chirurgisch	10-12	
Scheren Damm	152	
Scheren Draht	21	
Scheren Faden	20	
Scheren fein	6-9	
Scheren Gips	120	
Scheren Iris	7	
Scheren Nabelschnur	153	
Scheren Operations-		
und Präparier	13-15	
Scheren Präparier	13-19	
Scheren Verband	118	
Schlauchklemmen	81-82	
SCHNIDT (BOETTCHER)		
Arterien- und Tonsillenklemmen	78	
SCHNIDT (SAWTELL)		
Arterien- und Tonsillenklemmen	78	
SCHROEDER Hakenzange Gyn.	142	
SCHUBERT		
Biopsiezangen Gyn.	146	
SCHUMACHER-VAN DOREN		
Biopsiezangen Gyn.	147	
Schwammzangen	86-87	
SEMKEN feine Pinzetten	28	
SENN-MILLER Wundhaken	92	
SIMPSON-BRAUN		
Geburtszange	155	
SIMPSON Geburtszangen	154, 155	
SIMS Rektalspekulum	132	
SIMS Scheidenspekula	141	
SIMS Uterussonden	141	
Skalpelle	2-3	
Skalpellgriffe	3	
Skalpellklingen	2	
SMITH POTTS anatomische und		
chirurgische Pinzetten	29	
SPENCER		
Fadenscheren	20	
SPENCER-WELLS		
Arterienklemmen	62-63	
Sphinkteroskope	133	
Splitterpinzetten	36	
Splitterzangen	37	
STADLER BRAUN Dammschere	152	
STEVENS feine Scheren	8	
STIEGLITZ (WILLIAMS)		
Splitterzangen	37	
STILLE Gipsscheren	120	
STILLE-LUER Hohlmeißelzangen	115	
STILLE MAYO Operations- und		
Präparierscheren	14	
STOCKMANN Penisklemme	138	
STRAUSS Penisklemme	138	
<b>T</b>		
Tamponzangen	88-89	
TAYLOR Diagnostik Hammer	126	
TC Nadelhalter	45-48, 50-52	
TC Nadelhalter Erläuterungen	44	
TISCHLER BABY		
Biopsiezange Gyn.	149	
TISCHLER Biopsiezange Gyn.	149	
TISCHLER-KEVORKIAN		
Biopsiezange Gyn.	148	
TISCHLER-MORGAN		
Biopsiezange Gyn.	150	
Tonsillenklemmen	78	
Trachealhaken	95	
Transformator für		
Laryngoskopgriff	170	

<b>TROELTSCH (WILDE)</b>	
Bajonettpinzette	34
TISCHLER Biopsiezange Gyn.	149
Tuchklemmen	80
TUFFIER Arterien- und Gewebefaßklemme	79

**U**

UNIVERSAL Drahtschere	21
Uterusklemmzange	152
Uterusküretten	144-145
Uterussonden	141

**V**

<b>VAN DOREN</b>	
Biopsiezange Gyn.	147
<b>VAN DOREN SCHUHMACHER</b>	
Biopsiezangen Gyn.	147
Verbandscheren	118
VOLKMANN scharfe Löffel	112
VOLKMANN Wundhaken	99-101 W

**W**

WAGNER feine Scheren	6
WALDMANN Dammschere	152
WEBSTER Nadelhalter	45
WEITLANER Wundspreizer	108
<b>WELLS SPENCER</b>	
Arterienklemmen	62-63
<b>WISCONSIN WIS-FOREGGER</b>	
Laryngoskope	163, 168
<b>WIS-FOREGGER (WISCONSIN)</b>	
Laryngoskope	163, 168
<b>WOLFF-BOEHLER</b>	
Gipsabreißzangen	119
<b>WOOD CRILE BABY</b>	
Nadelhalter	49, 50
WOOD CRILE Nadelhalter	49, 50
WRIGHT (DERF) Nadelhalter	46
WRIGLEY Geburtszange	154
Wundhaken	92-106 Wundklammer
Instrumente	53
Wundspreizer	108-109

**Y**

YANKAUER Sauginstrument	41
<b>YOUNGE KEVORKIAN</b>	
Biopsiezange Gyn.	150

**Z**

Zahnpinzetten	35
Zängchen Ohr	161
Zange Uterus	152
Zangen Biopsie Gyn.	146-150
Zangen Darmfaß	128-129
Zangen Geburt	154-156
Zangen Gewebefaß	128-129
Zangen Gipsabreiß	119
Zangen Haken	142
Zangen Hohlmeißel	113-115
Zangen Kathetereinführ	126
Zangen Knochensplitter	116
Zangen Korn	84-85
Zangen Nagel	122-123
Zangen Nierenstein	137
Zangen Schwamm	86-87
Zangen Splitter	37
Zangen Tampon	88-89
<b>ZAUFAL-JANSEN</b>	
Hohlmeißelzange	114

## Alphabetical Index

<b>A</b>		Batteries for laryngoscope handles	171	CUSCO Vaginal specula	140
Abdominal Retractors	110	BAUMGARTNER Needle holder	47	CUSHING Dressing forceps	32
Accumulator for laryngoscope handles	171	Bayonet forceps	34	CUSHING Tissue forceps	32
ADSON-BABY		<b>BECKMANN</b>		<b>D</b>	
Dissecting and ligature forceps	76	Self-retaining retractors	109	DANDY Hemostatic forceps	67
ADSON-BROWN Delicate forceps	27	BEEBEE Wire cutting scissors	21	DEAVER Operating scissors	12
ADSON Delicate forceps	26	BENGOLEA Hemostatic forceps	72	DEAVER Retractors	103-105
ADSON HALSTED		BERGMANN Bandage scissors	118	DEBAKEY Atraumatic forceps	30-31
Hemostatic forceps	70	BEYER Bone rongeurs	114	Delicate forceps	26-28
ADSON MICRO Delicate forceps	26	Biopsy forceps Gyn.	146-150	Delicate scissors	6-9
ALLIS-BABY		BIRKETT Hemostatic forceps	71	Dental pliers	35
Intestinal and tissue forceps	128	BLUMENTHAL Bone rongeurs	113	DESJARDINS Gall stone scoops	136
ALLIS Intestinal and tissue forceps	128	<b>BOEHLER WOLFF</b>		DESMARRES Lid retractor	106
Alphabetical Index	170-189	Plaster cast breakers	119	Dissecting and ligature forceps	73-77
ARMYTAGE GREEN		BOETTCHER SCHNIDT		Dissecting scissors	13-19
Uterine clamp forceps	152	Hemostatic and tonsil forceps	78	DIXON PEAN Hemostatic forceps	67
Aspirating instruments	40-41	Bone curettes	112	<b>DOUGLAS BOZEMANN</b>	
Atraumatic forceps	30-31	Bone cutting forceps	116	Dressing forceps	89
<b>B</b>		Bone rongeurs	113-115	DOYEN mMyoma screw	143
BABCOCK		<b>BOZEMANN-DOUGLAS</b>		Dressing forceps	24, 29, 32, 84-85, 88-89
Intestinal and tissue forceps	129	Dressing forceps	89	Dura and skin hooks	93
BABY ADSON		BOZEMANN Dressing forceps	88	<b>E</b>	
Dissecting and ligature forceps	76	<b>BRAUN SIMPSON</b>		Ear forceps	161
BABY ALLIS		Obstetrical forceps	155	EDNA (LORNA) Towel clamps	80
Intestinal and tissue forceps	128	<b>BRAUN-STADLER</b>		Episiotomy scissors	152
BABY BALFOUR		Episiotomy scissors	152	ESMARCH Plaster shears	118
Abdominal retractors	110	BROWN ADSON Delicate forceps	27	<b>F</b>	
BABY CRILE-WOOD		BRUNS Bandage scissors	118	FARABEUF-BABY Retractors	96
Needle holder	49, 50	BUCK Percussion hammer	126	FARABEUF Retractors	96
BABY FARABEUF Retracto	96	BURKE Biopsy forceps Gyn.	148	FEILCHENFELD Splinter forceps	36
BABY GELPI		BUSCH Umbilical scissors	153	Finger ring cutter	123
Self-retaining retractor	109	<b>C</b>		FOERSTER (BALLENGER)	
BABY-METZENBAUM		Catheter introducing forceps	126	Sponge forceps	86
Dissecting scissors	16, 17	CHAPUT Hemostatic and tissue grasping forceps	79	FOERSTER Sponge forceps	86, 87
BABY MIXTER		Charging device for accumulators (laryngoscopes)	171	Forceps	24-35, 56-82
Dissecting and ligature forceps	76	Charging devices for laryngoscope handles	166, 170	Forceps atraumatic	30-31
BABY-MOSQUITO HARTMANN		Clamps meatus	138	Forceps bayonet	34
Hemostatic forceps	57	Clamps towel	80	Forceps biopsy Gyn.	146-150
BABY-OVERHOLT		Clamps tubing	81-82	Forceps bone cutting	116
Dissecting and ligature forceps	74	Clip applying instruments	53	Forceps catheter introducing	126
BABY PEAN Hemostatic forceps	57	COLLEGE LONDON Dental pliers	35	Forceps delicate	26-28
BABY-TISCHLER		COLLIN Hemostatic and tissue grasping forceps	79	Forceps dissecting	73-77
Biopsy forceps Gyn.	149	COTTLE Nasal specula	160	Forceps dressing	24, 29, 32
BACKHAUS towel Clamps	80	CRILE Hemostatic forceps	61	Forceps ear	161
BALFOUR-BABY		CRILE-RANKIN Hemostatic forceps	61	Forceps hemostatic	56-72, 78-79
Abdominal retractors	110	CRILE-WOOD BABY		Forceps intestinal	128-129
BALFOUR Abdominal retractors	110	Needle holder	49, 50	Forceps kidney stone	137
BALLENGER FOERSTER		CRILE WOOD Needle holder	49, 50	Forceps ligature	73-77
Sponge forceps	86	Curette uterine	144-145		
Bandage scissors	118				



## Alphabetical Index

Forceps obstetrical	154-156	HEGAR MAYO Needle holders	48	Laryngoscopes	162-171
Forceps splinter	36, 37	HEGAR OLSEN Needle holders	51	Laryngoscopes with fibre optic light guide	162-166
Forceps tissue	25, 29, 32	HEISS Hemostatic forceps	70	LERICHE Hemostatic forceps	59
Forceps tissue grasping	33, 79, 128-129	Hemostatic forceps	56-72, 78-79	LEXER MAYO Operating and dissecting scissors	15
Forceps tonsil	78	HENNIG Plaster spreader	119	Lid retractors	106
Forceps uterine	152	HOSPITAL PRESBYTERIAN Tubing clamps	82	Ligature forceps	73-77
FOX Delicate scissors	9	HUDSON (EWALD) Delicate forceps	26	LISTER Bandage scissors	118
FRAZIER Aspirating instruments	40	HUNTER Splinter forceps	36	LISTER Dressing forceps	84
FRAZIER (FERGUSSON) Aspirating instrument	40	<b>I</b>		LISTON Bone cutting forceps	116
FRIEDMANN Bone rongeurs	113	Intestinal and tissue forceps	128-129	LITTAUER Stitch scissors	20
<b>G</b>		Intestinal forceps	130-131	LONDON-COLLEGE Dental pliers	35
Gall stone scoops	136	IRIS MICRO Scissors	7	LUCAE Bayonet forceps	34
GEISSENDOERFER OVERHOLT Dissecting and ligature forceps	75	Iris scissors	7	LUER Bone rongeurs	113
GELPI-BABY Self-retaining retractors	109	IRIS STANDARD Scissors	7	LUER STILLE Bone rongeurs	115
GEMINI Dissecting and ligature forceps	77	<b>J</b>		<b>M</b>	
GERALD Dressing forceps	32	JANSEN ZAUFAL Bone rongeurs	114	MAGILL Catheter introducing forceps	126
GERALD Tissue forceps	32	JOSEPH Retractors and skin hooks	94	MAIER Dressing forceps	84, 85
GILLIES Delicate forceps	27	<b>K</b>		MATHIEU Needle holder	52
GILLIES Dura and skin hooks	93	KELLY Hemostatic forceps	60	MAYO-HEGAR Needle holder	48
GRAVES Vaginal specula	140	KELLY Delicate scissors	9	MAYO-LEXER Operating and dissecting scissors	15
GREEN-ARMYTAGE Uterine clamp forceps	152	KELLY RANKIN Hemostatic forceps	60	MAYO Operating and dissecting scissors	13
GROSS Dressing forceps	84, 85	KELLY Sphincteroscopes	133	MAYO-STILLE Operating and dissecting scissors	14
GRUENWALD Bayonet forceps	34	KEVORKIAN TISCHLER Biopsy forceps Gyn.	148	MCGIVNEY Haemorrhoidal grasping forceps	133
<b>H</b>		KEVORKIAN-YOUNGE Biopsy forceps Gyn.	150	MCINDOE Delicate forceps	27
Haemorrhoidal grasping forceps	133	Kidney stone forceps	137	MCINTOSH Laryngoscopes	162, 167
HALLE HARTMANN Nasal specula	158	KIELLAND Obstetrical forceps	156	Meatus Clamps	138
Halogen lamp for laryngoscope handles	165	KOCHER Hemostatic forceps	66	MERIAM Dental pliers	35
HALSEY Needle holder	46, 47	KOCHER Intestinal forceps	130-131	METZENBAUM BABY Dissecting scissors	16,17
HALSTED (ADSON) Hemostatic forceps	70	KOCHER Retractors	102	METZENBAUM Dissecting scissors	16, 17
HALSTED MICRO Hemostatic forceps	56	<b>L</b>		METZENBAUM-slim Dissecting scissors	19
HALSTED MOSQUITO Hemostatic forceps	58	LAHEY Dissecting and ligature forceps	74	MICHEL Clip applying instruments	53
Hammers percussion	126	LANGENBECK PARKER (US-ARMY) Retractors	98	MICRO-ADSON Delicate forceps	26
HARTMANN (BABY-MOSQUITO) Hemostatic forceps	57	LANGENBECK Retractors	102	MICRO-HALSTED Hemostatic forceps	56
HARTMANN Ear forceps	161	Laryngoscope blades with fibre optic light guide	162-164	MICRO-HARTMANN Hemostatic forceps	56
HARTMANN-HALLE Nasal specula	158	Laryngoscope blades with integrated lamp	167-169	MICRO-IRIS Scissors	7
HARTMANN MICRO Hemostatic forceps	56	Laryngoscope handle with light-emitting diode	166	MILLER Laryngoscopes	164, 169
		Laryngoscope handle with Transformer connection	170	MILLER SENN Retractors	92
		Laryngoscope handles	165-166,170	MIXTER-BABY Dissecting and ligature forceps	76
		Laryngoscope sets	162-164, 167-169	MIXTER Dissecting and ligature forceps	77

## Alphabetical Index

MIXTER Operating scissors	12	Percussion hammers	126	Scissors delicate	6-9
MOD. USA Plaster spreader	119	PIPER Obstetrical forceps	156	Scissors dissecting	13-19
MOD. USA Umbilical scissors	153	Plaster cast breakers	119	Scissors episiotomy	152
MOD. VIENNA Nasal specula	159	Plaster instruments	119-120	Scissors Iris	7
MORGAN TISCHLER		Plaster shears	120	Scissors operating	10-12
Biopsy forceps Gyn.	150	Plaster spreader	119	Scissors operating	
MOSQUITO HALSTED		POOLE Aspirating instruments	41	and dissecting	13-15
Hemostatic forceps	58	POTTS-SMITH Dressing forceps	29	Scissors stitch	20
Myoma screws	143	POTTS-SMITH Tissue forceps	29	Scissors umbilical	153
<b>N</b>		POZZI Tenaculum forceps Gyn.	142	Scissors wire cutting	21
NAEGELE Obstetrical forceps	155	PRATT Rectal specula	132	Self-retaining retractors	108-109
Nail nippers	122-123	PRESBYTERIAN-HOSPITAL		SEMKEN Delicate forceps	28
Nail splitter	123	Tubing clamps	82	SENN-MILLER Retractors	92
Nasal specula	158-160	<b>R</b>		Shears plaster	120
Needle holders	44-52	RALK Splinter forceps	37	SIMPSON-BRAUN	
Needle holders TC		RANDALL Kidney stone forceps	137	Obstetrical forceps	155
information	44	RANKIN CRILE Hemostatic forceps	61	SIMPSON Obstetrical forceps	154, 155
NEIVERT Needle holder	45	RANKIN KELLY Hemostatic forceps	60	SIMS Rectal specula	132
NELSON (METZENBAUM)		RECAMIER Uterine curettes	144-145	SIMS Uterine probes	141
Dissecting scissors	18	Rectal specula	132	SIMS Vaginal specula	141
Nippers nail	122-123	Replacement lamps for laryngoscope		Skin hooks	93, 94
Numerical Index	163-168	blades	167-169	SMITH POTTS Dissecting forceps	29
<b>O</b>		Retractors	92-106	SMITH POTTS Dressing forceps	29
Obstetrical forceps	154-156	ROBERTS Hemostatic forceps	71	SPENCER Stitch scissors	20
OCHSNER ROCHESTER		ROCHESTER OCHSNER		SPENCER-WELLS	
Hemostatic forceps	68-69	Hemostatic forceps	68-69	Hemostatic forceps	62-63
OLSEN-HEGAR Needle holder	51	ROCHESTER-PEAN		Sphincteroscopes	133
Operating and		Hemostatic forceps	64-65	Splinter forceps	36, 37
dissecting scissors	13-15	Rongeurs bone	113-115	Sponge forceps	86-87
Operating scissors	10-12	ROUX Retractors	98	STADLER BRAUN	
OVERHOLT BABY		RUSKIN Bone rongeurs	114	Episiotomy scissors	152
Dissecting and ligature clamp	74	RUSS. MOD.		STEVENS Delicate scissors	8
OVERHOLT		Tissue grasping forceps	33	STIEGLITZ (WILLIAMS)	
Dissecting and ligature forceps	73	<b>S</b>		Splinter forceps	37
OVERHOLT-GEISSENDOERFER		SAWTELL SCHNIDT		STILLE-LUER Bone rongeurs	115
Dissecting and ligature forceps	75	Hemostatic and tonsil forceps	78	STILLE MAYO Operating and	
<b>P</b>		Scalpel blades	2	dissecting scissors	14
PARKER-LANGENBECK (US-ARMY)		Scalpel handles	3	STILLE Plaster shears	120
Retractors	98	Scalpels	2-3	Stitch scissors	20
PARKER Retractors	97	SCHAEDEL Towel clamp	80	STOCKMANN Meatus clamps	138
PEAN Hemostatic forceps	59, 66	SCHNIDT (BOETTCHER)		STRAUSS Meatus clamps	138
PEAN-BABY Hemostatic forceps	57	Hemostatic and tonsil forceps	78	<b>T</b>	
PEAN-DIXON Hemostatic forceps	67	SCHNIDT (SAWTELL)		TAYLOR Percussion hammer	126
PEAN ROCHESTER		Hemostatic and tonsil forceps	78	TC needle holders	45-48, 50-52
Hemostatic forceps	64-65	SCHROEDER		TC needle holders	
PEDERSON Vaginal specula	140	Tenaculum forceps Gyn.	142	information	44
PEET Splinter forceps	37	SCHUBERT Biopsy forceps Gyn.	146	Tenaculum forceps	142
PENNINGTON Hemostatic and		SCHUMACHER-VAN DOREN		TISCHLER BABY	
tissue grasping forceps	79	Biopsy forceps Gyn.	147	Biopsy forceps Gyn.	149
		Scissors	6-21	TISCHLER-KEVORKIAN	
		Scissors bandage	118	Biopsy forceps Gyn.	148
				TISCHLER-MORGAN	
				Biopsy forceps Gyn.	150

Tissue forceps	25, 29, 32	Uterine curettes	144-145	Wire cutting scissors	21
Tissue grasping forceps	33, 79, 128-129	Uterine probes	141	WISCONSIN WIS-FOREGGER Laryngoscopes	163, 168
Tonsil forceps	78	<b>V</b>		WIS-FOREGGER (WISCONSIN) Laryngoscopes	163, 168
Towel clamps	80	Vaginal specula	140-141	WOLFF-BOEHLER Plaster cast breakers	119
Tracheal retractors	95	VAN DOREN Biopsy forceps Gyn.	147	WOOD CRILE BABY Needle holder	49, 50
Transformer for laryngoskop handle	170	VAN DOREN SCHUMACHER Biopsy forceps Gyn.	147	WOOD CRILE Needle holder	49, 50
TROELTSCH (WILDE) Bayonet forceps	34	VOLKMANN Bone curettes	112	WRIGHT (DERF) Needle holder	46
TISCHLER Biopsy forceps Gyn.	149	VOLKMANN Retractors	99-101	WRIGLEY Obstetrical forceps	154
Tubing clamps	81-82	<b>W</b>			
TUFFIER Hemostatic and tissue grasping forceps	79	WAGNER Delicate scissors	6	<b>Y</b>	
<b>U</b>		WALDMANN Episiotomy scissors	152	YANKAUER Aspirating instrument	41
Umbilical scissors	153	WEBSTER Needle holder	45	YOUNGE KEVORKIAN Biopsy forceps Gyn.	150
UNIVERSAL Wire cutting scissors	21	WEITLANER Self-retaining retractors	108	<b>Z</b>	
Uterine clamp forceps	152	WELLS SPENCER Hemostatic forceps	62-63	ZAUFAL-JANSEN Bone rongeurs	114

## Índice alfabético

<b>A</b>		<b>B</b>		<b>D</b>	
Acumulador para mangos laringoscopios	171	BENGOLEA Pinzas hemostáticas	72	DANDY Pinzas hemostáticas	67
ADSON-BABY Pinzas para preparaciones y ligaduras	76	BERGMANN Tijera para vendajes	118	DEAVER Separadores	103-105
ADSON-BROWN Pinzas finas	27	BEYER Pinza-gubia	114	DEAVER Tijeras quirúrgicas	12
ADSON HALSTED Pinzas hemostáticas	70	BIRKETT Pinza hemostática	71	DEBAKEY Pinzas atraumáticas	30-31
ADSON MICRO Pinzas finas	26	Bisturí	2-3	DESJARDINS Cucharillas para cálculos biliares	136
ADSON Pinzas finas	26	BLUMENTHAL Pinzas-gubias	113	DESMARRES Separadores para párpados	106
ALLIS-BABY Pinza para coger intestino y tejidos	128	BOEHLER WOLFF Pinzas para yesos	119	DIXON PEAN Pinzas hemostáticas	67
ALLIS Pinzas para coger intestino y tejidos	128	BOETTCHER SCHNIDT Pinzas hemostáticas y tonsilares	78	DOUGLAS BOZEMANN Pinza para taponamiento	89
ARMYTAGE GREEN Pinza-clamp uterina	152	BOZEMANN-DOUGLAS Pinza para taponamiento	89	DOYEN Tirabuzones para fibroma	143
<b>B</b>		BOZEMANN Pinzas para taponamiento	88	<b>E</b>	
BABCOCK Pinzas para coger intestino y tejidos	129	BRAUN SIMPSON Fórceps obstétricos	155	EDNA (LORNA) Pinzas de campo	80
BABY ADSON Pinzas para preparaciones y ligaduras	76	BRAUN-STADLER Tijera perineal	152	Esfinteroscopios	133
BABY ALLIS Pinza para coger intestino y tejidos	128	BROWN ADSON Pinzas finas	27	ESMARCH Tijera para vendajes	118
BABY BALFOUR Separador abdominal	110	BRUNS Tijera para vendajes	118	Espátulas de laringoscopios con conductor de luz fría	162-164
BABY CRILE-WOOD Porta-agujas	49, 50	BUCK Martillo para diagnóstico	126	Espátulas de laringoscopios con lampara incandescente	167-169
BABY FARABEUF Separadores	96	BURKE Pinza para biopsia para ginecología	148	Espéculos nasales	158-160
BABY GELPI Separador	109	BUSCH Tijera para cordón umbilical	153	Espéculos rectales	132
BABY-METZENBAUM Tijeras para preparaciones	16, 17	<b>C</b>		Espéculos vaginales	140-141
BABY MIXTER Pinzas para preparaciones y ligaduras	76	Cargador per acumuladores (laringoscopios)	171	Explicaciones Porta-agujas con insertos de tungsteno	44
BABY-MOSQUITO HARTMANN Pinzas hemostáticas	57	Cargadores per mangos laringoscopios	166, 170	<b>F</b>	
BABY-OVERHOLT Pinza para preparaciones y ligaduras	74	Cizallas para yesos	120	FARABEUF-BABY Separadores	96
BABY PEAN Pinzas hemostáticas	57	COLLEGE LONDON Pinzas dentales	35	FARABEUF Separadores	96
BABY-TISCHLER Pinza para biopsia para ginecología	149	COLLIN Pinza hemostática y para coger tejido	79	FEILCHENFELD Pinzas para espina	36
BACKHAUS Pinzas de campo	80	COTTLE Espéculos nasales	160	FOERSTER (BALLENGER) Pinzas porta-esponjas	86
BALFOUR-BABY Separador abdominal	110	CRILE Pinzas hemostáticas	61	FOERSTER Pinzas porta-esponjas	86, 87
BALFOUR Separadores abdominales	110	CRILE-RANKIN Pinzas hemostáticas	61	Fórceps obstétricos	154-156
BALLENGER FOERSTER Pinzas porta-esponjas	86	CRILE-WOOD BABY Porta-agujas	49, 50	FOX Tijeras finas	9
BAUMGARTNER Porta-agujas	47	CRILE-WOOD Porta-agujas	49, 50	FRAZIER Cánulas aspiradoras	40
BECKMANN Separador autoestático	109	Cucharillas cortantes	112	FRAZIER (FERGUSSON) Cánula aspiradora	40
BEEBEE Tijeras para cortar hilo de acero	21	Cucharillas para cálculos biliares	136	FRIEDMANN Pinza-gubia	113
		Curetatas uterinas	144-145	<b>G</b>	
		CUSCO Espéculos vaginales	140	Ganchitos de piel	93, 94
		CUSHING Pinzas anatómicas	32	Ganchitos para dura-madre y piel	93
		CUSHING Pinzas quirúrgicas	32	Ganchos traqueales	95
		CHAPUT Pinza hemostática y para coger tejido	79	GEISSENDOERFER OVERHOLT Pinzas para preparacione y ligaduras	75
				GELPI-BABY Separador autoestático	109

## Índice alfabético

GEMINI Pinzas para preparaciones y ligaduras	77	<b>J</b>	MAIER Pinzas para curaciones	84, 85	
GERALD Pinza anatómica	32	JANSEN ZAUFAL Pinza-gubia	114	Mango de laringoscopio con conexión de transformador	170
GERALD Pinza quirúrgica	32	JOSEPH Separadores y ganchitos para piel	94	Mango de laringoscopio con diodo luminoso	166
GILLIES		Juegos laringoscopios	162-164, 167-169	Mangos de bisturí	3
Ganchitos para dura-madre y piel	93	<b>K</b>		Mangos de laringoscopios	165-166, 170
GILLIES Pinza fina	27	KELLY Esfinteroscopios	133	Martillos para diagnóstico	126
GRAVES Espéculos vaginales	140	KELLY Pinzas hemostáticas	60	MATHIEU Porta-agujas	52
GREEN-ARMYTAGE		KELLY RANKIN		MAYO-HEGAR Porta-agujas	48
Pinza-clamp uterina	152	Pinzas hemostáticas	60	MAYO-LEXER Tijeras para operaciones y preparaciones	15
GROSS Pinzas para curaciones	84, 85	KELLY Tijeras finas	9	MAYO-STILLE Tijeras para operaciones y preparaciones	14
GRUENWALD		KEVORKIAN TISCHLER Pinza para biopsia para ginecología	148	MAYO Tijeras para operaciones y preparaciones	13
Pinzas en forma bayoneta	34	KEVORKIAN-YOUNGE Pinza para biopsia para ginecología	150	MCGIVNEY Pinza hemorroidal	133
<b>H</b>		KIELLAND Fórceps obstétricos	156	MCINDOE Pinza fina	27
HALSEY Porta-agujas	46, 47	KOCHER Pinzas hemostáticas	66	MCINTOSH Laringoscopios	162, 167
HALSTED (ADSON)		KOCHER Pinzas intestinales	130-131	MERIAM Pinzas dentales	35
Pinzas hemostáticas	70	KOCHER Separadores	102	METZENBAUM BABY	
HALSTED MICRO		<b>L</b>		Tijeras para preparaciones	16, 17
Pinzas hemostáticas	56	LAHEY Pinza para preparaciones y ligaduras	74	METZENBAUM	
HALSTED MOSQUITO		Lampara halógena para mangos de laringoscopio	165	Tijeras para preparaciones	16, 17
Pinzas hemostáticas	58	Lamparas de repuesto para espátulas laringoscopios	167-169	METZENBAUM-slim	
HALLE HARTMANN		LANGENBECK PARKER (US-ARMY)		Tijeras para preparaciones	19
Espéculos nasales	158	Separadores	98	MICRO-ADSON Pinzas finas	26
HARTMANN (BABY-MOSQUITO)		LANGENBECK Separadores	102	MICRO-HALSTED	
Pinzas hemostáticas	57	Laringoscopios	162-171	Pinzas hemostáticas	56
HARTMANN-HALLE		Laringoscopios con conductor de luz fría	162-166	MICRO-HARTMANN	
Espéculos nasales	158	LERICHE Pinzas hemostáticas	59	Pinzas hemostáticas	56
HARTMANN MICRO		LEXER MAYO Tijeras para operaciones y preparaciones	15	MICRO-IRIS Tijeras para iridectomia	7
Pinzas hemostáticas	56	LISTER Pinzas para curaciones	84	MICHEL	
HARTMANN		LISTER Tijeras para vendajes	118	Instrumentos para poner agrafes	53
Pinza auricular	161	LISTON		MILLER Laringoscopios	164, 169
HEGAR MAYO Porta-agujas	48	Pinzas cortantes para huesos	116	MILLER SENN Separadores	92
HEGAR OLSEN Porta-agujas	51	LITTAUER Tijera de sutura	20	MIXTER-BABY Pinzas para preparaciones y ligaduras	76
HEISS Pinzas hemostáticas	70	LONDON-COLLEGE		MIXTER Pinzas para preparaciones y ligaduras	77
HENNIG Pinza para abrir vendajes	119	Pinzas dentales	35	MIXTER Tijeras quirúrgicas	12
Histerómetros	141	LUCAE Pinza en forma bayoneta	34	MOD. USA	
Hojas de bisturí	2	LUER Pinza-gubia	113	Pinza para abrir vendajes	119
HOSPITAL PRESBYTERIAN		LUER STILLE Pinzas-gubias	115	MOD. USA	
Pinzas cierra-tubos	82	<b>M</b>		Tijera para cordón umbilical	153
HUDSON (EWALD) Pinzas finas	26	MAGILL		MOD. WIEN Espéculos nasales	159
HUNTER Pinzas para espina	36	Pinzas para introducir catéteres	126	MORGAN TISCHLER Pinza para biopsia para ginecología	150
<b>I</b>				MOSQUITO HALSTED	
Índice alfabético	170-189			Pinzas hemostáticas	58
Índice numérico	163-168			<b>N</b>	
Instrumentos de aspiración	40-41			NAEGELE Fórceps obstétricos	155
Instrumentos para poner agrafes	53				
Instrumentos para vendajes	119-120				
IRIS MICRO Tijeras para iridectomia	7				
IRIS STANDARD					
Tijeras para iridectomia	7				

## Índice alfabético

NEIVERT Porta-agujas	45	Pinzas para coger tejido	33, 79	<b>S</b>	
NELSON (METZENBAUM)		Pinzas para coger tejidos	128-129	SAWTELL SCHNIDT	
Tijeras para preparaciones	18	Pinzas para cortar uñas	122-123	Pinzas hemostáticas y tonsilares	78
<b>O</b>		Pinzas para cuello		SCHAEDEL Pinza de campo	80
OCHSNER ROCHESTER		para ginecología	142	SCHNIDT (BOETTCHER)	
Pinzas hemostáticas	68-69	Pinzas para curaciones	84-85	Pinzas hemostáticas y tonsilares	78
OLSEN-HEGAR Porta-agujas	51	Pinzas para el pene	138	SCHNIDT (SAWTELL)	
OVERHOLT BABY Pinza para preparaciones y ligaduras	74	Pinzas para espina	36-37	Pinzas hemostáticas y tonsilares	78
OVERHOLT-GEISSENDOERFER		Pinzas para introducir catéteres	126	SCHROEDER Pinza para cuello para ginecología	142
Pinzas para preparaciones y ligaduras	75	Pinzas para ligaduras	73-77	SCHUBERT Pinzas para biopsia para ginecología	146
OVERHOLT Pinzas para preparaciones y ligaduras	73	Pinzas para preparaciones y ligaduras	73-77	SCHUMACHER-VAN DOREN Pinzas para biopsia para ginecología	147
<b>P</b>		Pinzas para taponamiento	88-89	SEMKEN Pinzas finas	28
PARKER-LANGENBECK (US-ARMY)		Pinzas para yesos	119	SENN-MILLER Separadores	92
Separadores	98	Pinzas porta-esponjas	86-87	Separadores	92-106
PARKER Separadores	97	Pinzas quirúrgicas	25, 29, 32	Separadores abdominales	110
PEAN Pinzas hemostáticas	59, 66	Pinzas tonsilares	78	Separadores autoestáticos	108-109
PEAN-BABY Pinzas hemostáticas	57	Pinzas-gubias	113-115	Separadores para párpados	106
PEAN-DIXON		PIPER Forceps obstétricos	156	Sierra para abrir anillos	123
Pinzas hemostáticas	67	POOLE Tubos aspiradores	41	SIMPSON-BRAUN	
PEAN ROCHESTER		Porta-agujas	44-52	Fórceps obstétricos	155
Pinzas hemostáticas	64-65	Porta-agujas con insertos de tungsteno	45-48, 50-52	SIMPSON	
PEDERSON Espéculos vaginales	140	POTTS-SMITH		Fórceps obstétricos	154, 155
PEET Pinza para espina	37	Pinzas anatómicas	29	SIMS Espéculo rectal	132
PENNINGTON Pinzas hemostáticas y para coger tejido	79	POTTS-SMITH Pinzas quirúrgicas	29	SIMS Espéculos vaginales	141
Pilas para mangos laringoscopios	171	POZZI Pinza para cuello para ginecología	142	SIMS Histerómetros	141
Pinza auricular	161	PRATT Espéculo rectal	132	SMITH POTTS Pinzas anatómicas	29
Pinza corta-uñas	123	PRESBYTERIAN-HOSPITAL		SMITH POTTS Pinzas quirúrgicas	29
Pinza hemorroidal	133	Pinzas cierra-tubos	82	SPENCER Tijeras de sutura	20
Pinza-clamp uterina	152	<b>R</b>		SPENCER-WELLS	
Pinzas	24-35, 56-82	RALK Pinza para espina	37	Pinzas hemostáticas	62-63
Pinzas anatómicas	24, 29, 32	RANDALL		STADLER BRAUN Tijera perineal	152
Pinzas atraumáticas	30-31	Pinzas para cálculos renales	137	STEVENS Tijeras finas	8
Pinzas cierra-tubos	81-82	RANKIN CRILE		STIEGLITZ (WILLIAMS)	
Pinzas cortantes para huesos	116	Pinzas hemostáticas	61	Pinzas para espina	37
Pinzas de campo	80	RANKIN-KELLY		STILLE Cizallas para yesos	120
Pinzas dentales	35	Pinzas hemostáticas	60	STILLE-LUER Pinzas-gubias	115
Pinzas en forma bayoneta	34	RECAMIER Curetas uterinas	144-145	STILLE MAYO Tijeras para operaciones y preparaciones	14
Pinzas finas	26-28	ROBERTS Pinzas hemostáticas	71	STOCKMANN Pinza para el pene	138
Pinzas hemostáticas	56-72, 78-79	ROCHESTER-OCHSNER		STRAUSS Pinza para el pene	138
Pinzas intestinales	130-131	Pinzas hemostáticas	68-69	<b>T</b>	
Pinzas para abrir vendajes	119	ROCHESTER-PEAN		TAYLOR Martillo para diagnóstico	126
Pinzas para biopsia para ginecología	146-150	Pinzas hemostáticas	64-65	Tijeras	6-21
Pinzas para cálculos renales	137	ROUX Separadores	98	Tijeras de sutura	20
Pinzas para coger intestino	128-129	RUSKIN Pinza-gubia	114	Tijeras finas	6-9
Pinzas para coger intestino y tejidos	128-129	RUSS. MOD.		Tijeras para cordón umbilical	153
		Pinzas para coger tejido	33	Tijeras para cortar hilo de acero	21
				Tijeras para iridectomía	7

## Índice alfabético

Tijeras para operaciones y preparaciones	13-15	<b>U</b>		WELLS SPENCER	
Tijeras para preparaciones	13-19	UNIVERSAL		Pinzas hemostáticas	62-63
Tijeras para vendajes	118	Tijera para cortar hilo de acero	21	WISCONSIN WIS-FOREGGER	
Tijeras perineales	152	<b>V</b>		Laringoscopios	163, 168
Tijeras quirúrgicas	10-12	VAN DOREN Pinza para biopsia para ginecología	147	WIS-FOREGGER (WISCONSIN)	
Tirabuzones para fibroma	143	VAN DOREN SCHUMACHER		Laringoscopios	163, 168
TISCHLER BABY Pinza para biopsia para ginecología	149	Pinzas para biopsia para ginecología	147	WOLFF-BOEHLER	
TISCHLER-KEVORKIAN Pinza para biopsia para ginecología	148	VOLKMANN Cucharillas cortantes	112	Pinzas para yesos	119
TISCHLER-MORGAN Pinza para biopsia para ginecología	150	VOLKMANN Separadores	99-101	WOOD CRILE BABY	
TISCHLER Pinza para biopsia para ginecología	149	<b>W</b>		Porta-agujas	49, 50
Transformador para mango laringoscopio	170	WAGNER Tijeras finas	6	WOOD CRILE	
TROELTSCH (WILDE)		WALDMANN Tijera perineal	152	Porta-agujas	49, 50
Pinza en forma bayoneta	34	WEBSTER Porta-agujas	45	WRIGHT (DERF) Porta-agujas	46
TUFFIER Pinza hemostática y para coger tejido	79	WEITLANER		WRIGLEY Fórceps obstétricos	154
		Separadores autoestáticos	108	<b>Y</b>	
				YANKAUER Tubos aspiradores	41
				YOUNGE KEVORKIAN Pinza para biopsia para ginecología	150
				<b>Z</b>	
				ZAUFAL-JANSEN Pinza-gubia	114

## Index alphabétique

<b>A</b>		
Accumulateur pour des manches de laryngoscopes		171
ADSON-BABY Pincés à préparations et à ligatures		76
ADSON-BROWN Pincés fines		27
ADSON HALSTED Pincés hémostatiques		70
ADSON MICRO Pincés fines		26
ADSON Pincés fines		26
ALLIS Pincés pour saisir l'intestin et les tissus		128
ALLIS-BABY Pince pour saisir l'intestin et les tissus		128
ARMYTAGE GREEN Pince-clamp utérine		152
<b>B</b>		
BABCOCK Pincés pour saisir l'intestin et les tissus		129
BABY ADSON Pincés à préparations et à ligatures		76
BABY ALLIS Pince pour saisir l'intestin et les tissus		128
BABY BALFOUR Ecarteur abdominal		110
BABY CRILE-WOOD Porte-aiguilles		49, 50
BABY FARABEUF Ecarteurs		96
BABY GELPI Ecarteur autostatique		109
BABY-METZENBAUM Ciseaux à préparations		16, 17
BABY MIXTER Pincés à préparations et à ligatures		76
BABY-MOSQUITO HARTMANN Pincés hémostatiques		57
BABY-OVERHOLT Pince à préparations et à ligatures		74
BABY PEAN Pincés hémostatiques		57
BABY-TISCHLER Pince à biopsie (gynécologie)		149
BACKHAUS Pincés à champs		80
BALFOUR Ecarteurs abdominaux		110
BALFOUR-BABY Ecarteur abdominal		110
BALLENGER FOERSTER Pincés à pansements		86
BAUMGARTNER Porte-aiguilles		47
BECKMANN Ecarteur autostatique		109
BEEBEE Ciseaux coupe-fil		21
BENGOLEA Pincés hémostatiques		72
BERGMANN Ciseaux à pansements		118
BEYER Pince-gouge		114
BIRKETT Pince hémostatique		71
Bistouris		2-3
BOEHLER WOLFF Pincés pour arracher les plâtres		119
BOETTCHER SCHNIDT Pincés hémostatiques et amygdaliennes		78
BOZEMANN-DOUGLAS Pince porte-tampons		89
BOZEMANN Pincés porte-tampons		88
BRAUN SIMPSON Forceps obstétricaux		155
BRAUN-STADLER Ciseaux périnéaux		152
BROWN ADSON Pincés fines		27
BRUNS Ciseaux à pansements		118
BUCK Maillet diagnostique		126
BURKE Pince à biopsie (gynécologie)		148
BUSCH Ciseaux pour le cordon ombilical		153
<b>C</b>		
CHAPUT Pince hémostatique pour saisir les tissus		79
Chargeur pour accumulateurs (laryngoscopes)		171
Chargeur pour manches laryngoscopiennes		166, 170
Cisailles à plâtre		120
Ciseaux		6-21
Ciseaux à iridectomie		7
Ciseaux à ligatures		20
Ciseaux à opérations et à préparations		13-15
Ciseaux à pansements		118
Ciseaux à préparations		13-19
Ciseaux chirurgicaux		10-12
Ciseaux coupe-fil		21
Ciseaux délicats		6-9
Ciseaux délicats		6-9
Ciseaux périnéaux		152
Ciseaux pour le cordon ombilical		153
COLLEGE LONDON Pincés dentales		35
COLLIN Pince hémostatique pour saisir les tissus		79
Compresseurs à ressort pour le pénis		138
COTTLE Spéculum nasaux		160
CRILE Pincés hémostatiques		61
CRILE-RANKIN Pincés hémostatiques		61
CRILE-WOOD BABY Porte-aiguilles		49, 50
CRILE-WOOD Porte-aiguilles		49, 50
Crochets dermatologiques		93, 94
Crochets dermatologiques et à dure-mère		93
Crochets trachéaux		95
Curettes pour calculs biliaires		136
Curettes tranchantes		112
Curettes utérines		144-145
CUSCO Spéculum vaginaux		140
CUSHING Pincés anatomiques		32
CUSHING Pincés chirurgicales		32
<b>D</b>		
DANDY Pincés hémostatiques		67
DEAVER Ciseaux chirurgicaux		12
DEAVER Ecarteurs		103-105
DEBAKEY Pincés atraumatiques		30-31
DESJARDINS Curettes pour calculs biliaires		136
DESMARRES Ecarteurs de paupières		106
Diagnostic - Maillets		126
DIXON PEAN Pincés hémostatiques		67
DOUGLAS BOZEMANN Pince porte-tampons		89
DOYEN Tracteurs pour fibromes		143
<b>E</b>		
Ecarteur à plâtre		119
Ecarteurs		92-106
Ecarteurs abdominaux		110
Ecarteurs autostatiques		108-109
Ecarteurs de paupières		106
EDNA (LORNA) Pincés à champs		80
ESMARCH Ciseaux à pansements		118
<b>F</b>		
FARABEUF-BABY Ecarteur		96
FARABEUF Ecarteur		96
FEILCHENFELD Pincés à écharde		36
FOERSTER (BALLENGER) Pincés à pansements		86
FOERSTER Pincés à pansements		86, 87



## Index alphabétique

Forceps obstétricaux	154-156	<b>I</b>		LONDON-COLLEGE	
FOX Ciseaux délicats	9			Pincés dentales	35
FRAZIER (FERGUSSON)				LUCAE Pince forme baïonnette	34
Instrument à aspiration	40	Instruments à aspiration	40-41	LUER Pince-gouge	113
FRAZIER Instruments à aspiration	40	Instruments à plâtre	119-120	LUER STILLE Pincés-gouges	115
FRIEDMANN Pince-gouge	113	Instruments pour poser les			
<b>G</b>		agrafes	53		
GEISSENDOERFER OVERHOLT		IRIS MICRO Ciseaux	7	<b>M</b>	
Pincés à préparations		IRIS STANDARD Ciseaux	7	MAGILL Pincés pour	
et à ligatures	75			introduire les sondes	126
GELPI-BABY		<b>J</b>		MAIER Pincés à pansements	84, 85
Ecarteur autostatique	109	JANSEN ZAUFAL Pince-gouge	114	Maillets diagnostiques	126
GEMINI Pincés à préparations		Jeux de laryngoscopes	162-164, 167-169	Manche de laryngoscope avec con-	
et à ligatures	77	JOSEPH Crochets		nexion de transformateur	170
GERALD Pincés anatomiques	32	dermatologiques et à plaie	94	Manche de laryngoscope avec diode	
GERALD Pincés chirurgicales	32			électroluminescente	166
GILLIES Crochets dermatologiques		<b>K</b>		Manches de bistouri	3
et à dure-mère	93	KELLY Ciseaux délicats	9	Manches de laryngoscopes	165-166, 170
GILLIES Pincés fines	27	KELLY Pincés hémostatiques	60	MATHIEU Porte-aiguilles	52
GRAVES Spéculum vaginaux	140	KELLY RANKIN		MAYO Ciseaux à opérations	
GREEN-ARMYTAGE		Pincés hémostatiques	60	et à préparations	13
Pince-clamp utérine	152	KELLY Sphincteroscopes	133	MAYO-HEGAR	
GROSS Pincés à pansements	84, 85	KEVORKIAN TISCHLER		Porte-aiguilles	48
GRUENWALD		Pince à biopsie (gynécologie)	148	MAYO-LEXER Ciseaux à	
Pincés forme baïonnette	34	KEVORKIAN-YOUNGE		opérations et à préparations	15
		Pince à biopsie (gynécologie)	150	MAYO-STILLE Ciseaux à	
<b>H</b>		KIELLAND Forceps obstétricaux	156	opérations et à préparations	14
HALLE HARTMANN		KOCHER Ecarteurs	102	MCGIVNEY Pince pour	
Spéculum nasaux	158	KOCHER		saisir les hémorroïdes	133
HALSEY Porte-aiguilles	46, 47	Pincés hémostatiques	66	MCINDOE Pincés fines	27
HALSTED (ADSON)		KOCHER Pincés intestinales	130-131	MCINTOSH Laryngoscopes	162, 167
Pincés hémostatiques	70			MERIAM Pincés dentales	35
HALSTED MICRO		<b>L</b>		METZENBAUM BABY	
Pincés hémostatiques	56	LAHEY Pince à préparations		Ciseaux à préparations	16, 17
HALSTED-MOSQUITO		et à ligatures	74	METZENBAUM	
Pincés hémostatiques	58	Lames de bistouri	2	Ciseaux à préparations	16, 17
HARTMANN (BABY-MOSQUITO)		Lampe halogène pour manches de		Ciseaux à préparations	19
Pincés hémostatiques	57	laryngoscopes	165	MICHEL Instruments pour	
HARTMANN-HALLE		Lampes de rechange pour les spatules		poser les agrafes	53
Spéculum nasaux	158	des laryngoscopes	167-169	MICRO-ADSON Pincés fines	26
HARTMANN MICRO		LANGENBECK Ecarteurs	102	MICRO-HALSTED	
Pincés hémostatiques	56	LANGENBECK PARKER (US-ARMY)		Pincés hémostatiques	56
HARTMANN		Ecarteurs	98	MICRO-HARTMANN	
Pince auriculaire	161	Laryngoscopes	162-171	Pincés hémostatiques	56
HEGAR MAYO Porte-aiguilles	48	Laryngoscopes à conducteur de		MICRO-IRIS Ciseaux	7
HEGAR OLSEN Porte-aiguilles	51	lumière en fibres de verre	162-166	MILLER Laryngoscopes	164, 169
HEISS Pincés hémostatiques	70	LERICHE Pincés hémostatiques	59	MILLER SENN	92
HENNIG Ecarteur à plâtre	119	LEXTER MAYO Ciseaux à		MIXTER-BABY Pincés à	
HOSPITAL PRESBYTERIAN		opérations et à préparations	15	préparations et à ligatures	76
Pincés presse-tube	82	LISTER Ciseaux à pansements	118	MIXTER Ciseaux chirurgicaux	12
HUDSON (EWALD) Pincés fines	26	LISTER Pincés à pansements	84	MIXTER Pincés à préparations	
HUNTER Pincés à échardes	36	LISTON Pincés coupantes	116	et à ligatures	77
Hystéromètres	141	LITTAUER Ciseaux à ligatures	20	MOD. USA Ciseaux pour le	
				cordon ombilical	153

## Index alphabétique

MOD. USA Ecarteur à plâtre	119	Pincès à échardes	36-37	Rochester-Ochsner	
MOD. WIEN		Pincès à ligatures	73-77	Pincès hémostatiques	68-69
Spéculum nasaux	159	Pincès à pansements	84-87	ROCHESTER-PEAN	
MORGAN TISCHLER		Pincès à préparations	73-77	Pincès hémostatiques	64-65
Pince à biopsie (gynécologie)	150	Pincès à préparations et à ligatures	73-77	ROUX Ecarteurs	98
MOSQUITO HALSTED		Pincès amygdaliennes	78	RUSKIN Pince-gouge	114
Pincès hémostatiques	58	Pincès anatomiques	24, 29, 32	RUSS. MOD.	
<b>N</b>		Pincès atraumatiques	30-31	Pincès pour saisir les tissus	33
NAEGELE Forceps obstétricaux	155	Pincès chirurgicales	25, 29, 32	<b>S</b>	
NEIVERT Porte-aiguilles	45	Pincès coupantes	116	SAWTELL SCHNIDT Pincès	
NELSON (METZENBAUM)		Pincès dentales	35	hémostatiques et amygdaliennes	78
Ciseaux à préparations	18	Pincès fines	26-28	SCHAEDEL Pince à champs	80
<b>O</b>		Pincès forme baïonnette	34	SCHNIDT (BOETTCHER) Pincès	
OCHSNER ROCHESTER		Pincès hémostatiques	56-72, 78-79	hémostatiques et amygdaliennes	78
Pincès hémostatiques	68-69	Pincès intestinales	130-131	SCHNIDT (SAWTELL) Pincès	
OLSEN-HEGAR		Pincès porte-tampons	88-89	hémostatiques et amygdaliennes	78
Porte-aiguilles	51	Pincès pour arracher les plâtres	119	SCHROEDER	
OVERHOLT BABY Pince à préparations et à ligatures	74	Pincès pour calculs rénaux	137	Pince pour le col (gynécologie)	142
OVERHOLT-GEISSENDOERFER		Pincès pour couper les ongles	122-123	SCHUBERT	
Pincès à préparations et à ligatures	75	Pincès pour introduire les sondes	126	Pincès à biopsie (gynécologie)	146
OVERHOLT Pincès à préparations et à ligatures	73	Pincès pour le col (gynécologie)	142	SCHUMACHER-VAN DOREN	
<b>P</b>		Pincès pour saisir l'intestin	128-129	Pincès à biopsie (gynécologie)	147
PARKER Ecarteurs	97	Pincès pour saisir l'intestin et les tissus	128-129	Scie pour couper les bagues	123
PARKER-LANGENBECK (US-ARMY)		Pincès pour saisir les tissus	33, 79, 128-129	SEMKEN Pincès fines	28
Ecarteurs	98	Pincès presse-tube	81-82	SENN-MILLER Ecarteurs	92
PEAN Pincès hémostatiques	59, 66	Pincès-gouges	113-115	SIMPSON	
PEAN-BABY		PIPER Forceps obstétricaux	156	Forceps obstétricaux	154, 155
Pincès hémostatiques	57	POOLE Instruments à aspiration	41	SIMPSON-BRAUN	
PEAN-DIXON		Porte-aiguilles	44-52	Forceps obstétricaux	155
Pincès hémostatiques	67	Porte-aiguilles TC - Explications	44	SIMS Hystéromètres	141
PEAN ROCHESTER		POTTS-SMITH		SIMS Spéculum rectal	132
Pincès hémostatiques	64-65	Pincès anatomiques	29	SIMS Spéculum vaginaux	141
PEDERSON Spéculum vaginaux	140	POTTS-SMITH		SMITH POTTS	
PEET Pince à échardes	37	Pincès chirurgicales	29	Pincès anatomiques	29
PENNINGTON Pincès hémostatiques pour saisir les tissus	79	POZZI		SMITH POTTS	
Piles pour des manches de laryngoscopes	171	Pince pour le col (gynécologie)	142	Pincès chirurgicales	29
Pince auriculaire	161	PRATT Spéculum rectal	132	Spatules de laryngoscopes à conducteur de lumière en fibres de verre	162-164
Pince pour couper les ongles	123	PRESBYTERIAN-HOSPITAL		Spatules de laryngoscopes avec lampe	167-169
Pince pour saisir les hémorroïdes	133	Pincès presse-tube	82	Spéculum nasaux	158-160
Pince utérine	152	<b>R</b>		Spéculum rectaux	132
Pince-clamp utérine	152	RALK Pince à échardes	37	Spéculum vaginaux	140-141
Pincès	24-35, 56-82	RANDALL		SPENCER Ciseaux à ligatures	20
Pincès à biopsie (gynécologie)	146-150	Pincès pour calculs rénaux	137	SPENCER-WELLS	
Pincès à champs	80	RANKIN CRILE		Pincès hémostatiques	62-63
		Pincès hémostatiques	61	Sphincteroscopes	133
		RANKIN-KELLY		STADLER-BRAUN	
		Pincès hémostatiques	60	Ciseaux périméaux	152
		RECAMIER Curettes utérines	144-145	STEVENS Ciseaux délicats	8
		ROBERTS Pincès hémostatiques	71	STIEGLITZ (WILLIAMS)	
				Pincès à échardes	37
				STILLE Cisailles à plâtre	120

STILLE-LUER Pincés-gouges	115	Tracteurs pour fibromes	143	WALDMANN Ciseaux périnéaux	152
STILLE MAYO Ciseaux à opérations et à préparations	14	Transformateur pour manche de laryngoscop	170	WEBSTER Porte-aiguilles	45
STOCKMANN Compresseur à ressort pour le pénis	138	TROELTSCH (WILDE) Pincés forme baïonnette	34	WEITLANER Ecarteurs autostatiques	108
STRAUSS Compresseur à ressort pour le pénis	138	TUFFIER Pince hémostatique pour saisir les tissus	79	WELLS SPENCER Pincés hémostatiques	62-63
<b>T</b>		<b>U</b>		WISCONSIN WIS-FOREGGER Laryngoscopes	163, 168
Table de matières alphabétique	170-189	UNIVERSAL Ciseaux coupe-fil	21	WIS-FOREGGER (WISCONSIN) Laryngoscopes	163, 168
Table de matières numérique	163-168	<b>V</b>		WOLFF-BOEHLER Pincés pour arracher les plâtres	119
TAYLOR Maillet diagnostique	126	VAN DOREN Pince à biopsie (gynécologie)	147	WOOD CRILE BABY Porte-aiguilles	49, 50
TC Porte-aiguilles	45-48, 50-52	VAN DOREN SCHUMACHER Pincés à biopsie (gynécologie)	147	WOOD CRILE Porte-aiguilles	49, 50
TC Porte-aiguilles Explications	44	VOLKMANN Curettes tranchantes	112	WRIGHT (DERF) Porte-aiguilles	46
TISCHLER BABY Pince à biopsie (gynécologie)	149	VOLKMANN Ecarteurs	99-101	WRIGLEY Forceps obstétricaux	154
TISCHLER-KEVORKIAN Pince à biopsie (gynécologie)	148	<b>W</b>		<b>Y</b>	
TISCHLER-MORGAN Pince à biopsie (gynécologie)	150	WAGNER Ciseaux délicats	6	YANKAUER Instrument à aspiration	41
TISCHLER Pince à biopsie (gynécologie)	149			YOUNGE KEVORKIAN Pince à biopsie (gynécologie)	150
				<b>Z</b>	
				ZAUFAL-JANSEN Pince-gouge	114

## Indice alfabetico

<b>A</b>					
Accumulatore per manici laringoscopi	171	BERGMANN		Divaricatore autostatico	108-109
ADSON-BABY Pinze per preparazione e per legature	76	Forbice per bendaggi	118	Divaricatore per palpebre	106
ADSON-BROWN Pinze delicate	27	BEYER Pinza-sgorbia	114	Divaricatori	92-106
ADSON HALSTED		BIRKETT Pinze emostatiche	71	DIXON PEAN Pinze emostatiche	67
Pinze emostatiche	70	Bisturi	2-3	DOUGLAS BOZEMANN	
ADSON MICRO Pinze delicate	26	BOEHLER WOLFF		Pinza per tamponamento	89
ADSON Pinze delicate	26	Pinze strappagessi	119	DOYEN Tiramiomi	143
ALLIS-BABY Pinza per afferrare intestino e tessuti	128	BOETTCHER SCHNIDT			
ALLIS Pinze per afferrare intestino e tessuti	128	Pinze emostatiche e tonsillari	78	<b>E</b>	
ARMYTAGE GREEN		BOZEMANN-DOUGLAS		EDNA (LORNA) Pinze fissatele	80
Pinza serra-utero	152	Pinza per tamponamento	89	ESMARCH Forbice per bendaggi	118
		BOZEMANN			
<b>B</b>		Pinze per tamponamento	88	<b>F</b>	
BABCOCK Pinze per afferrare intestino e tessuti	129	BRAUN SIMPSON		FARABEUF-BABY Divaricatore	96
BABY ADSON Pinze per preparazione e per legature	76	Forcipe per ostetricia	155	FARABEUF Divaricatore	96
BABY ALLIS Pinza per afferrare intestino e tessuti	128	BRAUN-STADLER		FEILCHENFELD Pinze per schegge	36
BABY BALFOUR		Forbice perineale	152	FOERSTER (BALLENGER)	
Pivaricatore addominale	110	BROWN ADSON Pinze delicate	27	Pinze per spugne	86
BABY CRILE-WOOD Port'aghi	49, 50	BRUNS Pinza per bendaggi	118	FOERSTER Pinze per spugne	86, 87
BABY GELPI Divaricatore	109	BUCK Martello per diagnostica	126	Forbici	6-21
BABY-FARABEUF Divaricatore	96	BURKE		Forbici chirurgiche	10-12
BABY-METZENBAUM		Pinza per biopsia ginecologica	148	Forbici delicate	6-9
Forbici per preparazione	16, 17	BUSCH Forbice per il cordone ombelicale	153	Forbici Iris	7
BABY MIXTER Pinze per preparazione e per legature	76	<b>C</b>		Forbici per bendaggi	118
BABY-MOSQUITO HARTMANN		CHAPUT Pinza emostatica e per afferrare tessuti	79	Forbici per fili d'acciaio	21
Pinze emostatiche	57	COLLEGE LONDON Pinze dentali	35	Forbici per gesso	120
BABY-OVERHOLT Pinza per preparazione e per legature	74	COLLIN Pinza emostatica e per afferrare tessuti	79	Forbici per legature	20
BABY PEAN Pinze emostatiche	57	COTTLE Specolo nasale	160	Forbici per operazione e preparazione	13-15
BABY-TISCHLER		CRILE Pinze emostatiche	61	Forbici per preparazione	13-19
Pinza per biopsia ginecologica	149	CRILE-RANKIN Pinze emostatiche	61	Forbici perineali	152
BACKHAUS Pinze fissatele	80	CRILE-WOOD BABY Port'aghi	49, 50	Forcipi per ostetricia	154-156
BALFOUR-BABY		CRILE-WOOD Port'aghi	49, 50	FOX Forbici delicate	9
Divaricatore addominale	110	Cucchiaino per calcoli biliari	136	FRAZIER (FERGUSSON)	
BALFOUR		Cucchiaino tagliente	112	Strumento per aspirazione	40
Divaricatore addominale	110	Curette uterine	144-145	FRAZIER Strumenti per aspirazione	40
BALLENGER FOERSTER		CUSCO Specolo vaginale	140	FRIEDMANN Pinza-sgorbia	113
Pinze per spugne	86	CUSHING Pinze anatomiche	32		
Batterie per manici laringoscopi	171	CUSHING Pinze chirurgiche	32	<b>G</b>	
BAUMGARTNER Port'aghi	47	<b>D</b>		GEISSENDOERFER OVERHOLT	
BECKMANN		DANDY Pinze emostatiche	67	Pinze per preparazione e per legature	75
Divaricatore autostatico	109	DEAVER Divaricatore	103-105	GELPI-BABY	
BEEBEE Forbici per fili d'acciaio	21	DEAVER Forbici chirurgiche	12	Divaricatore autostatico	109
BENGOLEA Pinze emostatiche	72	DEBAKEY Pinze atraumatiche	30-31	GEMINI Pinze per preparazione e per legature	77
		DESJARDINS		GERALD Pinza anatomica	32
		Cucchiaino per calcoli biliari	136	GERALD Pinza chirurgica	32
		DESMARRES		GILLIES Pinza delicata	27
		Divaricatore per palpebre	106	GILLIES Uncino dermatologico e per dura-madre	93
		Divaricatore addominale	110	GRAVES Specolo vaginale	140

## Indice alfabetico

GREEN-ARMYTAGE		KELLY Sfinteroscopi	133	MAYO Forbici per	
Pinza serra-utero	152	KEVORKIAN TISCHLER		operazione e preparazione	13
GROSS Pinze per medicazione	84, 85	Pinza per biopsia ginecologica	148	MAYO-HEGAR Port'aghi	48
GRUENWALD		KEVORKIAN-YOUNGE		MAYO-LEXER Forbici per	
Pinze a forma di baionetta	34	Pinza per biopsia ginecologica	150	operazione e preparazione	15
<b>H</b>		KIELLAND Forcipe per ostetricia	156	MAYO-STILLE Forbici per	
HALLE HARTMANN		KOCHER Divaricatore	102	operazione e preparazione	14
Specolo nasale	158	KOCHER Pinze emostatiche	66	MCGIVNEY	
HALSEY Port'aghi	46, 47	KOCHER Pinze intestinali	130-131	Pinza per afferrare emoroidi	133
HALSTED (ADSON)		<b>L</b>		MCINDOE Pinza delicata	27
Pinze emostatiche	70	LAHEY Pinza per preparazione		MCINTOSH Laringoscopi	162, 167
HALSTED MICRO		e per legature	74	MERIAM Pinze dentali	35
Pinze emostatiche	56	Lame per bisturi	2	METZENBAUM BABY	
HALSTED-MOSQUITO		Lame per laringoscopi con conduttore		Forbici per preparazione	16,17
Pinze emostatiche	58	d'illuminazione a luce fredda	162-164	METZENBAUM	
HARTMANN (BABY-MOSQUITO)		Lame per laringoscopi con		Forbici per preparazione	16, 17
Pinze emostatiche	57	lampadina	167-169	METZENBAUM-slim	
HARTMANN-HALLE		Lampadina alogena per manici per		Forbici per preparazione	19
Specolo nasale	158	laringoscopi	165	MICHEL	
HARTMANN MICRO		Lampadine di ricambio per lame di		Strumenti per applicare fermagli	53
Pinze emostatiche	56	laringoscopio	167-169	MICRO-ADSON Pinze delicate	26
HARTMANN		LANGENBECK Divaricatore	102	MICRO-HALSTED	
Pinza auricolare	161	LANGENBECK PARKER (US-ARMY)		Pinze emostatiche	56
HEGAR MAYO Port'aghi	48	Divaricatore	98	MICRO-HARTMANN	
HEGAR OLSEN Port'aghi	51	Laringoscopi	162-171	Pinze emostatiche	56
HEISS Pinze emostatiche	70	Laringoscopi con conduttore		MICRO-IRIS Forbici	7
HENNIG Allargagessi	119	d'illuminazione a luce fredda	162-166	MILLER Laringoscopi	164, 169
HOSPITAL PRESBYTERIAN		LERICHE Pinze emostatiche	59	MILLER SENN Divaricatore	92
Pinze serratubi	82	LEXER MAYO Forbici per		MIXTER Forbici chirurgiche	12
HUDSON (EWALD)		operazione e preparazione	15	MIXTER-BABY Pinze per	
Pinze delicate	26	LISTER Forbici per bendaggi	118	preparazione e per legature	76
HUNTER Pinze per schegge	36	LISTER Pinze per medicazione	84	MIXTER Pinze per preparazione	
<b>I</b>		LISTON Pinze ossivore	116	e per legature	77
Indice alfabetico	170-189	LITTAUER Forbice per legature	20	MOD. USA Allargagessi	119
Indice numerico	163-168	LONDON-COLLEGE Pinze		MOD. USA Pinza per il	
Iris forbici	7	dentali	35	cordono ombelicale	153
IRIS MICRO Forbici	7	LUCAE Pinza a forma di baionetta	34	MOD. WIEN Specolo nasale	159
IRIS STANDARD Forbici	7	LUER Pinza-sgorbia	113	MORGAN TISCHLER	
Isterometri	141	LUER STILLE Pinze-sgorbie	115	Pinza per biopsia ginecologica	150
<b>J</b>		<b>M</b>		MOSQUITO HALSTED	
JANSEN ZAUFAL Pinza-sgorbia	114	MAGILL		Pinze emostatiche	58
JOSEPH Divaricatore		Pinze per introdurre cateteri	126	<b>N</b>	
e uncino dermatologico	94	MAIER Pinze per medicazione	84, 85	NAEGELE Forcipe	
<b>K</b>		Manici per bisturi	3	per ostetricia	155
KELLY Forbici delicate	9	Manici per laringoscopi	165-166,170	NEIVERT Port'aghi	45
KELLY Pinze emostatiche	60	Manico per laringoscopio con diodo		NELSON (METZENBAUM)	
KELLY RANKIN Pinze emostatiche	60	luminescente	166	Forbici per preparazione	18
		Manico per laringoscopio con		<b>O</b>	
		raccordo di trasformatore	170	OCHSNER ROCHESTER	
		Martelli per diagnostica	126	Pinze emostatiche	68-69
		MATHIEU Port'aghi	52	OLSEN-HEGAR Port'aghi	51

## Indice alfabetico

OVERHOLT BABY Pinza per preparazione e per legature	74	Pinze per preparazione e per legature	73-77	Pinza per il collo gin.	142
OVERHOLT-GEISSENDOERFER Pinze per preparazione e per legature	75	Pinze per schegge	36, 37	SCHUBERT Pinze per biopsia ginecologiche	146
OVERHOLT Pinze per preparazione e per legature	73	Pinze per spugne	86-87	SCHUMACHER-VAN DOREN Pinze per biopsia ginecologiche	147
<b>P</b>		Pinze per tamponamento	88-89	Sega per anelli	123
PARKER Divaricatore	97	Pinze per unghie	122-123	SEMKEN Pinze delicate	28
PARKER-LANGENBECK (US-ARMY) Divaricatore	98	Pinze serrapene	138	SENN-MILLER Divaricatore	92
PEAN-BABY Pinze emostatiche	57	Pinze serratubi	81-82	Set di laringoscopi	162-164, 167-169
PEAN-DIXON Pinze emostatiche	67	Pinze strappagessi	119	Sfinteroscopi	133
PEAN Pinze emostatiche	59, 66	Pinze tonsillari	78	SIMPSON-BRAUN Forcipe per ostetricia	155
PEAN ROCHESTER Pinze emostatiche	64-65	Pinze-sgorbie	113-115	SIMPSON Forcipi per ostetricia	154, 155
PEDERSON Specolo vaginale	140	PIPER Forcipe per ostetricia	156	SIMS Isterometri	141
PEET Pinza per schegge	37	POOLE Strumenti per aspirazione	41	SIMS Specolo rettale	132
PENNINGTON Pinze emostatiche e per afferrare tessuti	79	Port'aghi	44-52	SIMS Specolo vaginale	141
Pinza allargagessi	119	Port'aghi TC spiegazioni	44	SMITH POTTS Pinze anatomiche	29
Pinza auricolare	161	POTTS-SMITH Pinze anatomiche	29	SMITH POTTS Pinze chirurgiche	29
Pinza per afferrare emoroidi	133	POTTS-SMITH Pinze chirurgiche	29	Specolo nasale	158-160
Pinza per il cordone ombelicale	153	POZZI Pinza ginecologica per il collo	142	Specolo rettale	132
Pinza per introdurre cateteri	126	PRATT Specolo rettale	132	Specolo vaginale	140-141
Pinza serra-utero	152	PRESBYTERIAN-HOSPITAL Pinze serratubo	82	SPENCER Forbici per legature	20
Pinze	24-35	<b>R</b>		SPENCER-WELLS Pinze emostatiche	62-63
Pinze	56-82	RALK Pinza per schegge	37	STADLER BRAUN Forbice perineale	152
Pinze a forma di baionetta	34	RANDALL Pinze per calcoli renali	137	STEVENS Forbici delicate	8
Pinze anatomiche	24, 29, 32	RANKIN CRILE Pinze emostatiche	61	STIEGLITZ (WILLIAMS) Pinze per schegge	37
Pinze atraumatiche	30-31	RANKIN-KELLY Pinze emostatiche	60	STILLE Forbici per gesso	120
Pinze chirurgiche	25, 29, 32	RECAMIER Curette uterine	144-145	STILLE-LUER Pinze-sgorbie	115
Pinze delicate	26-28	Ricaricatore per accumulatore per laringoscopi	171	STILLE MAYO Forbici per operazione e preparazione	14
Pinze dentali	35	Ricaricatore per manici per laringoscopio	166, 170	STOCKMANN Pinze serrapene	138
Pinze emostatiche	56-72, 78-79	ROBERTS Pinze emostatiche	71	STRAUSS Pinza serrapene	138
Pinze fissatele	80	ROCHESTER-OCHSNER Pinze emostatiche	68-69	Strumenti per applicare fermagli	53
Pinze ginecologiche per il collo	142	ROCHESTER-PEAN Pinze emostatiche	64-65	Strumenti per aspirazione	40-41
Pinze intestinali	130-131	ROUX Divaricatore	98	Strumenti per gesso	119-120
Pinze ossivore	116	RUSKIN Pinza-sgorbia	114	<b>T</b>	
Pinze per afferrare intestino	128-129	RUSS. MOD. Pinza per afferrare tessuti	33	TAYLOR Martello per diagnostica	126
Pinze per afferrare intestino e tessuti	128-129	<b>S</b>		TC port'aghi	45-48, 50-52
Pinze per afferrare tessuti	33, 79, 128-129	SAWTELL SCHNIDT Pinze emostatiche e tonsillari	78	TC port'aghi spiegazioni	44
Pinze per biopsia ginecologiche	146-150	SCHAEDEL Pinza fissatele	80	Tiramiomi	143
Pinze per calcoli renali	137	SCHNIDT (BOETTCHER) Pinze emostatiche e tonsillari	78	TISCHLER BABY Pinza per biopsia ginecologica	149
Pinze per legature	73-77	SCHNIDT (SAWTELL) Pinze emostatiche e tonsillari	78	TISCHLER-KEVORKIAN Pinza per biopsia ginecologica	148
Pinze per medicazione	84-85	SCHROEDER		TISCHLER-MORGAN Pinza per biopsia ginecologica	150
Pinze per preparazione	73-77			TISCHLER Pinza per biopsia ginecologica	149

Trasformatore per manico laringosco-  
pio 170  
TROELTSCH (WILDE)  
Pinza a forma di baionetta 34  
Tronchesine per unghie 123  
TUFFIER Pinza emostatica  
e per afferrare tessuti 79

**U**

Uncini dermatologici 93, 94  
Uncini dermatologici  
e per dura-madre 93  
Uncini tracheali 95  
UNIVERSAL  
Forbice per fili d'acciaio 21

**V**

VAN DOREN  
Pinza per biopsia ginecologica 147

VAN DOREN SCHUMACHER  
Pinze per biopsia ginecologica 147  
VOLKMANN Cucchiaino tagliente 112  
VOLKMANN Divaricatore 99-101

**W**

WAGNER Forbici delicate 6  
WALDMANN Forbice perineale 152  
WEBSTER Port'aghi 45  
WEITLANER  
Divaricatore autostatico 108  
WELLS SPENCER  
Pinze emostatiche 62-63  
WISCONSIN WIS-FOREGGER  
Laringoscopi 163, 168  
WIS-FOREGGER (WISCONSIN)  
Laringoscopi 163, 168  
WOLFF-BOEHLER  
Pinze trappagessi 119

WOOD CRILE BABY  
Port'aghi 49, 50  
WOOD CRILE Port'aghi 49, 50  
WRIGHT (DERF) Port'aghi 46  
WRIGLEY Forcipe per ostetricia 154

**Y**

YANKAUER  
Strumento per aspirazione 41  
YOUNGE KEVORKIAN  
Pinza per biopsia ginecologica 150

**Z**

ZAUFAL-JANSEN  
Pinza-sgorbia 114

**bob**  
instruments

---

best of basic instruments



bob instruments GmbH  
Weilatten 10, D-78532 Tuttlingen  
Postfach 40 35, D-78505 Tuttlingen  
Germany

Phone: +49 (0) 7462 / 94 48-0  
Fax: +49 (0) 7462 / 94 48-50  
E-Mail: [info@bob-instruments.de](mailto:info@bob-instruments.de)  
[www.bob-instruments.de](http://www.bob-instruments.de)